

# FS-i6S

USER MANUAL

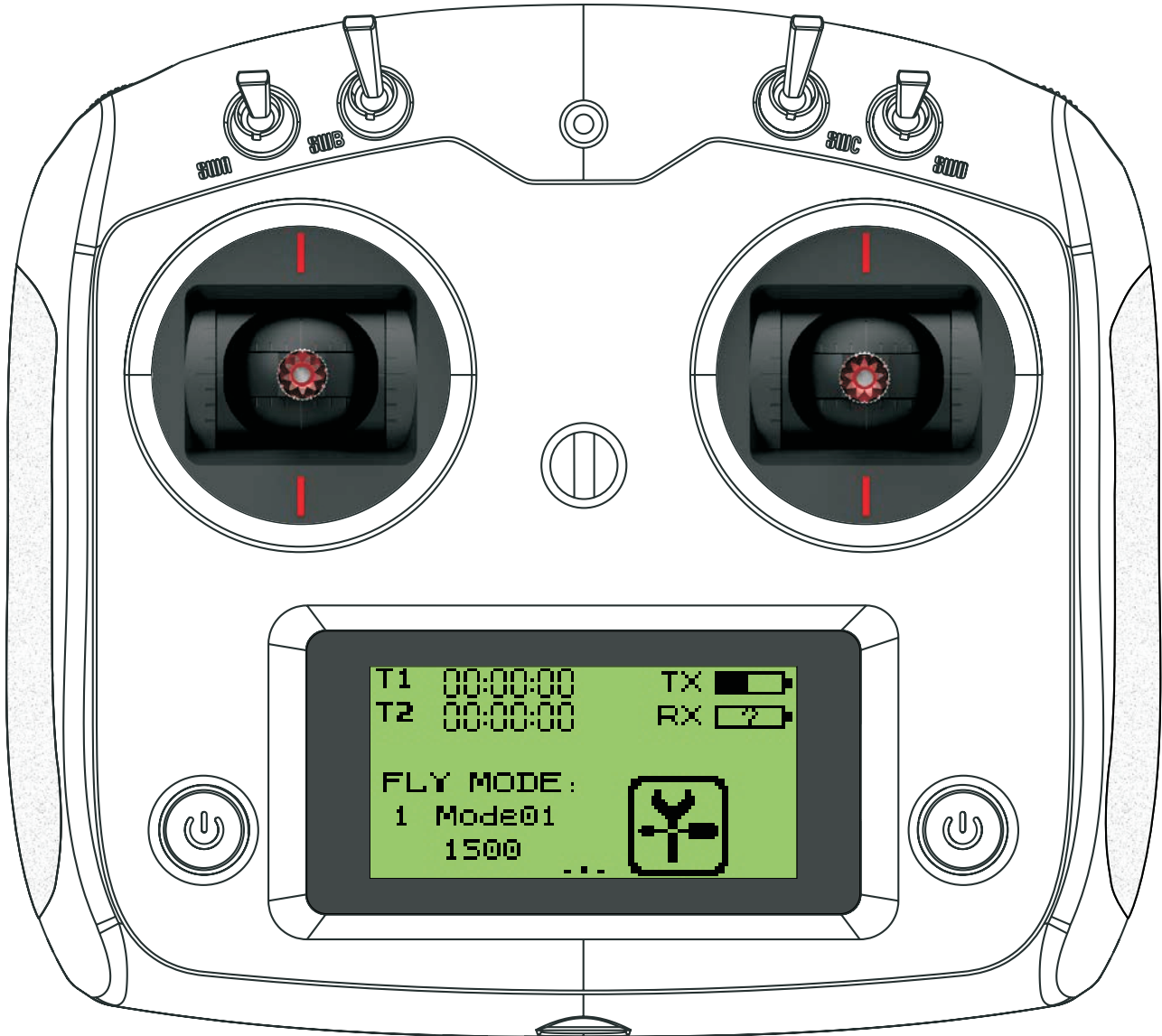

## Digital Proportional Radio Control System



Copyright ©2015-2016 Flysky RC model technology co., ltd

**CE 0678**  
FCC ID:N4ZFLYSKYI6S

**2.4GHz**  
**AFHDS 2A**



**WARNING:**  
This product is only for 15 years old or above



Thank you for purchasing our product, an ideal radio system for beginners or experienced users alike.

Read this manual carefully before operation in order to ensure your safety, and the safety of others or the safe operation of your system.

If you encounter any problem during use, refer to this manual first. If the problem persists, contact your local dealer or visit our service and support website for help:

**<http://www.flysky-cn.com>**

# Contents

<b>1. Safety</b>	<b>1</b>
1.1 Safety Symbols	1
1.2 Safety Guide	1
<b>2. Introduction</b>	<b>2</b>
2.1 System Features	2
2.2 Transmitter Overview	3
2.2.1 Transmitter Antenna	4
2.2.2 Stick/Knob/Switch/Key	4
2.2.3 Status Indicator	4
2.2.4 USB Simulator Mode	5
2.2.5 PS/2 Port	5
2.3 Receiver Overview	5
2.3.1 Receiver Antenna	5
2.3.2 Status Indicator	5
2.3.3 Connectors	5
<b>3. Getting Started</b>	<b>6</b>
3.1 Transmitter Battery Installation	6
<b>4. Operation Instructions</b>	<b>7</b>
4.1 Power On	7
4.2 Binding	7
4.3 Pre-use Check	7
4.4 Power Off	8
<b>5. System Interface</b>	<b>9</b>
5.1 Home Screen	9
5.2 Timers	9
5.3 Fly Mode	10
5.4 TX/RX Battery	11
5.5 Display Servos	11
5.6 Display Sensors	11
<b>6. Function Settings</b>	<b>12</b>
6.1 Reverse	12
6.2 End Points	12
6.3 Subtrim	12
6.4 Trims	13
6.5 Rate/Exp.	13
6.6 Throt Curve	13
6.7 Aux. Channels	14
6.8 Mix	14
6.9 Failsafe	14
<b>7. System Settings</b>	<b>15</b>
7.1 RX Bind	15
7.2 Models	15
7.3 Output Mode	15

7.4 Sticks Mode .....15  
7.5 Sticks Adjust .....16  
7.6 Bri./Sound .....16  
7.7 Factory Reset .....16  
7.8 Firmware Update .....16  
7.9 About FS-i6S .....16

**8. Device Holder (optional).....17**

**9. Product Specifications.....19**

9.1 Transmitter Specifications ( FS-i6S ) .....19  
9.2 Receiver Specifications ( FS-X6B ) .....19

**10. Package Contents.....20**



**Appendix 1 FCC Statement .....21**



# 1. Safety

## 1.1 Safety Symbols

Pay close attention to the following symbols and their meanings. Failure to follow these warnings could cause damage, injury or death.

	<b>Danger</b>	• <b>Not following these instructions may lead to serious injuries or death.</b>
	<b>Warning</b>	• <b>Not following these instructions may lead to major injuries.</b>
	<b>Attention</b>	• <b>Not following these instructions may lead to minor injuries.</b>

## 1.2 Safety Guide



**Prohibited**



**Mandatory**



- **Do not use the product at night or in bad weather like rain or thunderstorm. It can cause erratic operation or loss of control.**
- **Do not use the product when visibility is limited.**
- **Do not use the product on rain or snow days. Any exposure to moisture (water or snow) may cause erratic operation or loss of control.**
- **Interference may cause loss of control. To ensure the safety of you and others, do not operate in the following places:**
  - Near any site where other radio control activity may occur
  - Near power lines or communication broadcasting antennas
  - Near people or roads
  - On any pond when passenger boats are present
- **Do not use this product when you are tired, uncomfortable, or under the influence of alcohol or drugs. Doing so may cause serious injury to yourself or others.**
- **The 2.4GHz radio band is limited to line of sight. Always keep your model in sight as a large object can block the RF signal and lead to loss of control.**
- **Never grip the transmitter antenna during operation. It significantly degrades signal quality and strength and may cause loss of control.**
- **Do not touch any part of the model that may generate heat during operation, or immediately after use. The engine, motor or speed control, may be very hot and can cause serious burns.**







- **Misuse of this product may lead to serious injury or death. To ensure the safety of you and your equipment, read this manual and follow the instructions.**
- **Make sure the product is properly installed in your model. Failure to do so may result in serious injury.**
- **Make sure to disconnect the receiver battery before turning off the transmitter. Failure to do so may lead to unintended operation and cause an accident.**
- **Ensure that all motors operate in the correct direction. If not, adjust the direction first.**
- **Make sure the model flies within a certain distance. Otherwise, it would cause loss of control.**

## 2. Introduction

The FS-i6S transmitter and FS-X6B receiver constitute a 2.4GHz AFHDS 2A digital proportional computerized R/C system. This system supports quadcopter.

### 2.1 System Features

The AFHDS 2A (Automatic Frequency Hopping Digital System Second Generation) developed and patented by FLYSKY is specially developed for all radio control models. Offering superior protection against interference while maintaining lower power consumption and high reliable receiver sensitivity, FLYSKY's AFHDS technology is considered to be one of the leaders in the RC market today.

	<b>Bidirectional Communication</b> Capable of sending and receiving data, each transmitter is capable of receiving data from temperature, altitude and many other types of sensors, servo calibration and i-BUS Support.
	<b>Multi-channel Hopping Frequency</b> This systems bandwidth ranges from 2.4055GHz to 2.475GHz. This band is divided in 140 channels. Each transmitter hops between 16 channels (32 for Japanese and Korean versions) in order to reduce interference from other transmitters.
	<b>Omni-directional Gain Antenna</b> The high efficiency Omni-directional high gain antenna cuts down on interference, while using less power and maintaining a strong reliable connection.
	<b>Unique ID Recognition System</b> Each transmitter and receiver has it's own unique ID. Once the transmitter and receiver have been paired, they will only communicate with each other, preventing other systems accidentally connecting to or interfering with the systems operation.
	<b>Low Power Consumption</b> The system is built using highly sensitive low power consumption components, maintaining high receiver sensitivity, while consuming as little as one tenth the power of a standard FM system, dramatically extending battery life.

## 2.2 Transmitter Overview

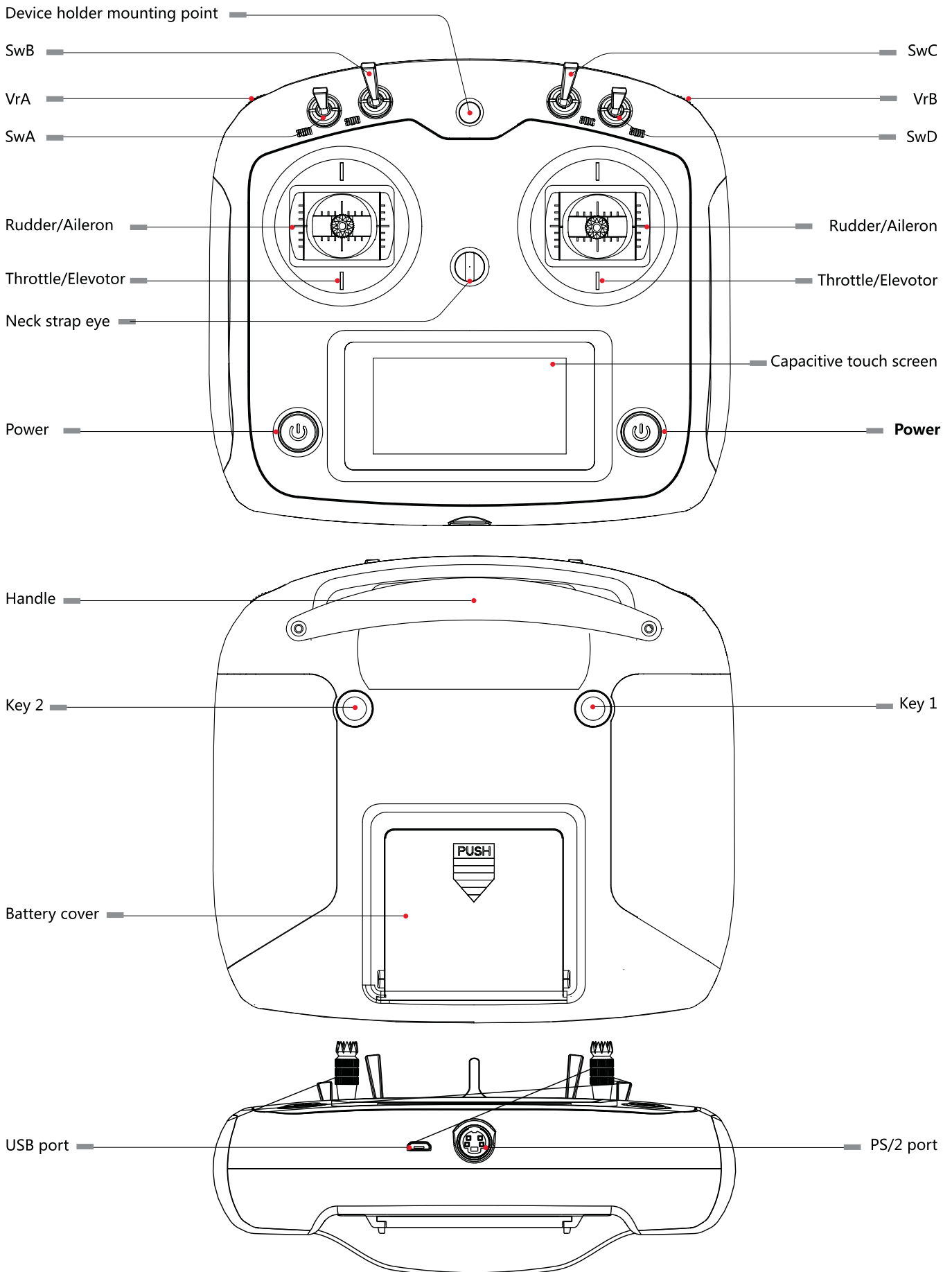

## 2.2.1 Transmitter Antenna

FS-i6S transmitter has a built-in dual antenna.



### Note

- Never grip the transmitter antenna during operation. It significantly degrades the RF signal quality and strength and may cause loss of control.

## 2.2.2 Stick/Knob/Switch/Key

The FS-i6S has 2 sticks, 2 knobs, 4 switches and 2 keys.

- Stick: Used to control aileron, elevator, throttle and rudder.
- Switch: Controls aux. channels.
- Used to control aux. channels or function parameters.
- Key: Used to control aux. channels, function parameters or timers.

## 2.2.3 Status Indicator

The status indicator is used to indicate the power and working status of the transmitter.

- Off: The transmitter is powered off.
- Blue light: The transmitter is on and working.

## 2.2.4 USB Simulator Function

The system can be connected via a USB cable to a computer for use as a HID device. This function is automatically activated when connected to a computer and will be recognised as a standard HID controller.



### Caution

- **If the computer does not recognise the transmitter unplug and reconnect the USB cable.**

## 2.2.5 PS/2 Port

This port enables PPM output.

## 2.3 Receiver Overview

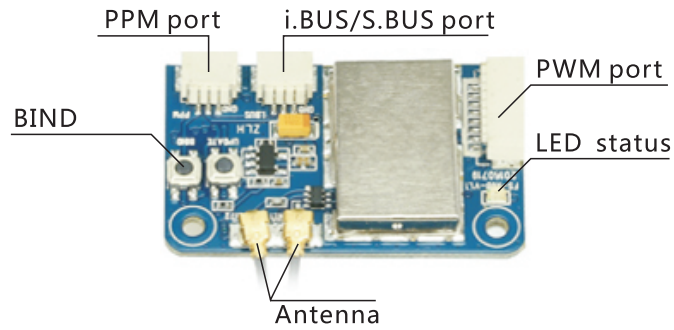

### 2.3.1 Receiver Antenna

The FS-X6B has a dual 100 mm antenna.

	<b>Caution</b>	<ul style="list-style-type: none"><li>• <b>For best signal quality, ensure that the receiver is mounted away from motors or metal parts.</b></li></ul>
---	----------------	--

### 2.3.2 Status Indicator

The status indicator is used to indicate the power and working status of the receiver.

- light off : receiver power is not connection
- red light is on : receiver is connected and normal working
- Blink quickly : receiver is bind status
- Blink slowly : the transmitter not power on or signal has been lost

### 2.3.3 Connectors







The connectors are used to connect the parts of model and the receiver.

- PPM port : output PPM signal
- i.BUS/S.BUS port : output i.BUS/S.BUS signal
- PWM Receiver : output PPM receiver signal
- Bind port : used for receiver and transmitter bind

## 3. Getting Started

Before operation, install the battery and connect the system as instructed below.

### 3.1 Transmitter Battery Installation

	<b>Danger</b>	• Only use specified battery.
	<b>Danger</b>	• Do not open, disassemble, or attempt to repair the battery.
	<b>Danger</b>	• Do not crush/puncture the battery, or short the external contacts.
	<b>Danger</b>	• Do not expose to excessive heat or liquids.
	<b>Danger</b>	• Do not drop the battery or expose to strong shocks or vibrations.
	<b>Danger</b>	• Always store the battery in a cool, dry place.
	<b>Danger</b>	• Do not use the battery if damaged.

Follow the steps to install the transmitter battery:

1. Open the battery compartment.
2. Insert 4 fully-charged AA batteries into the compartment. Make sure that the battery makes good contact with the battery compartment's contacts.
3. Replace the battery compartment cover.



## 4. Operation Instructions

After setting up, follow the instructions below to operate the system.

### 4.1 Power On

Follow the steps below to turn on the system:

1. Check the system and make sure that:
  - The batteries are charged and installed properly.
  - The receiver is off and correctly installed.
2. Hold the power buttons until screen lights up.
3. Connect the receiver power supply to the **B/VCC** port on the receiver.

	<b>Note:</b>	• <b>Operation with caution in order to avoid damage or injury.</b>
	<b>Note:</b>	• <b>Make sure that the throttle is at its lowest position and the switches are set to their up position.</b>

### 4.2 Binding

The transmitter and receiver have been pre-bound before delivery



If you are need reset the bind , follow the steps below to bind the transmitter and receiver

1. Turn the transmitter on , press  to setting button, click SYS into SYSTEM menu , and scroll down and then select RX bind
2. Press the receiver 's Bind button , turn the receiver on
3. The receiver red lights flash 3 times then constantly on , transmitter screen showed "Bind ok " that bind has been successful
4. Checked the transmitter , receiver , and drone , if anything does not work as expected , restart this procedure from the beginning

### 4.3 Pre-use Check

Before operation, perform the following steps to check the system:

1. Check to make sure that all servos and motors are working as expected.
2. Check operating distance: one operator holds the transmitter, and another one moves the model away from the transmitter. Check the model and mark the distance from where the model starts to lose control.

	<b>Danger</b>	• <b>Stop operation if any abnormal activity is observed.</b>
	<b>Danger</b>	• <b>Make sure the model does not go out of range.</b>
	<b>Attention</b>	• <b>Sources of interference may affect signal quality.</b>

## 4.4 Power Off

Follow the steps below to turn off the system:

1. Disconnect the receiver power.
2. Hold the transmitter's power buttons to turn off the transmitter.



**Danger**

- **Make sure to disconnect the receiver power before turning off the transmitter. Failure to do so may lead to damage or serious injury.**



## 5. System Interface

The system interface displays useful information about your model, including timers, fly mode and TX/RX status.

### 5.1 Home Screen

The main interface displays model.

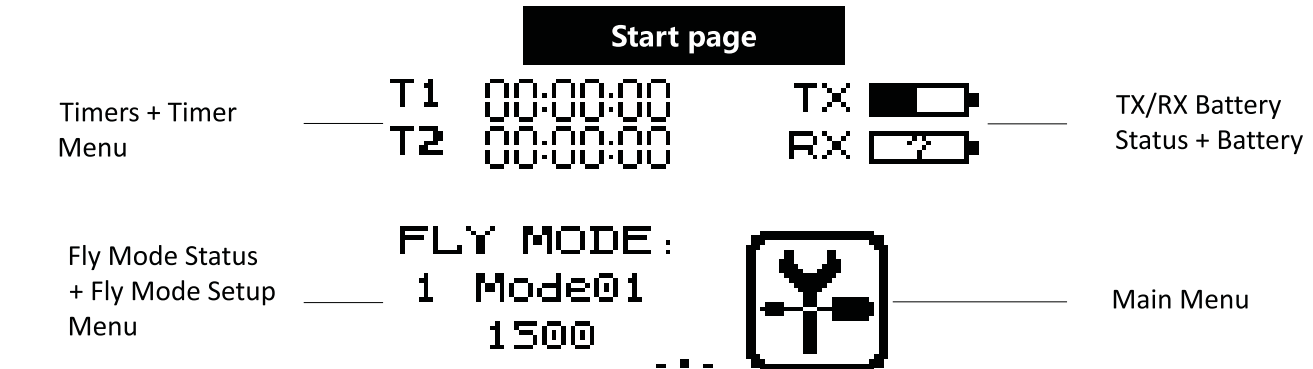

Swipe to the right to display the servo interface

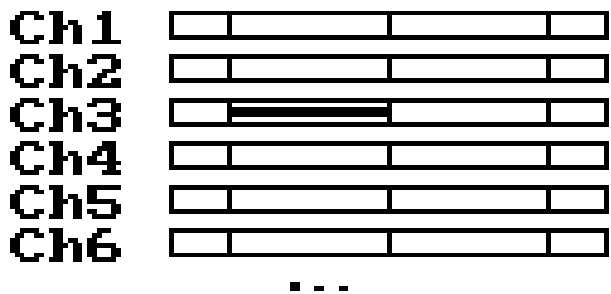

Swipe left to display the sensors

Name	ID	Value
TX. U	0	4.99U

There are three dots below the table, indicating more sensors.

### 5.2 Timers

This function can set 2 timers at the same time. Usually used to keep track of total flight time.

**Setup :**

To enter the timer function touch T1/T2 on the main screen. The system has 2 timers available, both can be assigned to a switch and have 3 different settings.

Setup:

- Select a mode.
  - Up: The up timer starts from zero and counts up.
  - Down: The down timer starts from a pre selected time and counts down.
  - D/U(Down then up): The D/U timer starts from down to 0 from a preset time, then starts counting up again.
- If necessary set up the pre defined time by selecting the **[Setup]** option. Select the correct decimal and use the onscreen arrow keys to change the value.

# Digital Proportional Radio Control System FS-i6S

3. Touch **[Switch]** to enter the switch selection sub menu. If no switch is selected you can press **[Start]** to start the time and **[Stop]** to stop it.

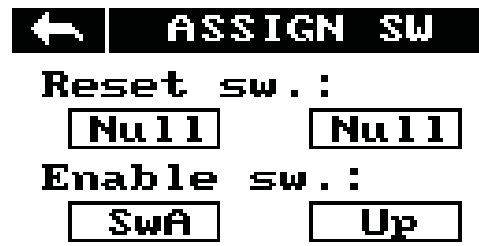
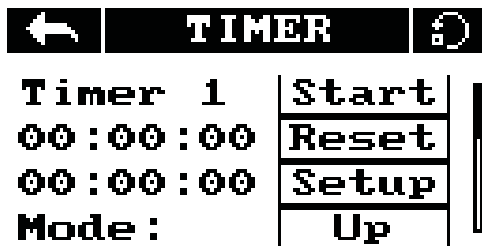

## 5.3 Fly Mode

The fly mode function can store up to 9 different fly modes which can be activated using a switch.

### Setup:

This mode can store settings that can be recalled by toggling a switch.

There are several options available:

A: Stores the channel used by the flight controller.

1. Touch the box to the right of the desired channel.
2. Select the correct decimal and use the up and down arrow keys.

B: Stores the first selected activation switch.

C: Stores the second selected activation switch.

D: This number represents the currently selected mode. The name beside the mode number can be changed.

Touch the box, use the onscreen keyboard to enter a new name.

E: Changes the output for each mode.

1. Touch the box to the right of the desired channel.
2. Select the correct decimal and use the up and down arrow keys.

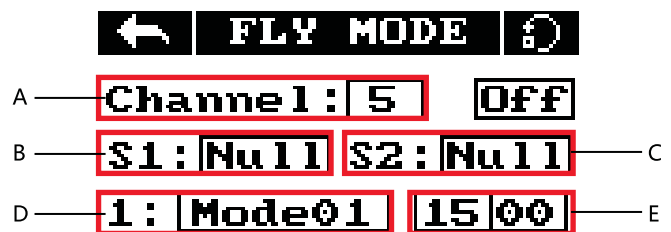

Different fly modes are assigned using combinations of switches. A 2-way switch will enable you to switch between modes 1 and 2, two 2-way switches will enable you to 4 fly modes, two 3-way switches will allow you to switch between all 9 fly modes. Use the table below to learn which positions are assigned to each mode.

SwB Position	SwC Position	Mode
Up	Up	1
Up	Middle	2
Up	Down	3
Middle	Down	4
Middle	Middle	5
Middle	Up	6
Down	Up	7
Down	Middle	8
Down	Down	9

## 5.4 TX/RX Battery

This function sets up the receiver and transmitter low battery alarm.

### Setup:

1. Click on the TX/RX voltage icon to enter its sub-menu.
2. To edit each setting touch its box and use the on-screen arrows to change the value.
  - The alarm voltage is limited by the set low and high voltage settings. For example if the high voltage is set to 6V and the low 4V then the alarm must be set between 4.1V and 5.9V.
  - When the voltage drops below the alarm voltage the system will alert the user via an audio alarm and an on-screen warning.

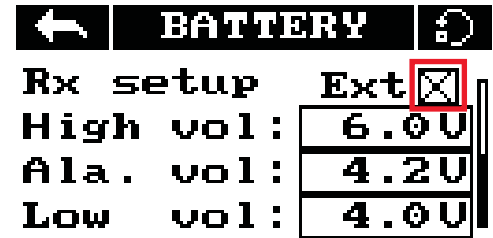

## 5.5 Display Servos

This function displays channel position in real time.  
All changes to channel's functions will be displayed here also.

### Setup:

1. Turn on the transmitter and swipe right on the screen.
2. To scroll swipe up and down on the screen.
  - Hold your finger on the screen to activate the channel sweep function. The system will ask if you are sure, make sure that all motors are disconnected in order to prevent damage to the model or harming others.
3. To disable the channel sweep function touch or swipe the screen to the left or right.

## 5.6 Display Sensors

This function displays all connected sensor names, type, number in real-time.

**[Name]** Sensor name/type.

**[ID]** The system gives each sensor connected to the receiver an ID starting from 0 (Transmitter Voltage), so the first sensor attached to the receiver will have an ID of 1.

**[Value]** Displays the sensor output.

All data in this list is displayed in real time, when a sensor is connected or disconnected the system will update the list.

## 6. function Settings

This section details functions and their use.

### 6.1 Reverse

The reverse function changes a channels direction of movement in relation to its input. For example, if the blades are spinning in the wrong direction, pushing the model into the ground instead of taking off, this function can be used to correct this.



**Setup:**

To change between normal and reverse touch the box to the right side of the desired channel.

Nor = Normal, Rev = Reverse.

Select the  icon to save and return to the previous menu.

Press the  To reset the function to its default settings.

	REVERSE		
Ch1	Rev	Ch2	Nor
Ch3	Nor	Ch4	Nor
Ch5	Nor	Ch6	Nor
Ch7	Nor	Ch8	Nor
Ch9	Nor	Ch10	Nor

### 6.2 End Points



The end points function changes the range of movement available to a channel. This can be used to limit the tilt of the model, so that it is easier to control.

The left box is the low end points, the right box is the high end points, marked below as low being blue and red being high.

**Setup:**

1. Touch the low or high end points box.
2. Touch the desired decimal to change then use the onscreen up and down arrows to change the value.



	END POINTS		
Ch1	100%	100%	
Ch2	100%	100%	
Ch3	100%	100%	
Ch4	100%	100%	
Ch5	100%	100%	



### 6.3 Subtrim

Subtrim changes the center point of the channel. For example, if a model is always drifting to one side, the sub trim can be used to fix this.

**Setup:**

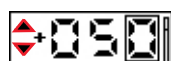
1. Touch the box to the right of the desired channel.
2. Select the correct decimal and use the up and down arrow keys.



	SUBTRIM		
Ch1	0%		
Ch2	0%		
Ch3	0%		
Ch4	0%		
Ch5	0%		

## 6.4 Trims

The trims function changes the center point for the 4 stick axis. If a control surface does not match up exactly to its expected position the trim function can be used to bring it back into alignment.

- If the throttle is not self-centering, channel 3 can not be adjusted.

This function is for slight adjustments only, if parts of the model are still out of alignment consider adapting the model.

### Setup:

1. In the function menu select **[Trims]** , Select "On" to activate.
2. Go to the servo display screen:

To adjust the right stick: Hold key 1 then hold a sick on an axis to adjust in that direction, hold until the desired change has been made.

To adjust the left stick: Hold key 2 then hold a sick on an axis to adjust in that direction, hold until the desired change has been made.



At the servo display page. To adjust the right stick trim,...

## 6.5 Rate/Exp.

This function creates a curve for the stick inputs and outputs.

When applied to a channel this function will change the response curve.

Usually the entire range of the servo movement will be mapped in this function.

### Setup:

This function is only available on channels 1, 2 and 4, the selected channel is displayed under the back button.

**[Rate]** Changes the channel's range (100% being full range).

**[Exp.]** Changes the amount of curve in the sticks response.

The currently selected variable will be highlighted in black.

The X on the graph shows the sticks (switches and knobs) current position.

The Y axis represents the channels output.

Curve's create a non linear relationship between input and output.

1. Touch **[Rate/Exp.]** in the function menu.
2. Select **[Rate]** or **[Exp. ]**.
3. Click the **+** or **-** icons to change the value.

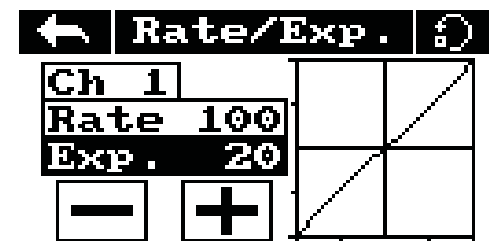

## 6.6 Throt Curve

The throttle curve function adds a curve to the throttle stick's input. This curve has 5 points that can be set to create a custom curve.

### Setup:

The X on the graph shows the sticks current position and output.

The X axis represents the current stick position and the Y axis displays

**[L]** Is represents the throttle at its 0 position.

The currently selected variable will be highlighted in black.

1. Touch **[Throt Curve]** in the function menu.
2. Select a point by touching it.
2. Click the **+** or **-** icons to change the value.

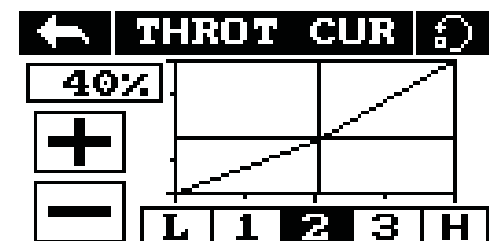

## 6.7 Aux. Channels

The auxiliary channels can be used to control additional part of a model such as landing gear or lights.

### Setup:

1. Select channels using the left or right arrow keys on the screen on either side of the channel name.
2. The left box below the channel name allows the user to pick the type of control for that channel, Nul, VRx, STx, KEY and SWx.
- If the channel is in use for a fly mode, the system will inform the user and prevent any changes to that channel.



## 6.8 Mix

The mix function creates a mix between 2 different channels. For example, it is possible to make a mix between rudder and ailerons, so whenever the model rolls, the rudder will move automatically to perform a turn.

### Setup:

**[Master]:** This channel will control the slave.

**[Slave]:** This channel is controlled by the master.

**[offset]:** Offset works like trim or sub trim allowing for the center position of the slave channel to be changed.

**[Pos.]:** Changes how much the slave will move in relation to the master in a positive movement. At 50% when the master moves to 100% of its positive motion, the slave will move to positive 50%.

**[Neg.]:** Changes how much the slave will move in relation to the master in a negative movement. At 50% when the master moves to 100% of its negative motion, the slave will move to negative 50%.

1. If the mix is not already disabled turn it off by touching the box labeled "on".
2. Select a master by touching the box to the right of the master channel and choose a channel from the list.
3. Select a slave by touching the box to the right of the slave channel, then choose a channel from the list.
4. If needed, set an offset on the slave channel. Select the box to the right of the offset function, select the correct decimal and use the up and down arrow keys to change the value.
5. Set the positive/negative ratio using the box to the right of "pos", select the correct decimal and use the up and down arrow keys to change the value.

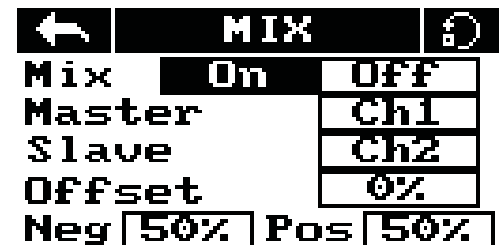

## 6.9 Failsafe

The failsafe function enables you to pre-set channel positions for the receiver in case of signal loss.

### Setup:

**[Ch1 : Off ]:** means that in case of a loss of signal, the corresponding servo will keep its last received position.

**[Ch3 : 100%]:** If it displays a percentage, the servo will instead move to the selected position.

1. To setup a failsafe position on a channel, select the channel from the list, to select the channel touch the box to the right of the channel name.
2. The box next to the channel name should display "On", to activate the failsafe touch the box. The box should now display "Off".
3. Move and hold the channel at the desired position, then while keeping the channel at the desired value touch the setup box.

You can set the failsafe position for all channels with the [All channels] button at once. To do so:

1. Turn all the channels on as stated above, hold all the channels in the desired position and select "Set all" at the bottom of the list.
2. The system will prompt for a conformation, select "Y" for yes.



## 7. System Settings

This chapter covers system functions.

### 7.1 RX Bind

This function is for binding a transmitter and receiver. For more information please refer to **[4.2 Binding]** .

### 7.2 Models

This function is for selecting and resetting models.

Setup :

1. Select **[Models]** From the system menu and use the left and right arrow icons to change between models.
2. To reset a model to factory default press **[Reset Model]**.
  - Model reset can not be undone.

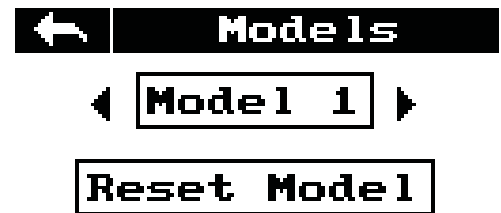

### 7.3 Output Mode

The system has two output modes, PWM and PPM. To change between the modes touch the desired mode, the currently selected mode will have a black dot.

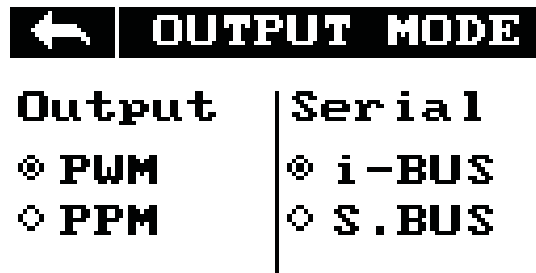

**[PWM]:** PWM output 1-6 channels outputting on the receivers 1-6 pins.

**[PPM]:** output 8 channel PPM signal ; Choose S.BUS , output 10 channel S.BUS signal.

### 7.4 Sticks Modes

The system has 4 stick modes to change from, to change the mode touch M1, 2, 3 or 4 on the right hand side of the screen. The currently selected mode is highlighted in black. Changing between modes 2/4 and 1/3 will necessitate changing the throttle gimbals position. The user will have to open up the product, see **[8.3 Swapping Gimbals]** for details.

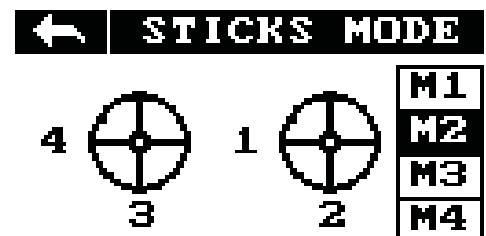
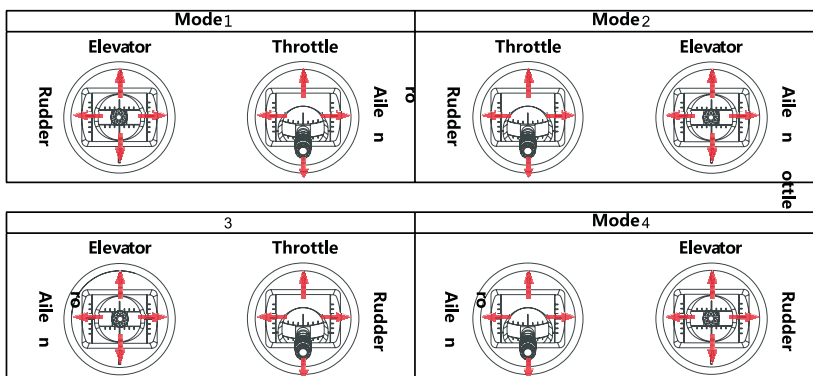

## 7.5 Sticks Adjust

This function calibrates the sticks and knobs.

### Setup:

1. Enter stick adjust in the manu.
2. Move the sticks and knobs through their entire range of motion on each axis. To save touch the back icon. If you can not go back it means that one or all of the sticks and knobs have not moved their full range of motion.
3. Go to the servo display screen to check the calibration.

## 7.6 Bri./Sound

This function controls screen brightness and volume for the system.

### Setup:

 Represents brightness ranging from 0-100%.

 Represents volume from 0-100%.

Touch **[Bri./Sound]** in the system menu. Touch the sliders to change screen brightness and volume.

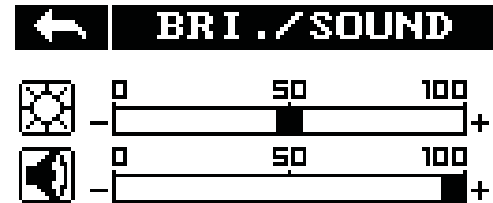

## 7.7 Factory Reset

This function resets all settings back to default.

To reset the system touch **[Factory Reset]** in the main menu then when prompted touch "Y" for yes.

- Once reset all user settings will be lost.

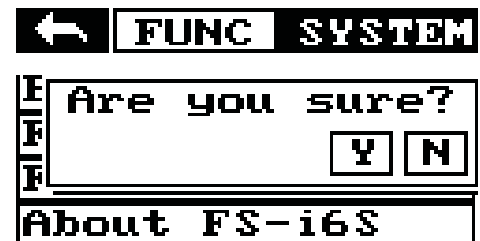

## 7.8 Firmware Update

This function is for updating the system firmware.

### Setup:

1. Download the latest firmware from <http://www.flysky-cn.com>.
2. Open the firmware update on a computer and connect the system via USB cable.
3. Select **[Firmware Update]** from the systems function menu. The system will show a prompt, "This will enter firmware update mode and halt other functions" with an option to continue, select "Y". When in update mode the screen will turn off.
4. Once the system has been recognized by the computer select the update button at the bottom of the firmware update software.
  - Once the system has been updated it will restart.
  - Once the system has restarted it is safe to remove the USB cable.

## 7.9 About FS-i6S

This menu shows the product name, hardware version, firmware release date and firmware version.



## 8. Device Holder (optional)

Mobile devices can be used in real time to receive information from an aircraft. For convince your device may be fitted into the mobile device bracket.

1

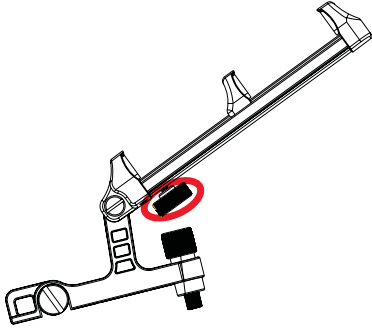

1. To adjust the bracket, loosen locking screw by turning it anti-clockwise.

2

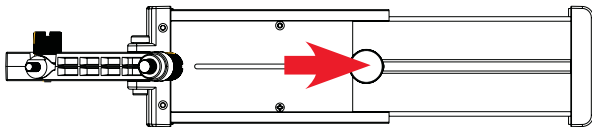

2. Slide the top part of the phone holder up.

3

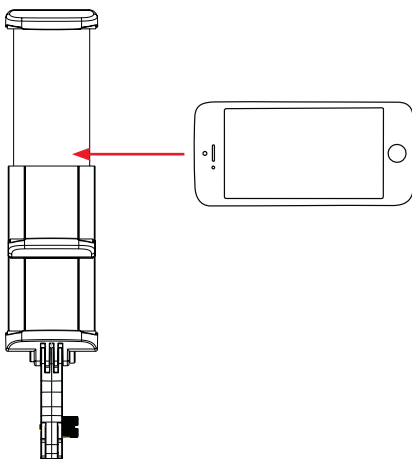

3. Place the phone/device in the middle of the bracket, be careful not to let the device fall.

4

4. Slide the bracket back down and tighten the locking screw. Make sure that the bracket has a firm grip.

5

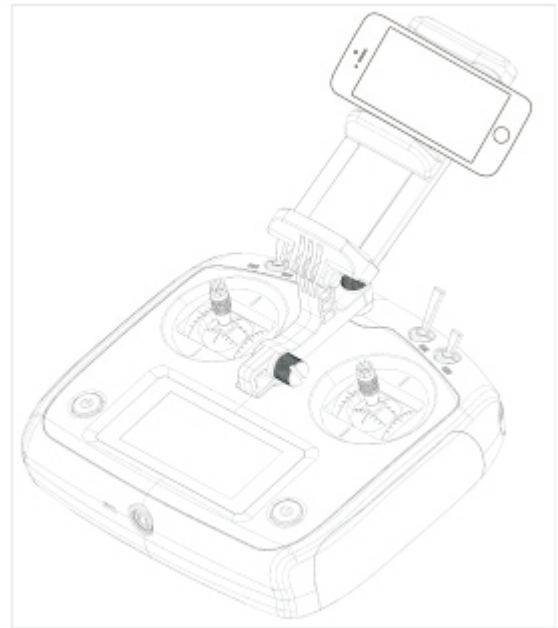

5. Tighten the lock screw on the back of the bracket.

# Digital Proportional Radio Control System FS-i6S

If you are using a mobile device with a large screen follow the steps below:

1

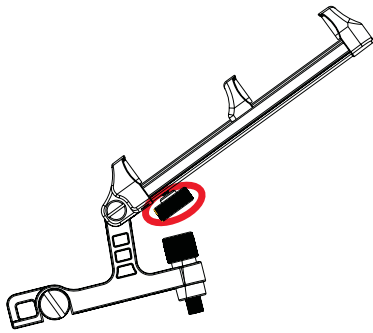

1. Loosen the locking screw by turning it anti-clockwise.

2

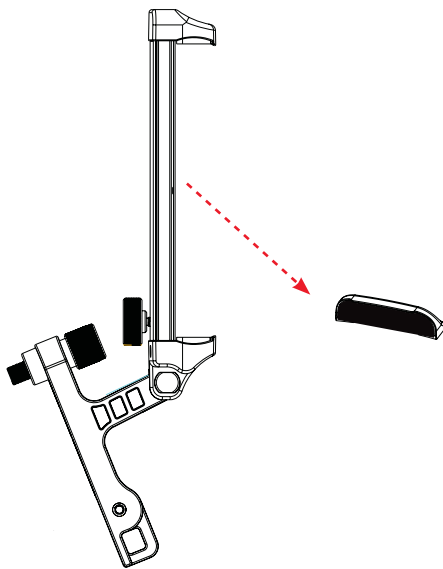
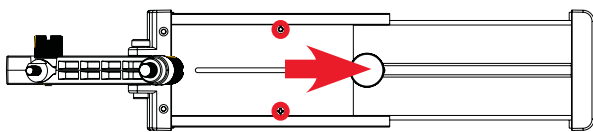

2. Move the slide to the highest position and remove the screws marked in red.

3

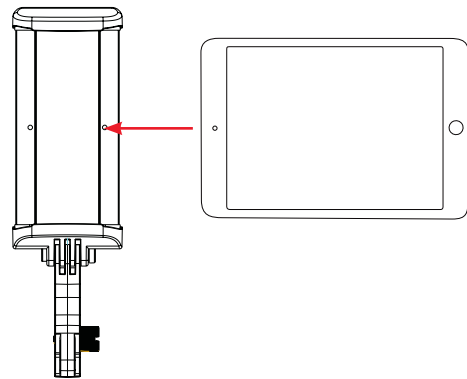

3. Move your device into the centre of the bracket. Be careful not to let the device fall.

4

4. Attached the bracket to the transmitter. Make sure that the notch at the front of the bracket fits over the eye located on the centre of the transmitter and that the locking screws are secure.

5

5. Adjust the slider so that it grips the device firmly, and tighten the locking screw on the back of the bracket.



## 9. Product Specifications

This section contains the FS-i6S transmitter and FS-X6B receiver specifications.

### 9.1 Transmitter specification(FS-i6S)



Channels	6
Model type	Quadcopter
RF range	2.4055 - 2.475 GHz
Bandwidth	500 KHz
RF channel	140
RF power	Less than 20 dBm
2.4GHz system	AFHDS 2A
Modulation type	GFSK
Stick resolution	4096
Low voltage alarm	Yes (lower than 4.2V)
PS2/USB Port	Yes
Power input	4.2V - 6.0V
Weight	410g
Size (Length x Width x Height)	179mm x 81mmx 161mm
Color	White,Black
Certificate	CE0678, FCC ID : N4ZFLYSKYI6S

### 9.2 Receiver Specification( FS-X6B )

Channels	Single channel S.BUS Mode , 10 channels ; Single PPM mode , 8 channels ; PWM receiver mode , 6 channels
Model type	Quadcopter/Helicopter/Fixed-wing
RF range	2.4055-2.475 GHz
RF channel	140
RX sensitivity	-105dBm
2.4GHz system	AFHDS 2A
Modulation type	GFSK
Power input	4.5 - 6.5 V DC
Weight	59
Antenna length	100 mm*2
Size (Length x Width x Height)	36mm×22mm×8mm
Color	Blue
Certificate	CE0678, FCC ID : N4ZFLYSKYIA6B
i-BUS port	Yes
Independent port	Yes
PPM common port	Yes
Data acquisition port	Yes

# Digital Proportional Radio Control System **FS-i6S**

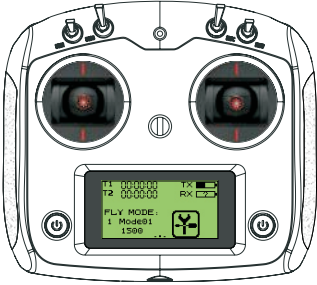
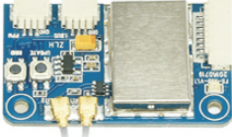
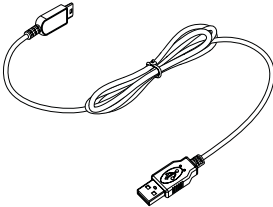
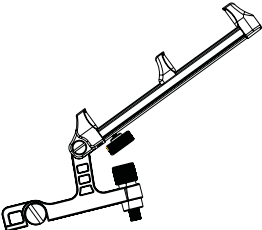
## 10. Package Contents

Product	Quantity	
FS-i6S transmitter	1	
FS-X6B receiver	1	
Micro USB Cable	1	
Mobile Phone Holder	Optional	
User manual (CD)	1	

## Appendix 1 FCC Statement

This equipment has been tested and found to comply with the limits for a Class B digital device pursuant to part 15 of the FCC rules. These limits are designed to provide reasonable protection against harmful interference in a residential installation. This equipment generates, uses and can radiate radio frequency energy and, if not installed and used in accordance with the instructions, may cause harmful interference to radio communications. However, there is no guarantee that interference will not occur in a particular installation. If this equipment does cause harmful interference to radio or television reception, which can be determined by turning the equipment off and on, the user is encouraged to try to correct the interference by one or more of the following measures:

- Reorient or relocate the receiving antenna.
- Increase the separation between the equipment and receiver.
- Connect the equipment into an outlet on a circuit different from that to which the receiver is connected.
- Consult the dealer or an experienced radio/TV technician for help.

To assure continued compliance, any changes or modifications not expressly approved by the party responsible for compliance could void the user's authority to operate this equipment. (Example use only shielded interface cables when connecting to computer or peripheral devices).

This equipment complies with Part 15 of the FCC Rules. Operation is subject to the following two conditions:

- (1) This device may not cause harmful interference, and
- (2) This device must accept any interference received, including interference that may cause undesired operation.

### Caution!

The manufacturer is not responsible for any radio or TV interference caused by unauthorized modifications to this equipment. Such modifications could void the user authority to operate the equipment.

1. Move all your channels to the desired position.
2. Select [**All channels**] and then [**Yes**] in the confirmation box.

# Digital Proportional Radio Control System **FS-i6S**



<http://www.flysky-cn.com>

Copyright ©2015-2016 Flysky RC model technology co., Ltd  
Edition: 2016-10-1



**CE 0678**  
FCC ID: N4ZFLYSKYI6S