



ShenZhen Top Create Electronic Co ., Ltd

Website: www.szccge.cn.alibaba.com

Tel: +86-755-25937185-85

CJ - CAM User Manual

OV528 Protocol

OV528 PROTOCOL

Serial Interface

Single-byte Timing Diagram

RS232 single-byte transmission consists of the start bit, 8 data bits and the stop bit. Start bit is fixed at 0, stop bit is fixed at 1. LSB is sent out first and is right after the start bit. Please check the chart below.

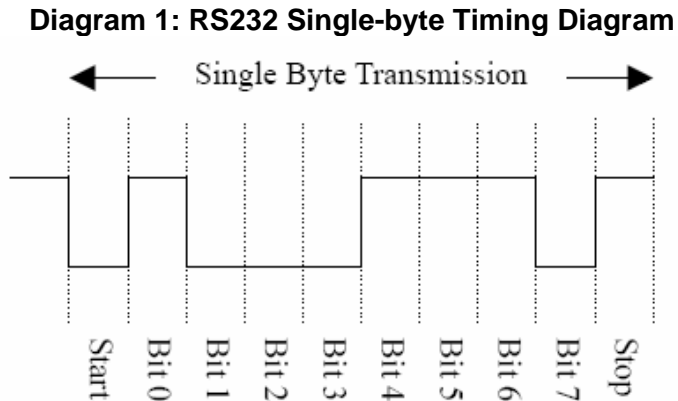

Command Timing Diagram

One single command consists of 6 continuous single-bytes. Please find the example of SYNC (AA0D00000000h) command.

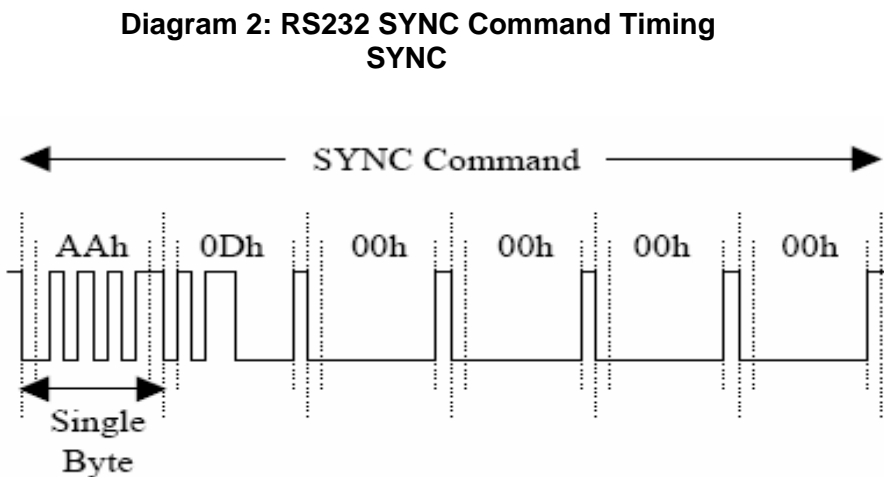

Command Set

Camera can support 11 commands for interfacing to host as following.

No.	Command	Command ID	Parameter 1	Parameter 2	Parameter 3	Parameter 4
1	Initial	AA01h	00h	Color Setting	Preview Resolution	JPEG Resolution
2	Get Picture	AA04h	Get Setting	00h	00h	00h
3	Snapshot	AA05h	Snapshot Setting	Skip Frame (low byte)	Skip Frame (high byte)	00h
4	Set Package Size	AA06h	08h	Package Size (low byte)	Package Size (high byte)	00h
5	Set Baud-rate	AA07h	1 st Divider	2 nd Divider	00h	00h
6	Reset	AA08h	Reset Setting	00h	00h	xxh
7	Power Down	AA09h	00h	00h	00h	00h
8	Data	AA0Ah	Date Type	Length-byte 0	Length-byte 1	Length-byte 2
9	SNYC	AA0Dh	00h	00h	00h	00h
10	ACK	AA0Eh	Command ID	ACK counter	Package ID Byte 0	Package ID Byte 1
11	NAK	AA0Fh	00h	NAK counter	Error Number	00h

* If the parameter is FFh, firmware will respond immediately.

Interface Commands Details

1. Initial (AA01h)

The host issues this command to configure the preview image size and color type. After receiving this command, the camera will send out an ACK command to the host if the configuration success. Otherwise, an NACK command will be sent out.

Color Setting	
2-bit Gray-Scale	01h
4-bit Gray- Scale	02h
8-bit Gray- Scale	03h
2-bit Color	05h
16-bit Color	06h
JPEG	07h

Preview Resolution	
80*60	01h
160*120	03h

JPEG Resolution

80*64	01h
160*128	03h
320*240	05h
640*480	07h

2. Get Picture (AA04h)

Host issues this command to get a picture from camera.

Get Setting	
Snapshot	01h
Preview Picture	02h
JPEG Preview Picture	03h

3. Snapshot (AA05h)

Camera keeps a single frame of JPEG still picture data in the buffer after receiving this command..

Snapshot Setting	
Compressed Picture	00h
Uncompressed Picture	01h

Skip Frame: the number of dropped frames can be defined before compression occurs. "0" keeps the current frame, "1" captures the next frame ect.

4. Set Package Size (AA06h)

Host will send out the size of JPEG still picture after receiving this command issued by camera. Type of package is as follows:

ID (2 byte)	Date Size (2 byte)	Image Data (Package Size-6 byte)	Verify Code (2 byte)
----------------	-----------------------	-------------------------------------	-------------------------

ID: Package ID, stars from zero for an image

Data Size: Size of image data in this package

Verify Code: Error detection code, equals to the lower byte of sum of the whole package data except the verify code field. The higher byte of this code is always zero. i.e. verify code=low byte(sum(byte **【0】** to byte **【N-2】**)

Note: As the transmission of uncompressed image is not the package mode, it is not necessary to set the package size for the uncompressed image.

5. Set Baud Rate (AA07h)

Host issues this command to set camera's baud rate. Camera auto-detects the baud rate issued by host and keep the baud rate to communicate with host, reconfiguration should be made if power off. The baud rates were supported by camera as follows.

$$\text{Baud Rate} = 14.7456\text{MHz} / 2 * (2^{\text{nd}} \text{ divider} + 1) / 2 * (1^{\text{st}} \text{ divider} + 1)$$

Baud Rate	1 st Divider	2 nd Divider	Baud Rate	1 st Divider	2 nd Divider
7200bps	FFh	01h	28800bps	3Fh	01h
9600bps	BFh	01h	38400bps	2Fh	01h
14400bps	7Fh	01h	57600bps	1Fh	01h
19200bps	5Fh	01h	115200bps	0h	01h

6. Reset (AA08h)

Reset Setting	
00h	Reset the whole system, Camera will reboot and reset all registers and state machine
01h	Reset state machine only

7. Power down (AA09h)

Camera will go into sleep mode after receiving this command and get resumed after sending out an ACK against SYNC command issued by host.

8. Data (AA0Ah)

The type and size of image data prepared for transmitting out to host would be advised to host when camera issuing this command.

Data Type	
Snapshot Picture	01h
Preview Picture	02h
JPEG Picture	05h

Data Length: these 3 bytes represent the length of Snapshot Picture, Preview Picture and JPEG Preview Picture.

9. SYNC (AA0Dh)

Either the host or the camera can issue this command to make connection. An ACK command must be sent out after receiving this command.

10. ACK (AA0Eh)

This command indicates the success of the last operation. After receiving any valid command, ACK command must be sent out except when getting preview data. The host can issue this command request image data package with desired package ID after receiving Data command from camera, and send this command with package ID 0F0Fh when finishing with receiving data package.

Note: "Command ID" is 00h when host requesting image data package.

Command ID: The command with that ID is acknowledged by this command.

ACK Counter: Not in use

Package ID: For acknowledging Data Command, these two bytes represent the requested package ID. While for acknowledging other commands, these two bytes are set to 00h.

11. NAK (AA0Fh)

This command shows corrupted transmission or unsupported features.

NAK Counter: Not in use

Error Number: (Please read the following chart)

Error Messages	NAK code	Error Messages	NAK code
Picture Type Error	01h	Parameter Error	0Bh
Picture Up Scale	02h	Send Register Timeout	0Ch
Picture Scale Error	03h	Command ID Error	0Dh
Unexpected Respond	04h	Picture Not Ready	0Fh
Send Picture Timeout	05h	Transfer Package Number Error	10h
Unexpected Command	06h	Set Transfer Package Size Wrong	11h
ASRAM JPEG Type Error	07h	Command Header Error	F0h
ASRAM JPEG Size Error	08h	Command Length Error	F1h
Picture Format Error	09h	Send Picture Error	F5h
Picture Size Error	0Ah	Send Command Error	FFh

Command Protocol

1. SYNC Command

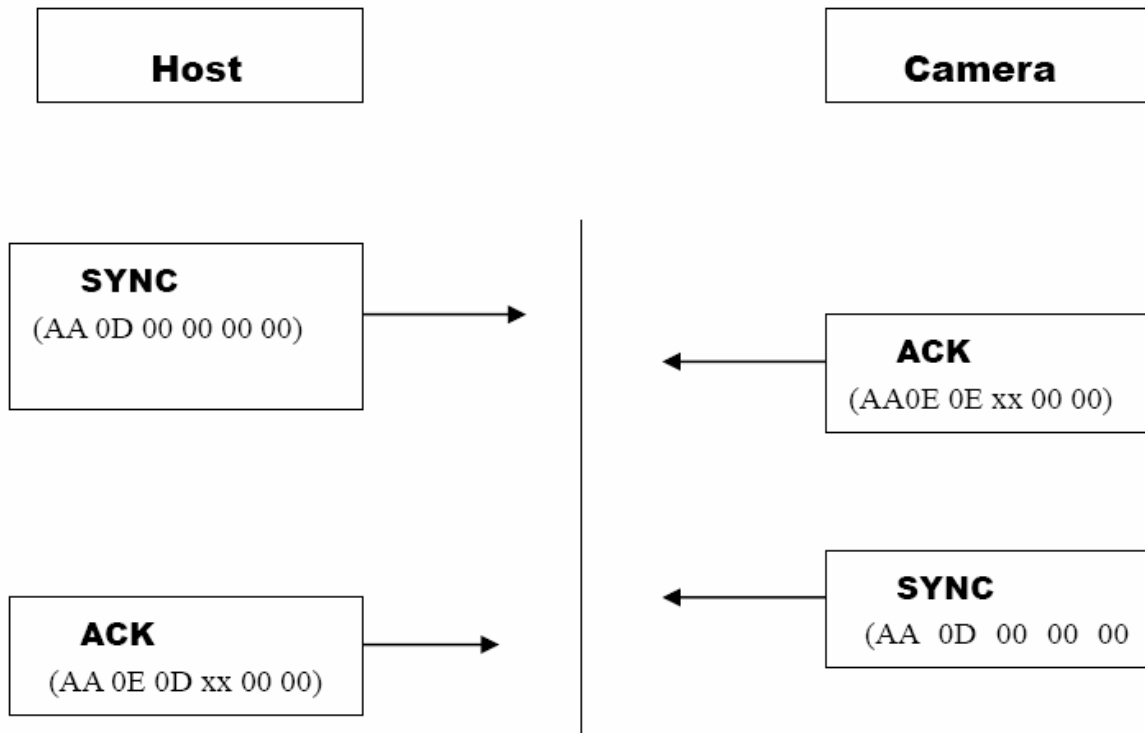

2. Make connection with camera

Host issues SYNC (baud rate: 9600bps) to await ACK from camera (usually an ACK command is received after sending 25 times of SYNC command). .

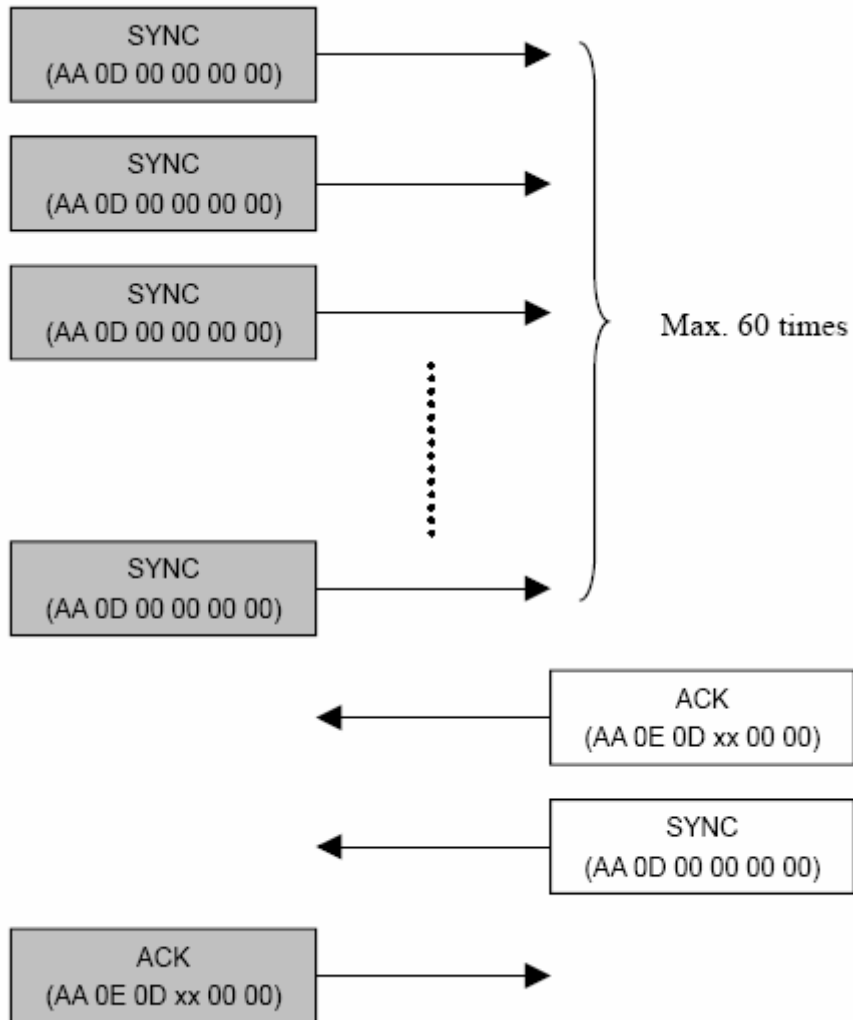

Note: SYNC commands are 60 times at most.

3. Initial/ Get Picture/ Snapshot/Set Baud Rate / Reset/ Power down Command

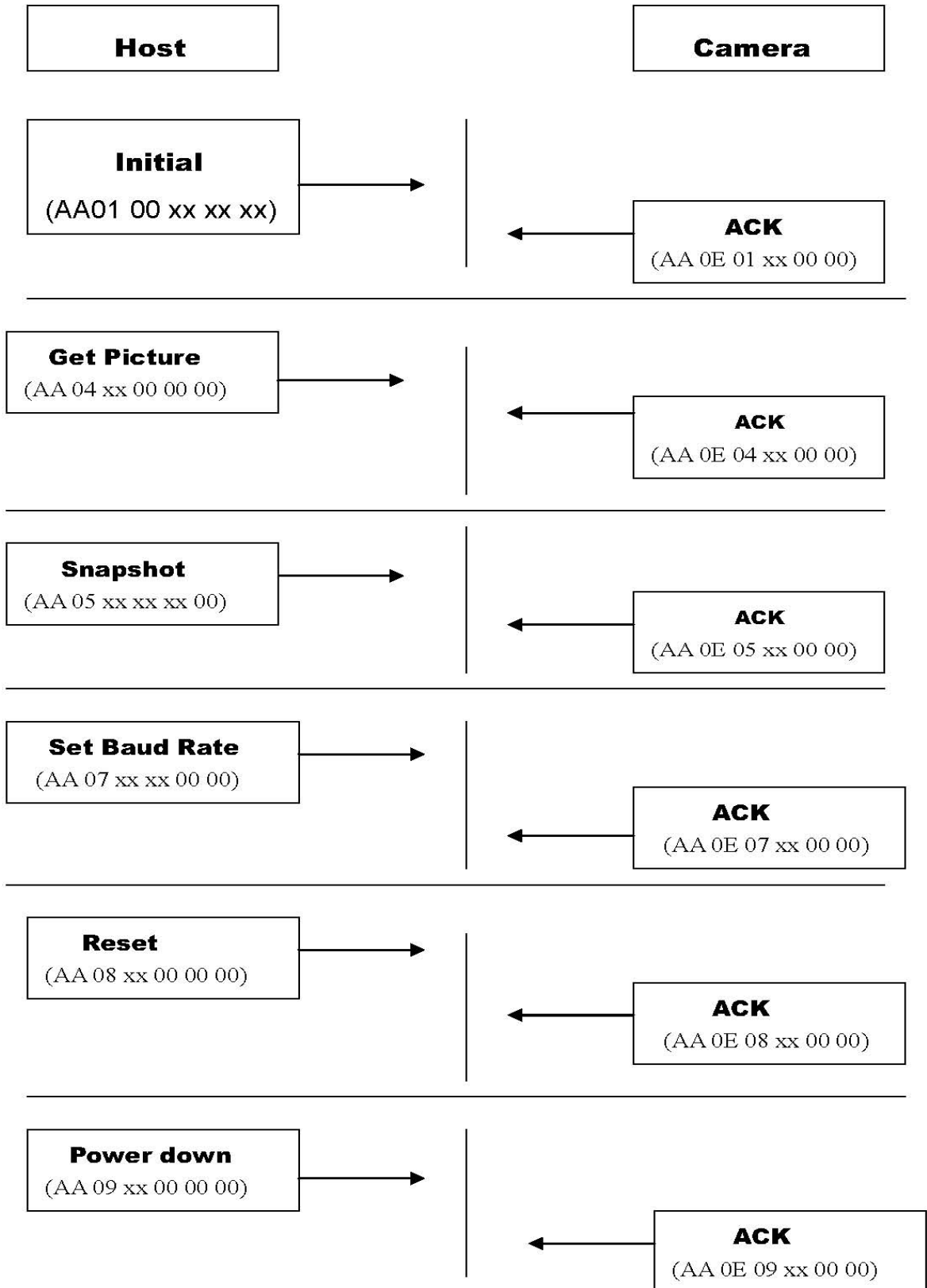

4. Getting a Snapshot through RS232

Please make assure that connection is already made before the following communication.

4.1 JPEG Snapshot Picture

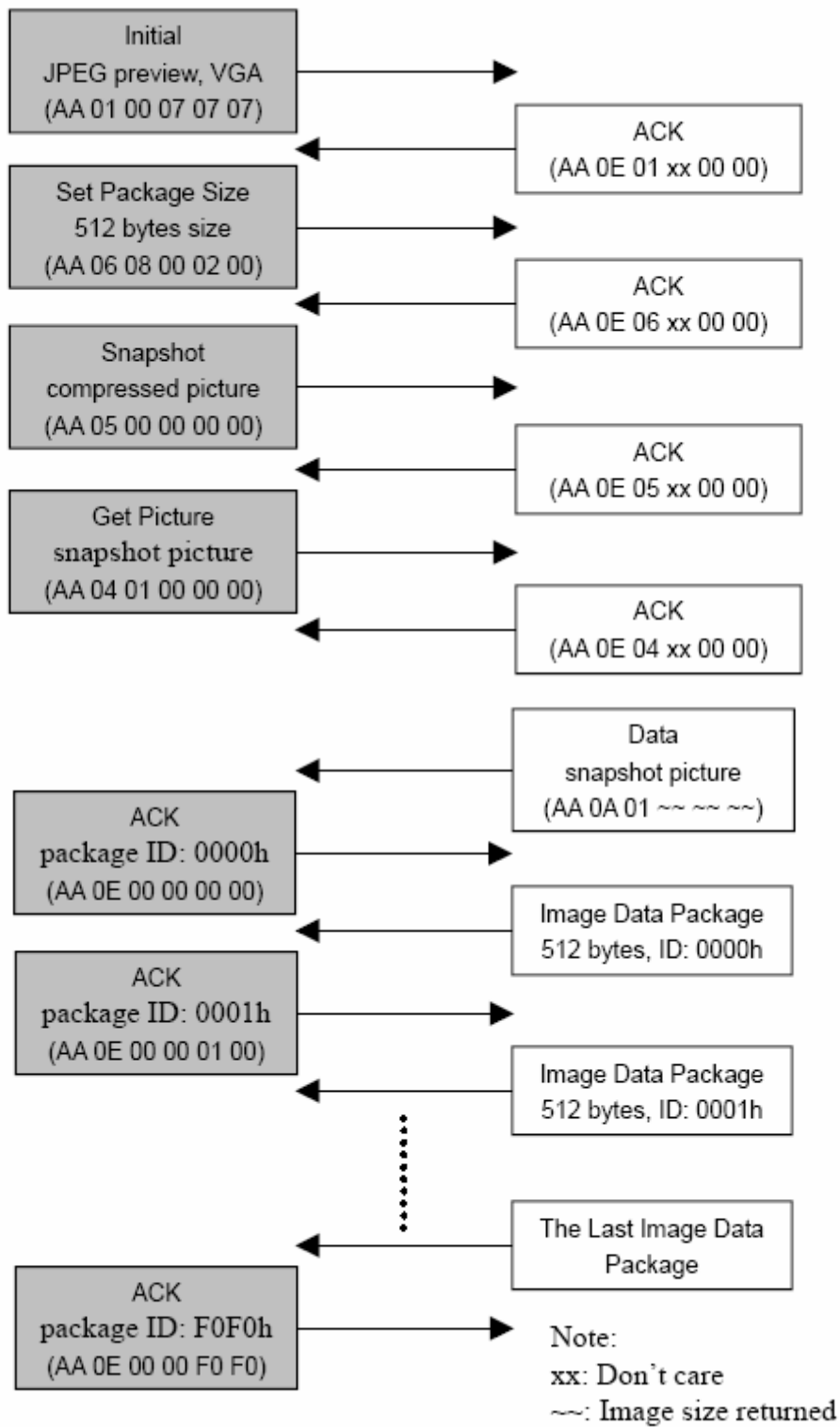

Remark: 1) "xx" any number;
2) "~~" image size returned.

4.2 Uncompressed Snapshot Picture)

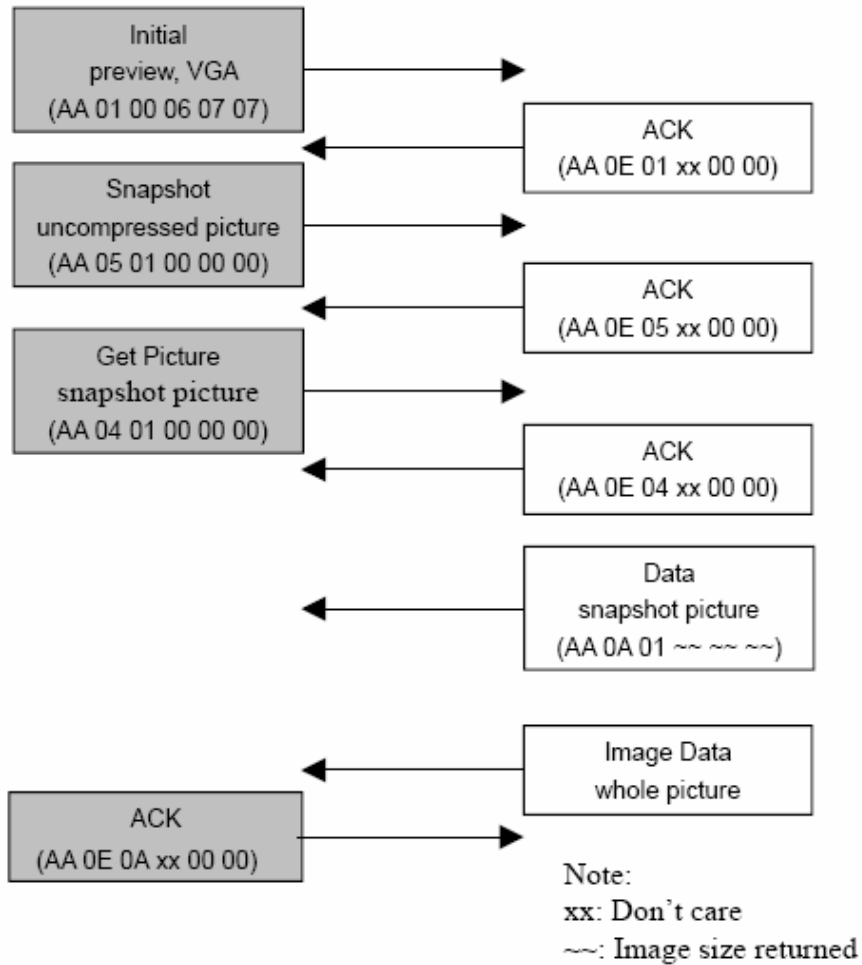

Remark: 1) "xx" any number;
2) "~~" image size returned.

5. Getting a preview Picture through RS232

Please make assure that connection is already made before the following communication.

5.1 JPEG Preview Picture

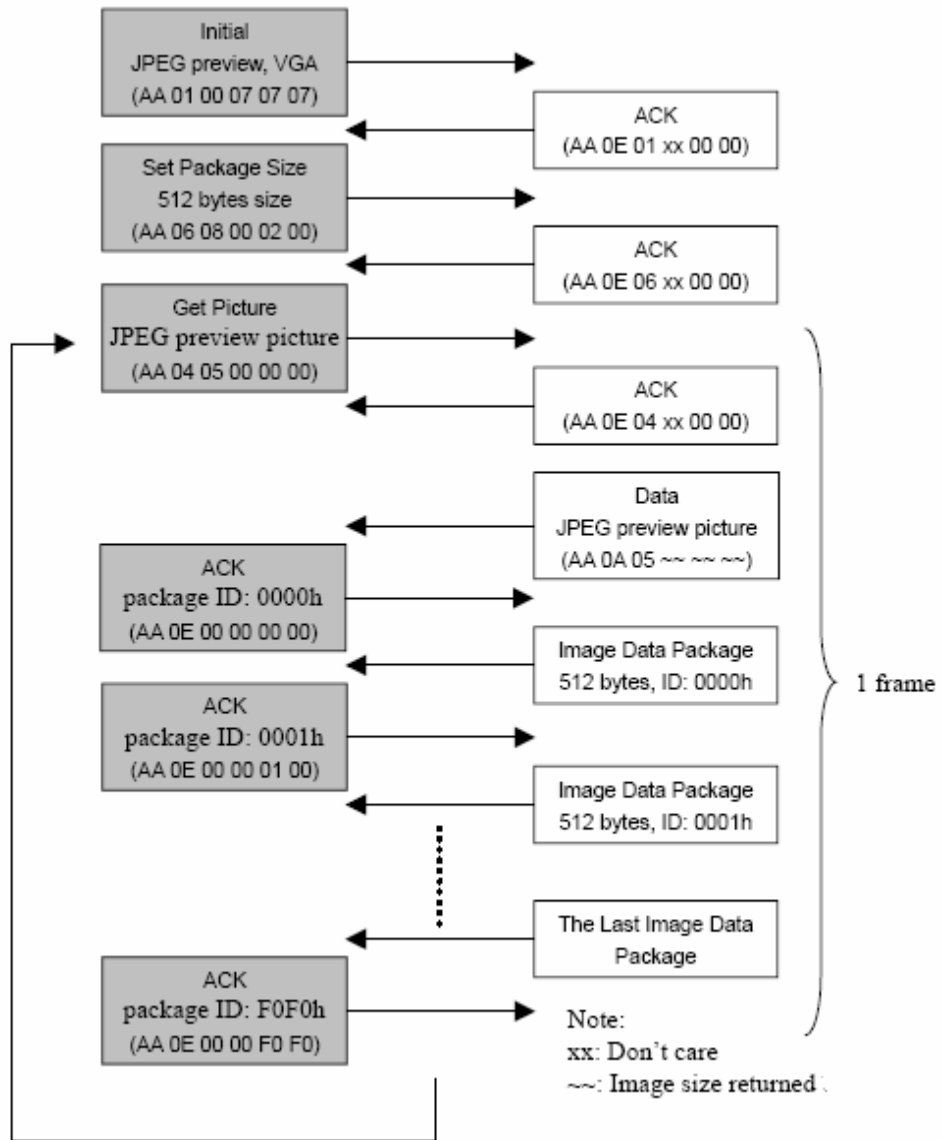

Remark: 1) "xx" any number;
2) "~~" : image size returned

5.2. Preview un-impressed image

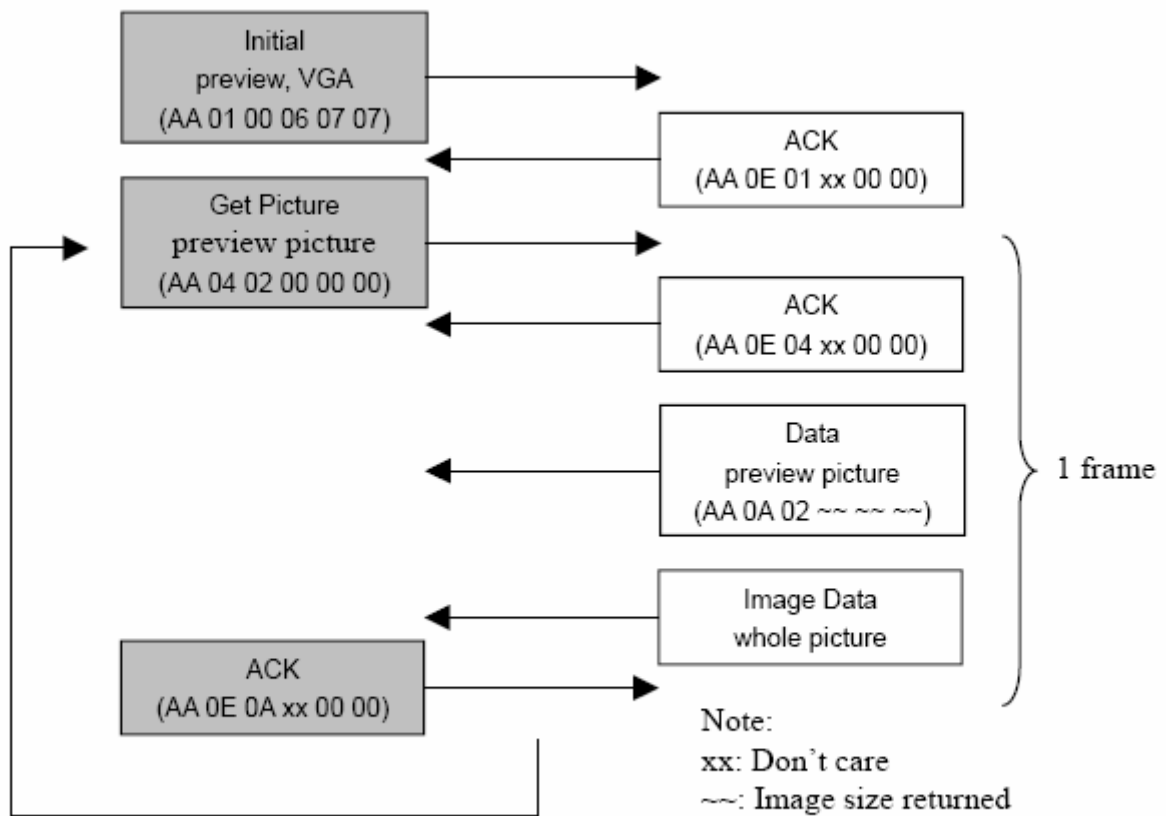

Remark: 1) "xx" any number;
2) "~~" image size returned.