



# USB TO RS232/485/TTL

## User Manual

### Overview

This is an industrial USB to RS232/485/TTL isolated converter with original FT232RL inside. It features embedded protection circuits such as power isolation, ADI magnetical isolation, and TVS diode, etc. What's more, the USB TO RS232/485/TTL comes with an aluminium alloy enclosure, make it solid and durable to work.

The USB TO RS232/485/TTL is very easy to use, fully automatic transeiving without delay. Due to its fast communication, stability, reliability, and safety, it is an ideal choice for industrial control equipments and/or applications with high communication requirement.

### Features

- USB TO RS232, USB TO RS485, USB TO TTL (UART)
- Adopt original FT232RL, fast communicating, stable and reliable, better compatibility
- Onboard unibody power supply isolation, provides stable isolated voltage, needs no extra power supply for the isolated terminal
- Onboard unibody magnetical isolation, allows signal isolation, high reliability, strong anti-interference, low power consumption

- Onboard TVS (Transient Voltage Suppressor), effectively suppress surge voltage and transient spike voltage in the circuit, lightning-proof & anti-electrostatic
- Onboard self-recovery fuse and protection diodes, ensures the current/voltage stable outputs, provides over-current/over-voltage proof, improves shock resistance
- Fully automatic transceiver circuit with no delay, ensures the USB port communicates with different interfaces fastly and stably, without interfering each other
- Onboard TTL serial 3.3V/5V voltage translator, config the TTL level via switch
- Aluminium alloy enclosure with sand blasting and anodic oxidation, CNC process opening, solid and durable
- 3 LEDs for indicating the power and transceiver status
- High quality USB-B and RS232 connectors, smoothly plug/pul

## Specifications

- Product type: industrial ADI magnetical isolation converter
- Baudrate: 300-921600bps
- Host port: USB
- Device port: RS485/RS232/TTL
- USB:
  - Operating voltage: 5V
  - Connector: USB-B
  - Protection: 200mA self-recovery fuse, isolated output

- Transmission distance: ~5m
- RS485:
  - Connector: screw terminal
  - Pins: A+, B-, GND
  - Direction control: hardware automatic control
  - Protection: 600W lightning-proof and surge-suppress, 15KV ESD protection  
(reserved 120R balancing resistor solder pads)
  - Transmission distance: ~1200m
  - Transmission mode: point-to-multipoints (up to 32 nodes, it is recommended to use repeaters for 16 nodes or more)
- RS232:
  - Connector: DR9 male
  - Protection: TVS diode, surge protection, ESD protection
  - Transmission distance: ~15m
  - Transmission mode: point-to-point
- TTL (UART):
  - Operating voltage: 3.3V/5V
  - Connector: screw terminal
  - Pins: TXD, RXD, GND
  - Protection: clamp protection diode, over-voltage/negative-voltage proof,  
shock resistance
  - Transmission mode: point-to-point

- LED indicators:
  - PWR: red power indicator, light up when there is USB connection and voltage is detected
  - TXD: green TX indicator, light up when the USB port sends data
  - RXD: blue RX indicator, light up when the device ports send data back
- Operating environment:
  - Temperature: -15°C ~ 70°C
  - Humidity: 5%RH ~ 95%RH
- Operating system: Windows 10 / 8.1 / 8 / 7 / XP

**Note:** There is a pad reserved for 120R balancing resistance. Recommend you to weld 120Ω resistors to the first and last devices if you connect many devices at the same time.

## CONECTENT

Overview.....	1
Features.....	1
Specifications.....	2
Driver Installation.....	6
Testing.....	10
Interfaces.....	10
RS232.....	10
RS485.....	11
TTL.....	12

## Driver Installation

1. Connect module to PC, if you find that a yellow exclamation symbol occur as below, driver is required.

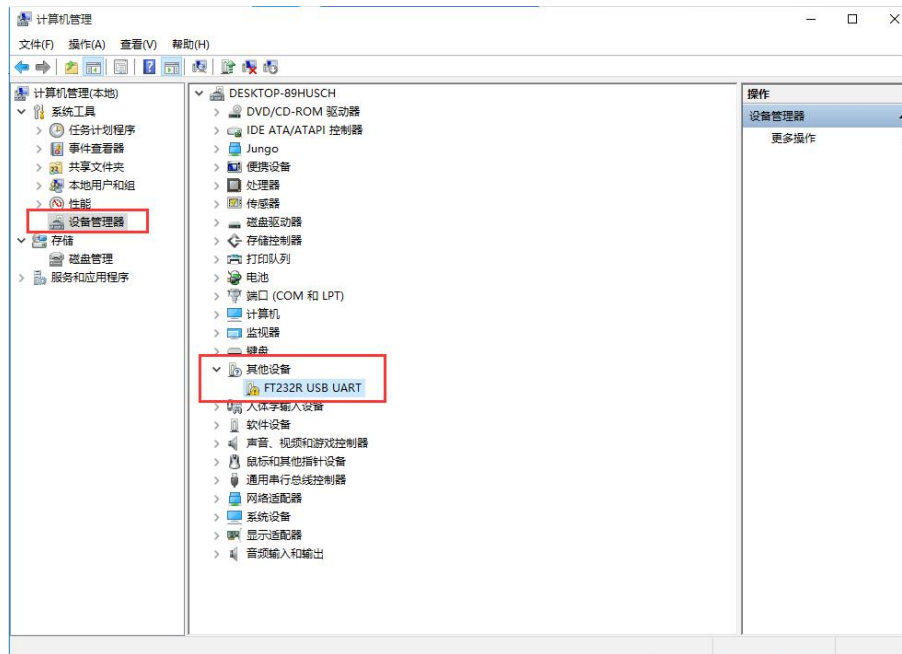

2. Download the driver from Waveshare Wiki

[https://www.waveshare.com/wiki/USB\\_TO\\_RS232/485/TTL#Resources](https://www.waveshare.com/wiki/USB_TO_RS232/485/TTL#Resources)

3. After downloading, extract and install it

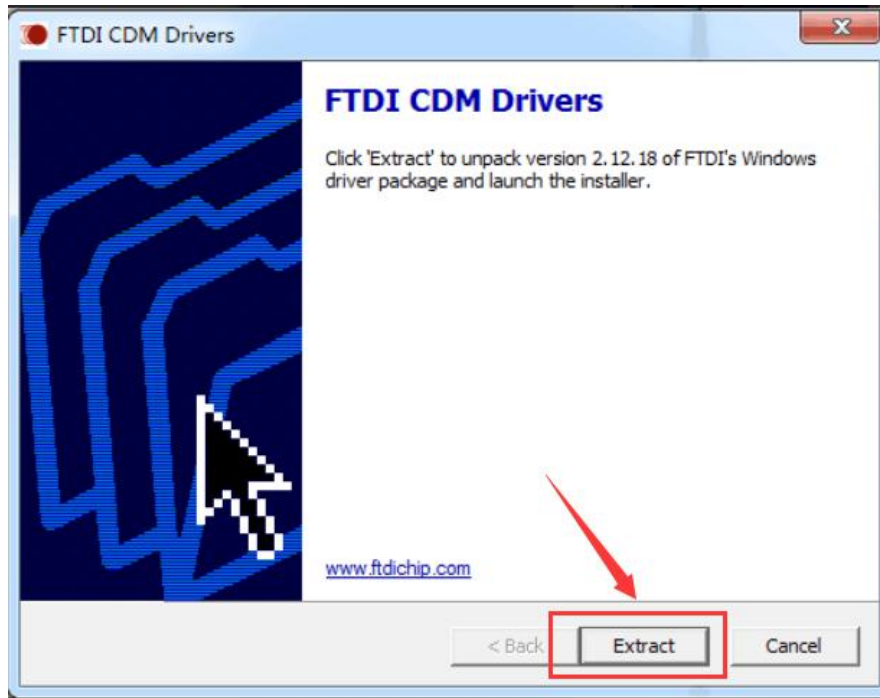

4. Click Extract:

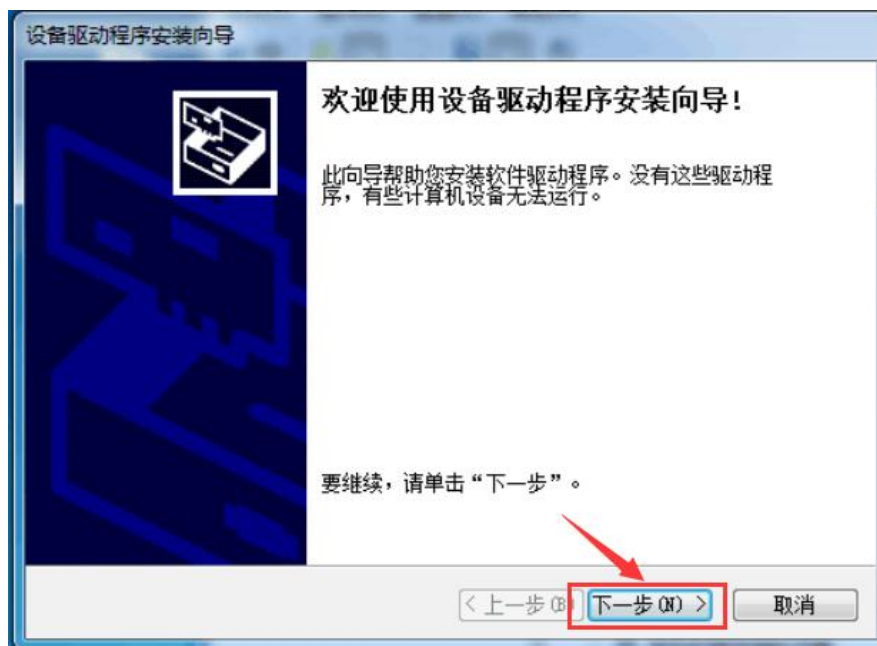

5. Click Next Step:

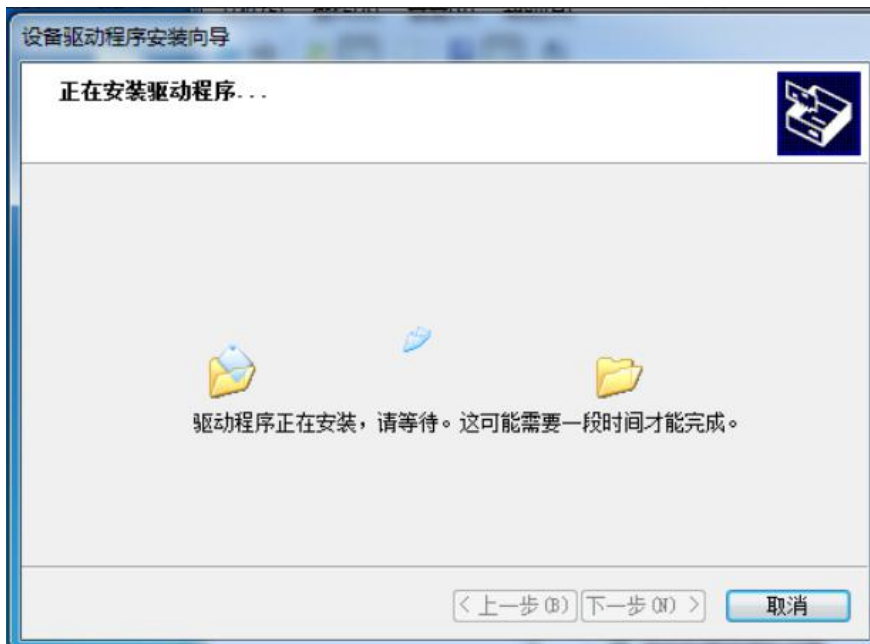
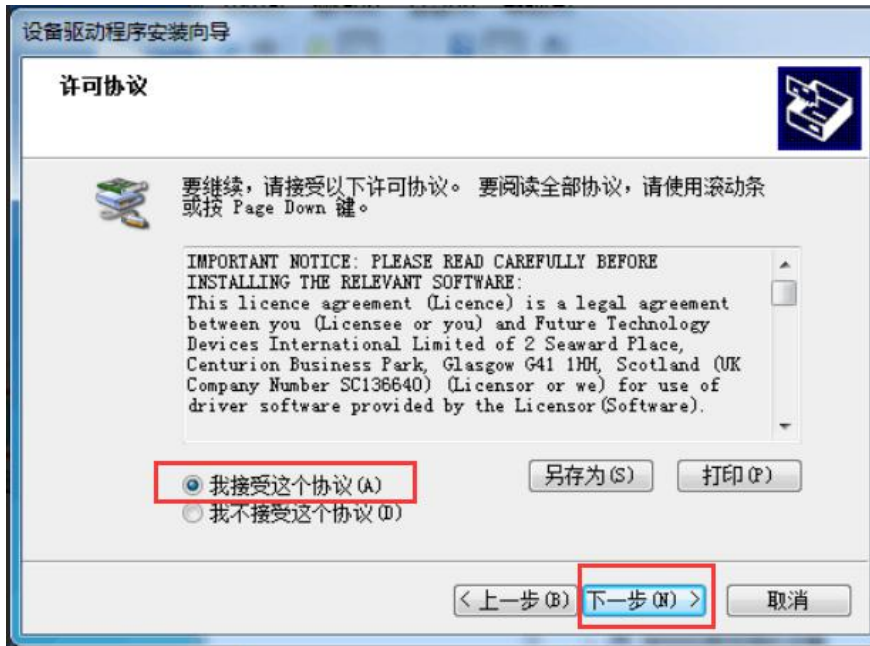



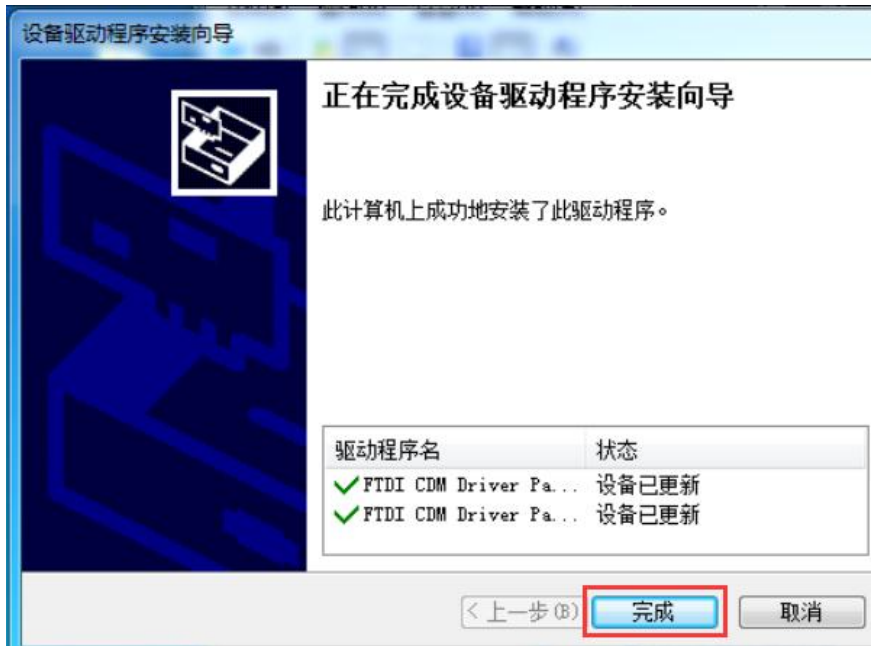

6. After installing, you can check if the yellow exclamation symbol disappear.

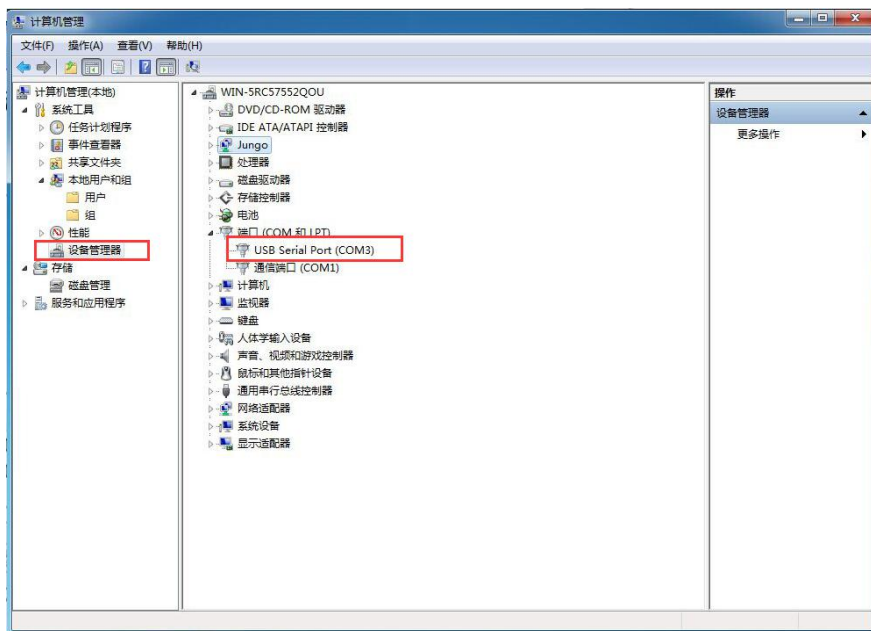

# Testing

## INTERFACES

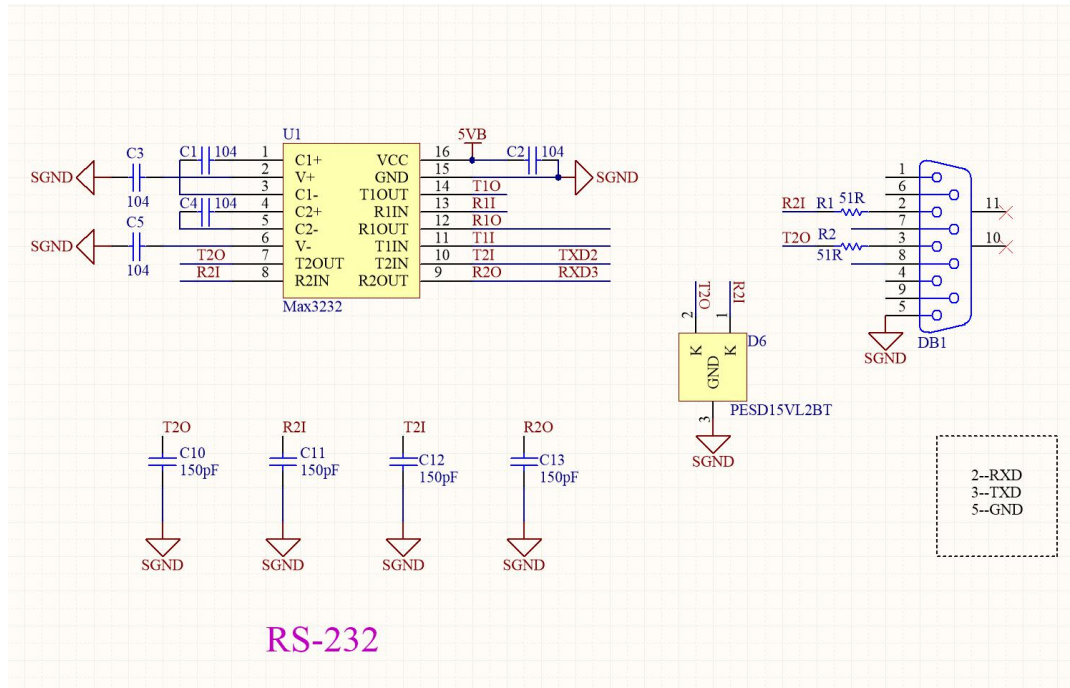

## RS232

Connect RS232 and USB interface to PC. Open two Serial Assistance Software and set them with same baudrate, test them as below:



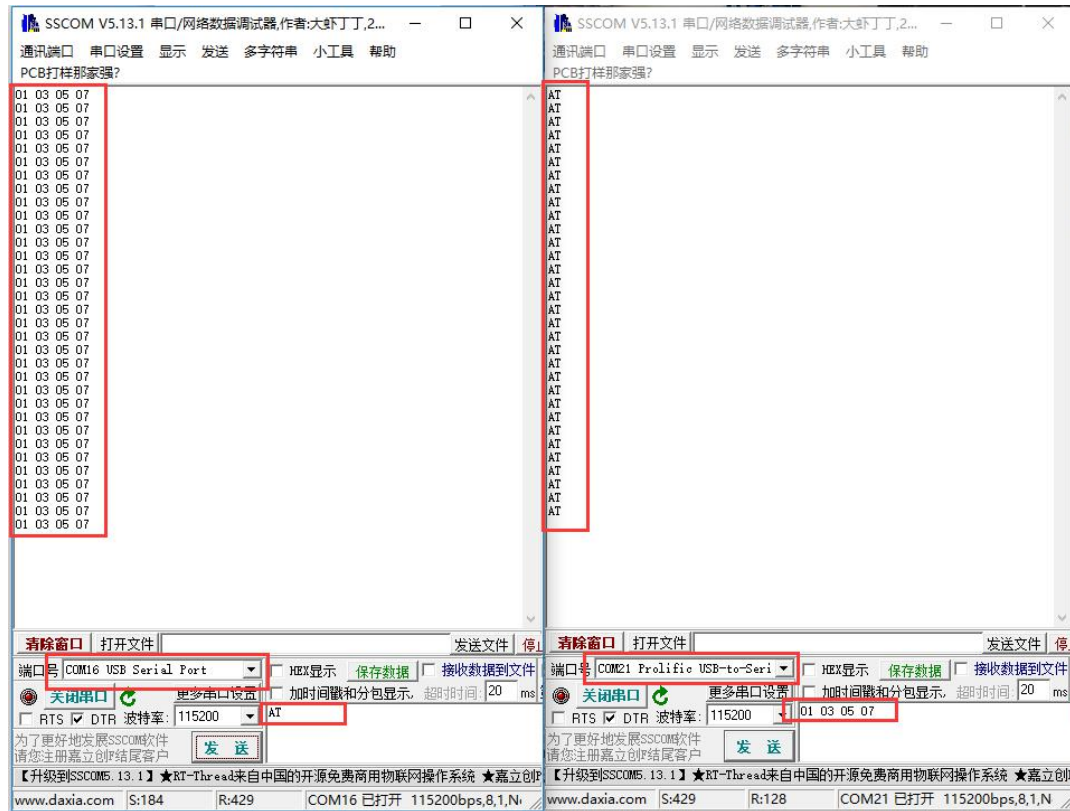

## RS485

Connect RS485 interface to RS485 interface of target board (here we use our RS485 board to test), A to A and B to B. Open two Serial Software on PC and test it. (Note that RS485 Board should pull-high RSE to send data and pull0download it to receive) )

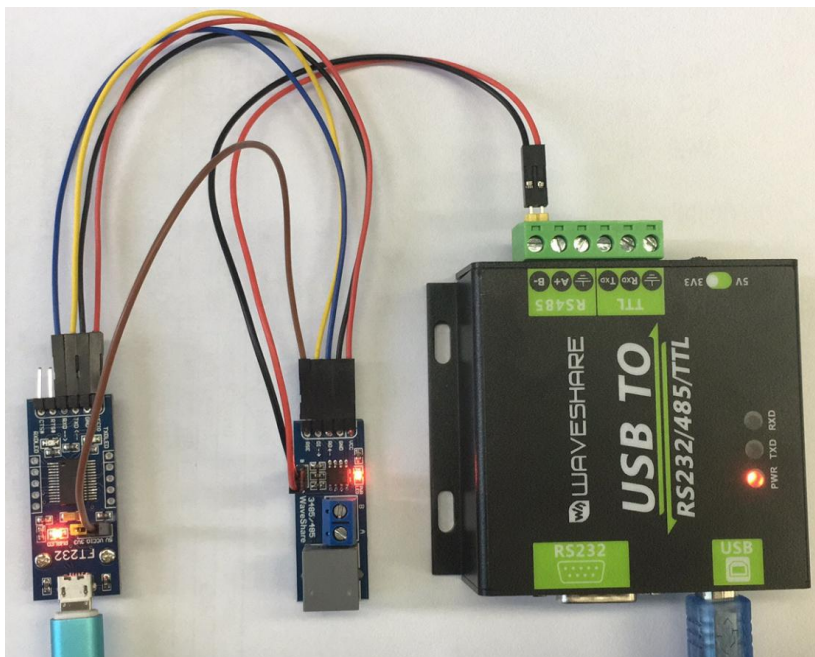

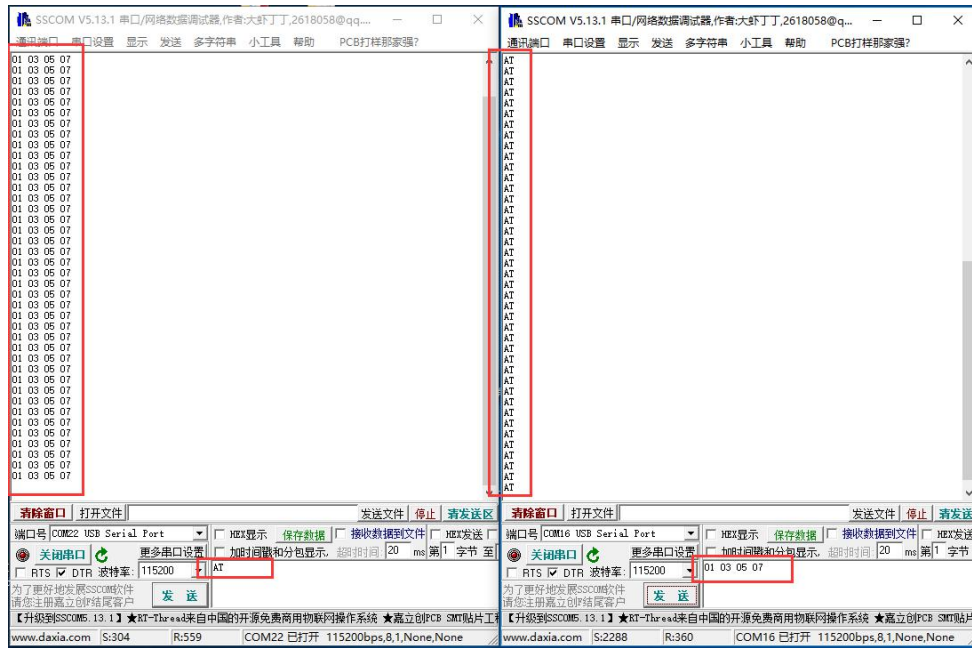

## TTL

Connect TTL interface to other UART board and connect to PC, open two Serial software and test:

