



Adafruit Feather 32u4 Bluefruit LE

Created by lady ada



<https://learn.adafruit.com/adafruit-feather-32u4-bluefruit-le>

Last updated on 2022-09-05 08:54:04 PM EDT

Table of Contents

Overview	7
Pinouts	12
<ul style="list-style-type: none">• Power Pins• Logic pins• Bluefruit LE Module + Indicator LEDs• Other Pins!• Top Side• Bottom Side	
Assembly	16
<ul style="list-style-type: none">• Header Options!• Soldering in Plain Headers• Prepare the header strip:• Add the breakout board:• And Solder!• Soldering on Female Header• Tape In Place• Flip & Tack Solder• And Solder!	
Power Management	25
<ul style="list-style-type: none">• Battery + USB Power• Power Supplies• Measuring Battery• ENable pin• Alternative Power Options	
Arduino IDE Setup	29
Using with Arduino IDE	32
<ul style="list-style-type: none">• Install Drivers (Windows 7 Only)• Blink• Manually bootloading• Ubuntu & Linux Issue Fix	
Installing BLE Library	37
<ul style="list-style-type: none">• Install the Adafruit nRF51 BLE Library• Run first example• Uploading to the Feather Bluefruit LE• Uploading to a brand new board/Upload failures• Run the sketch• AT command testing	
Configuration!	45
<ul style="list-style-type: none">• Which board do you have?• Bluefruit Micro or Feather 32u4 Bluefruit• Feather M0 Bluefruit LE• Bluefruit LE SPI Friend• Bluefruit LE UART Friend or Flora BLE• Configure the Pins Used	

- Common settings:
- Software UART
- Hardware UART
- Mode Pin
- SPI Pins
- Software SPI Pins
- Select the Serial Bus
- UART Based Boards (Bluefruit LE UART Friend & Flora BLE)
- SPI Based Boards (Bluefruit LE SPI Friend)

BLEUart 51

- Opening the Sketch
- Configuration
- Running the Sketch

HIDKeyboard 56

- Opening the Sketch
- Configuration
- Running the Sketch
- Bonding the HID Keyboard
- Android
- iOS
- OS X

Controller 64

- Opening the Sketch
- Configuration
- Running the Sketch
- Using Bluefruit LE Connect in Controller Mode
- Streaming Sensor Data
- Control Pad Module
- Color Picker Module

HeartRateMonitor 71

- Opening the Sketch
- Configuration
- If Using Hardware or Software UART
- Running the Sketch
- nRF Toolbox HRM Example
- CoreBluetooth HRM Example

UriBeacon 76

- Opening the Sketch
- Configuration
- Running the Sketch

HALP! 78

AT Commands 80

- Test Command Mode '='
- Write Command Mode '=xxx'
- Execute Mode
- Read Command Mode '?'

Standard AT	82
<ul style="list-style-type: none"> • AT • ATI • ATZ • ATE • +++ 	
General Purpose	85
<ul style="list-style-type: none"> • AT+FACTORYRESET • AT+DFU • AT+HELP • AT+NVMWRITE • AT+NVMREAD • AT+MODESWITCHEN 	
Hardware	89
<ul style="list-style-type: none"> • AT+BAUDRATE • AT+HWADC • AT+HWGETDIETEMP • AT+HWGPIO • AT+HWGPIOMODE • AT+HWI2CSCAN • AT+HWVBAT • AT+HWRANDOM • AT+HWMODELED • AT+UARTFLOW 	
Beacon	95
<ul style="list-style-type: none"> • AT+BLEBEACON • AT+BLEURIBEACON • Deprecated: AT+EDDYSTONEENABLE • AT+EDDYSTONEURL • AT+EDDYSTONECONFIGEN • AT+EDDYSTONESERVICEEN • AT+EDDYSTONEBROADCAST 	
BLE Generic	102
<ul style="list-style-type: none"> • AT+BLEPOWERLEVEL • AT+BLEGETADDRTYPE • AT+BLEGETADDR • AT+BLEGETPEERADDR • AT+BLEGETRSSI 	
BLE Services	105
<ul style="list-style-type: none"> • AT+BLEUARTTX • AT+BLEUARTTXF • AT+BLEUARTRX • AT+BLEUARTFIFO • AT+BLEKEYBOARDEN • AT+BLEKEYBOARD • AT+BLEKEYBOARDCODE • Modifier Values • HID Keyboard Codes • AT+BLEHIDEN • AT+BLEHIDMOUSEMOVE 	

- AT+BLEHIDMOUSEBUTTON
- AT+BLEHIDCONTROLKEY
- AT+BLEHIDGAMEPADEN
- AT+BLEHIDGAMEPAD
- AT+BLEMIDIEN
- AT+BLEMIDIRX
- AT+BLEMIDITX
- AT+BLEBATTEN
- AT+BLEBATTVAL

BLE GAP 122

- AT+GAPCONNECTABLE
- AT+GAPGETCONN
- AT+GAPDISCONNECT
- AT+GAPDEVNAME
- AT+GAPDELBONDS
- AT+GAPINTERVALS
- AT+GAPSTARTADV
- AT+GAPSTOPADV
- AT+GAPSETADVDATA

BLE GATT 129

- GATT Limitations
- AT+GATTCLEAR
- AT+GATTADDSERVICE
- AT+GATTADDCHAR
- AT+GATTCHAR
- AT+GATTLIST
- AT+GATTCHARRAW

Debug 137

- AT+DBGMEMRD
- AT+DBGNVMRD
- AT+DBGSTACKSIZE
- AT+DBGSTACKDUMP

History 142

- Version 0.7.7
- Version 0.7.0
- Version 0.6.7
- Version 0.6.6
- Version 0.6.5
- Version 0.6.2
- Version 0.5.0
- Version 0.4.7
- Version 0.3.0

Command Examples 149

- Heart Rate Monitor Service
- Python Script

SDEP (SPI Data Transport) 152

- SDEP Overview
- SPI Setup
- SPI Hardware Requirements
- IRQ Pin

- [SDEP Packet and SPI Error Identifier](#)
- [Sample Transaction](#)
- [SDEP \(Simple Data Exchange Protocol\)](#)
- [Endianness](#)
- [Message Type Indicator](#)
- [SDEP Data Transactions](#)
- [Message Types](#)
- [Existing Commands](#)
- [SDEP AT Wrapper Usage](#)

[GATT Service Details](#) 163

- [UART Service](#)

[UART Service](#) 163

- [Characteristics](#)
- [TX \(0x0002\)](#)
- [RX \(0x0003\)](#)

[Software Resources](#) 164

- [Bluefruit LE Client Apps and Libraries](#)
- [Bluefruit LE Connect \(Android/Java\)](#)
- [Bluefruit LE Connect \(iOS/Swift\)](#)
- [Bluefruit LE Connect for OS X \(Swift\)](#)
- [Bluefruit LE Command Line Updater for OS X \(Swift\)](#)
- [Deprecated: Bluefruit Buddy \(OS X\)](#)
- [ABLE \(Cross Platform/Node+Electron\)](#)
- [Bluefruit LE Python Wrapper](#)
- [Debug Tools](#)
- [AdaLink \(Python\)](#)
- [Adafruit nRF51822 Flasher \(Python\)](#)

[BLE FAQ](#) 171

[DFU Bluefruit Updates](#) 182

[Downloads](#) 183

- [Schematic](#)
- [Fabrication Print](#)

[Device Recovery](#) 184

- [How to Recover a Bluefruit Board](#)
- [Still Having Problems?](#)

[Feather HELP!](#) 187

Overview

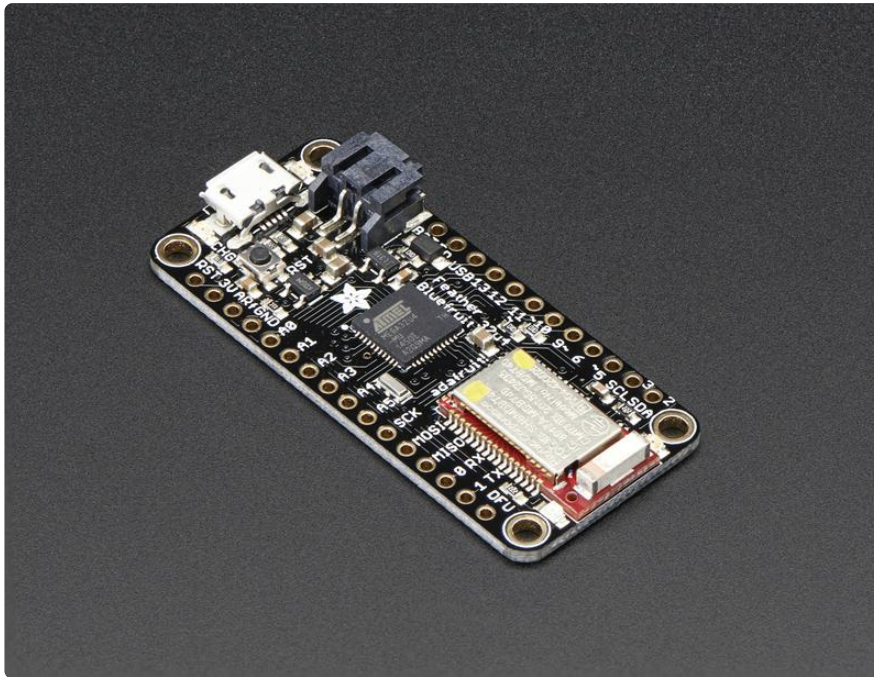

Feather is the new development board from Adafruit, and like its namesake it is thin, light, and lets you fly! We designed Feather to be a new standard for portable microcontroller cores.

This is the Adafruit Feather 32u4 Bluefruit - our take on an 'all-in-one' Arduino-compatible + Bluetooth Low Energy with built in USB and battery charging. Its an Adafruit Feather 32u4 with a BTLE module, ready to rock! [We have other boards in the Feather family, check'em out here \(https://adafru.it/jAQ\)](https://adafru.it/jAQ)

Bluetooth Low Energy is the hottest new low-power, 2.4GHz spectrum wireless protocol. In particular, its the only wireless protocol that you can use with iOS without needing special certification and it's supported by all modern smart phones. This makes it excellent for use in portable projects that will make use of an iOS or Android phone or tablet. It also is supported in Mac OS X and Windows 8+

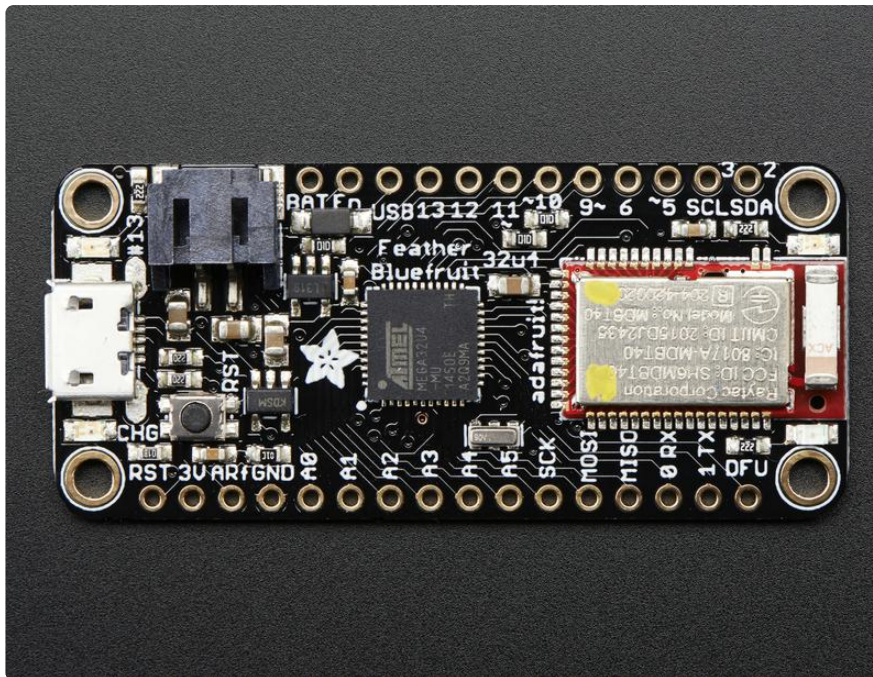

At the Feather 32u4's heart is an ATmega32u4 clocked at 8 MHz and at 3.3V logic, a chip setup we've had tons of experience with as [it's the same as the Flora \(https://adafruit.it/dVI\)](https://adafruit.it/dVI). This chip has 32K of flash and 2K of RAM, with built-in USB so not only does it have a USB-to-Serial program & debug capability built in with no need for an FTDI-like chip, it can also act like a mouse, keyboard, USB MIDI device, etc.

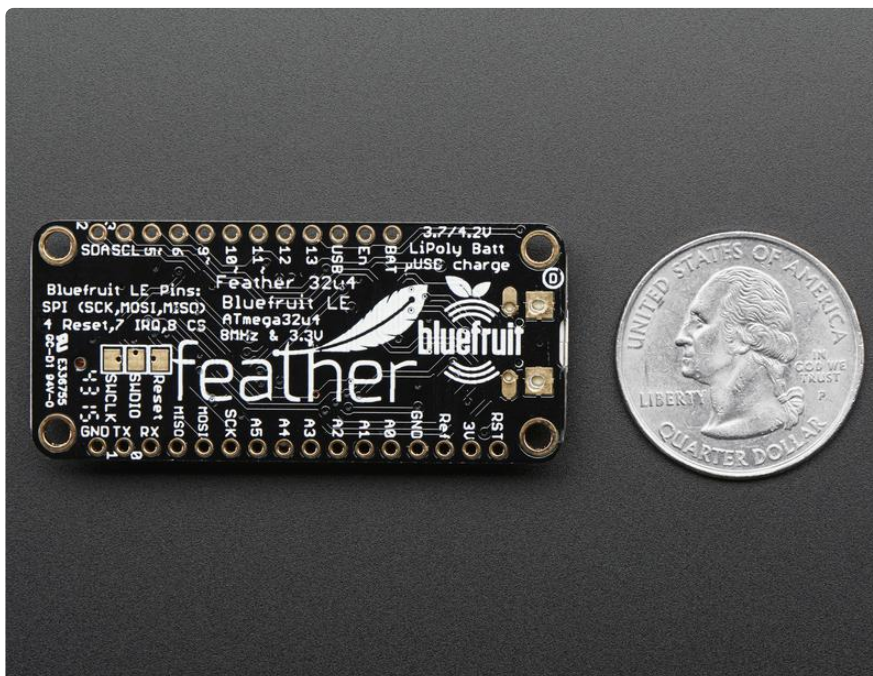

To make it easy to use for portable projects, we added a connector for any of our 3.7V Lithium polymer batteries and built-in battery charging. You don't need a battery, it will run just fine straight from the micro-USB connector. But, if you do have a battery, you can take it on the go, then plug in the USB to recharge. The Feather will automatically

switch over to USB power when its available. We also tied the battery thru a divider to an analog pin, so you can measure and monitor the battery voltage to detect when you need a recharge.

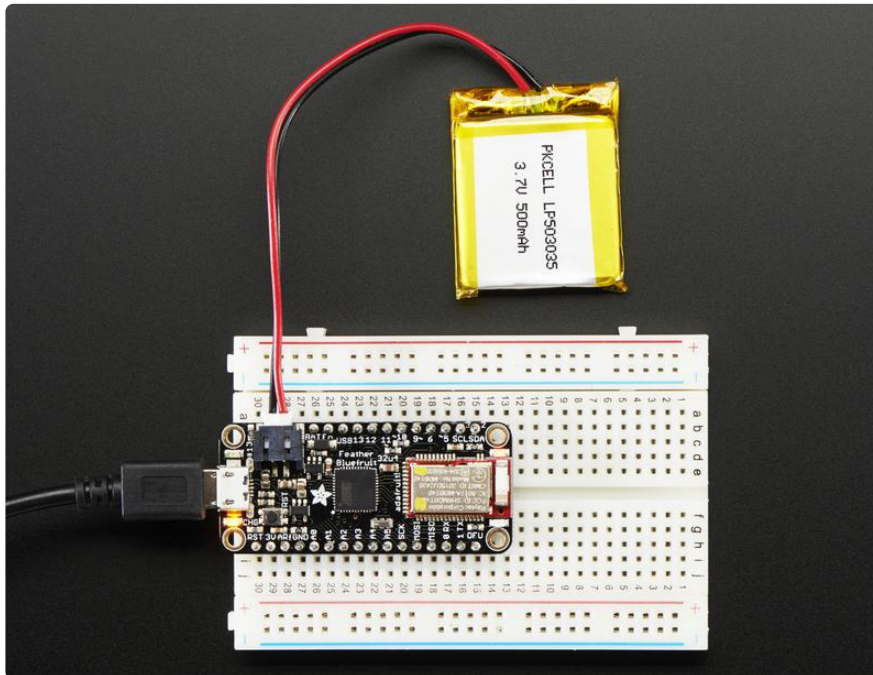

Here's some handy specs! Like all Feather 32u4's you get:

- Measures 2.0" x 0.9" x 0.28" (51mm x 23mm x 8mm) without headers soldered in
- Light as a (large?) feather - 5.7 grams
- ATmega32u4 @ 8MHz with 3.3V logic/power
- 3.3V regulator with 500mA peak current output
- USB native support, comes with USB bootloader and serial port debugging
- You also get tons of pins - 20 GPIO pins
- Hardware Serial, hardware I2C, hardware SPI support
- 7 x PWM pins
- 10 x analog inputs
- Built in 100mA lipoly charger with charging status indicator LED
- Pin #13 red LED for general purpose blinking
- Power/enable pin
- 4 mounting holes
- Reset button

The Feather 32u4 Bluefruit LE uses the extra space left over to add our excellent Bluefruit BTLE module + two status indicator LEDs



The Power of Bluefruit LE

The Bluefruit LE module is an nRF51822 chipset from Nordic, programmed with multi-function code that can do quite a lot! For most people, they'll be very happy to use the standard Nordic UART RX/TX connection profile. In this profile, the Bluefruit acts as a data pipe, that can 'transparently' transmit back and forth from your iOS or Android device. You can use our [iOS App \(https://adafru.it/iCi\)](https://adafru.it/iCi) or [Android App \(https://adafru.it/f4G\)](https://adafru.it/f4G), or [write your own to communicate with the UART service \(https://adafru.it/iCF\)](https://adafru.it/iCF).

The board is capable of much more than just sending strings over the air! Thanks to an easy to learn [AT command set \(https://adafru.it/iCG\)](https://adafru.it/iCG), you have full control over how the device behaves, including the ability to define and manipulate your own [GATT Services and Characteristics \(https://adafru.it/iCH\)](https://adafru.it/iCH), or change the way that the device advertises itself for other Bluetooth Low Energy devices to see. You can also use the AT commands to query the die temperature, check the battery voltage, and more, check the connection RSSI or MAC address, and tons more. Really, way too long to list here!

Use the Bluefruit App to get your project started

Using our Bluefruit [iOS App \(https://adafru.it/iCi\)](https://adafru.it/iCi) or [Android App \(https://adafru.it/f4G\)](https://adafru.it/f4G), you can quickly get your project prototyped by using your iOS or Android phone/tablet as a controller. We have a [color picker \(https://adafru.it/iCi\)](https://adafru.it/iCi), [quaternion/accelerometer/gyro/magnetometer or location \(GPS\) \(https://adafru.it/iCI\)](https://adafru.it/iCI), and an 8-

button [control game pad \(https://adafru.it/iCI\)](https://adafru.it/iCI). This data can be read over BLE and piped into the ATmega32u4 chip for processing & control

You can do a lot more too!

- [The Bluefruit can also act like an HID Keyboard \(https://adafru.it/iOA\)](https://adafru.it/iOA) (for devices that support BLE HID)
- [Can become a BLE Heart Rate Monitor \(https://adafru.it/iOB\)](https://adafru.it/iOB) (a standard profile for BLE) - you just need to add the pulse-detection circuitry
- [Turn it into a UriBeacon \(https://adafru.it/iOC\)](https://adafru.it/iOC), the Google standard for Bluetooth LE beacons. Just power it and the 'Friend will bleep out a URL to any nearby devices with the UriBeacon app installed.
- [Built in over-the-air bootloading capability so we can keep you updated with the hottest new firmware \(https://adafru.it/iOD\)](https://adafru.it/iOD). Use any Android or iOS device to get updates and install them. This will update the native code on the BLE module, to add new wireless capabilities, not program the ATmega chip.

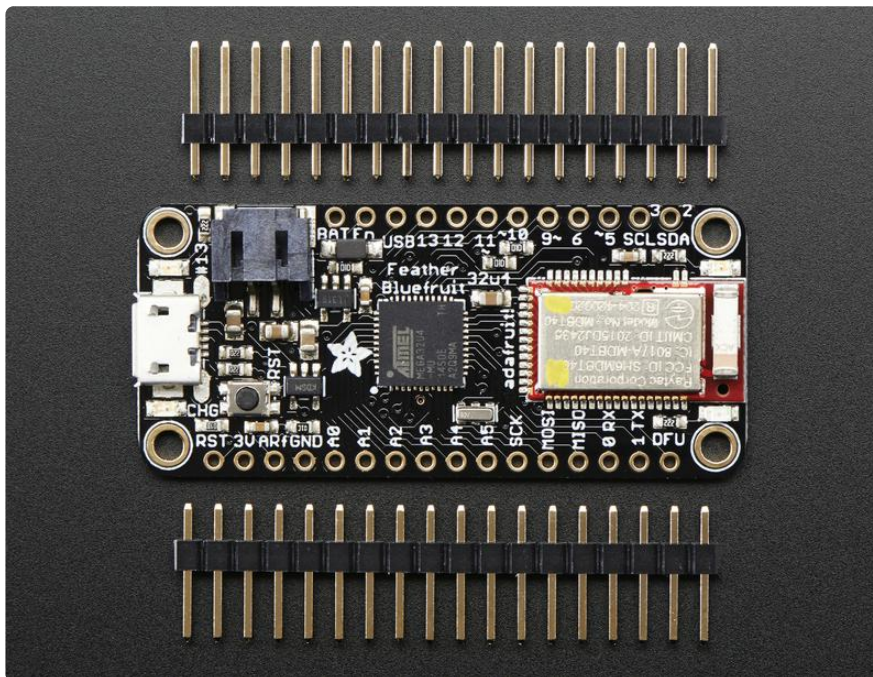

Comes fully assembled and tested, with a USB bootloader that lets you quickly use it with the Arduino IDE. We also toss in some header so you can solder it in and plug into a solderless breadboard. Lipoly battery, MicroSD card and USB cable not included (but we do have lots of options in the shop if you'd like!)

Pinouts

Adafruit Feather 32u4 Bluefruit

<https://www.adafruit.com/products/2829>

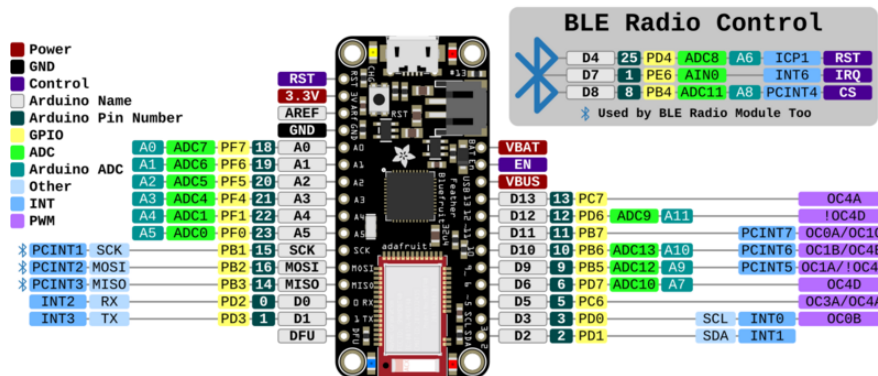

[Click here to view a PDF version of the pinout diagram \(https://adafru.it/ZBb\)](https://adafru.it/ZBb)

The Feather 32u4 Bluefruit LE is chock-full of microcontroller goodness. There's also a lot of pins and ports. We'll take you a tour of them now!

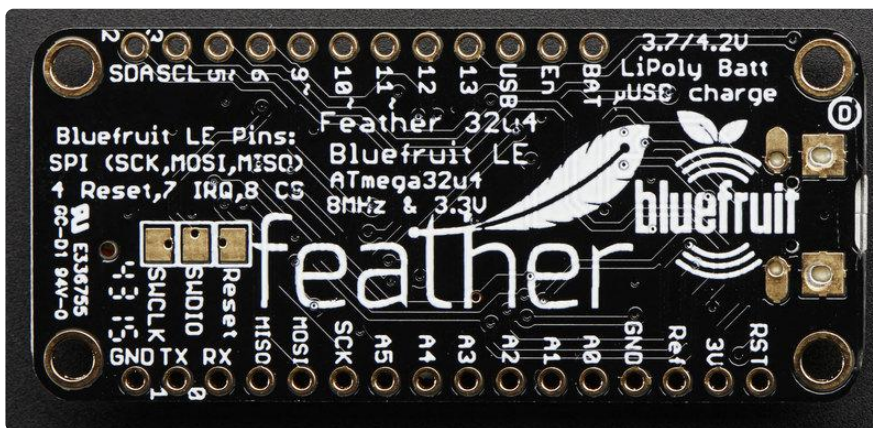
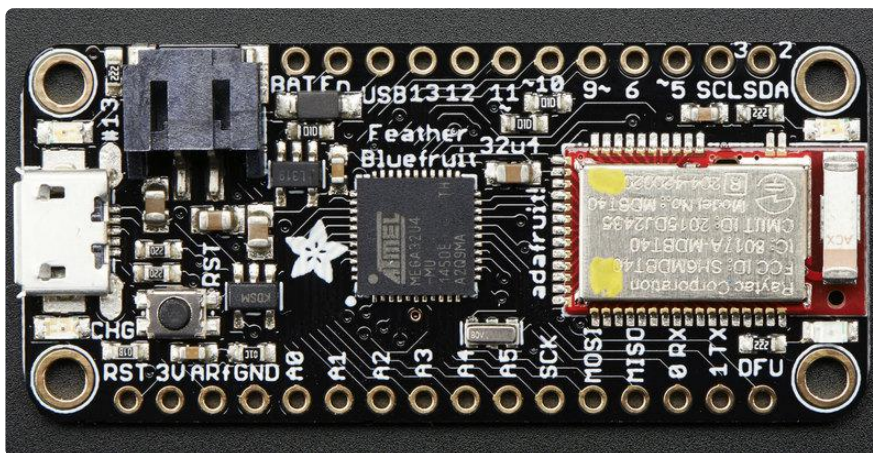

The DFU pin is accidentally labeled GND on the bottom, sorry about that! it should be labeled DFU, dont use it as a GND

Power Pins

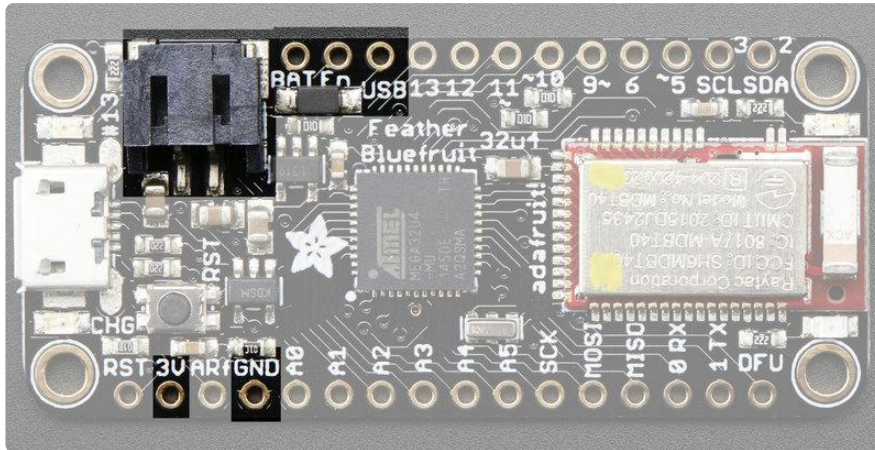

- GND - this is the common ground for all power and logic
- BAT - this is the positive voltage to/from the JST jack for the optional Lipoly battery
- USB - this is the positive voltage to/from the micro USB jack if connected
- EN - this is the 3.3V regulator's enable pin. It's pulled up, so connect to ground to disable the 3.3V regulator
- 3V - this is the output from the 3.3V regulator, it can supply 500mA peak

Logic pins

This is the general purpose I/O pin set for the microcontroller. All logic is 3.3V

- #0 / RX - GPIO #0, also receive (input) pin for Serial1 and Interrupt #2
- #1 / TX - GPIO #1, also transmit (output) pin for Serial1 and Interrupt #3
- #2 / SDA - GPIO #2, also the I2C (Wire) data pin. There's no pull up on this pin by default so when using with I2C, you may need a 2.2K-10K pullup. Also Interrupt #1
- #3 / SCL - GPIO #3, also the I2C (Wire) clock pin. There's no pull up on this pin by default so when using with I2C, you may need a 2.2K-10K pullup. Can also do PWM output and act as Interrupt #0.
- #5 - GPIO #5, can also do PWM output
- #6 - GPIO #6, can also do PWM output and analog input A7
- #9 - GPIO #9, also analog input A9 and can do PWM output. This analog input is connected to a voltage divider for the lipoly battery so be aware that this pin naturally 'sits' at around 2VDC due to the resistor divider
- #10 - GPIO #10, also analog input A10 and can do PWM output.

- #11 - GPIO #11, can do PWM output.
- #12 - GPIO #12, also analog input A11
- #13 - GPIO #13, can do PWM output and is connected to the red LED next to the USB jack
- A0 thru A5 - These are each analog input as well as digital I/O pins.
- SCK/MOSI/MISO - These are the hardware SPI pins, used by the Bluefruit LE module too! You can use them as everyday GPIO pins if you don't activate the Bluefruit and keep the BLE CS pin high. However, we really recommend keeping them free as they should be kept available for the Bluefruit. If they are used, make sure its with a device that will kindly share the SPI bus! Also used to reprogram the chip with an AVR programmer if you need.

Bluefruit LE Module + Indicator LEDs

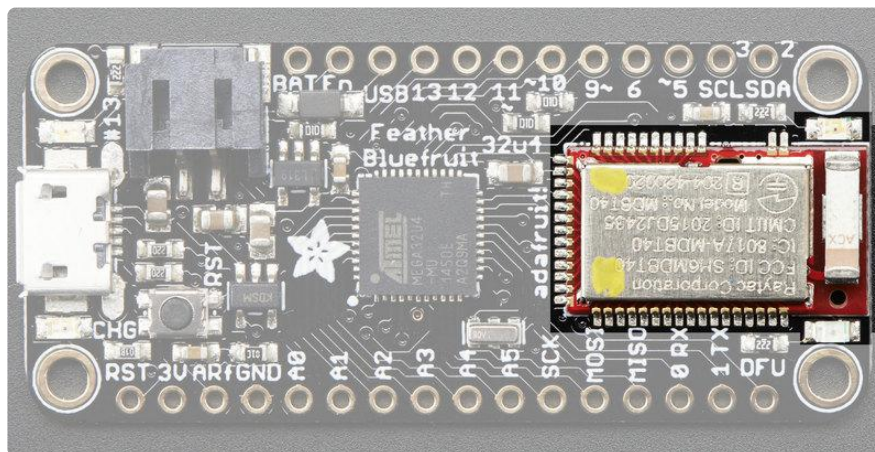

Since not all pins can be brought out to breakouts, due to the small size of the Feather, we use these to control the BLE module

- #8 - used as the Bluefruit CS (chip select) pin
- #7 - used as the Bluefruit IRQ (interrupt request) pin.
- #4 - used as the Bluefruit Reset pin

Since these are not brought out there should be no risk of using them by accident!

Other Pins!

Top Side

- RST - this is the Reset pin, tie to ground to manually reset the AVR, as well as launch the bootloader manually

- ARef - the analog reference pin. Normally the reference voltage is the same as the chip logic voltage (3.3V) but if you need an alternative analog reference, connect it to this pin and select the external AREF in your firmware. Can't go higher than 3.3V!
- DFU - this is the force-DFU (device firmware upgrade) pin for over-the-air updates to the Bluefruit module. You probably don't need to use this but its available if you need to upgrade! Check out the DFU Bluefruit Upgrades page for how to use it. Otherwise, keep it disconnected.

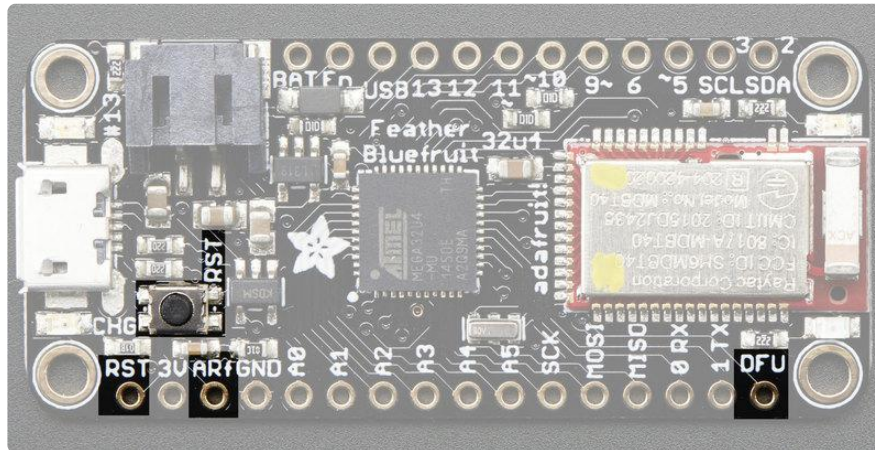

Bottom Side

On the back we also have SWDIO/SWCLK/RESET pins, these are used for programming the Bluefruit LE module itself.

SWD Debug Input

You normally should not connect to the SWDIO and SWCLK pins unless you want to wipe out the Bluefruit LE module firmware for some reason, such as flashing an entirely custom firmware image written by yourself, though this is entirely at your own risk since it will wipe the Bluefruit firmware! Flashing firmware or using the SWD interface will require something like a [Segger J-Link EDU Mini \(https://adafruit.it/yDp\)](https://adafruit.it/yDp) to communicate via the debug controller inside the nRF51822.

Factory Reset

The Reset pad (not to be confused with the 0.1" circular RST pin!) is the factory reset pin, which is also rarely used, but you can use it to set the module back to the factory default settings if it gets really messed up. Connect the 'Reset' pin to GND when you boot the device up to force a factory reset in HW (via the bootloader).

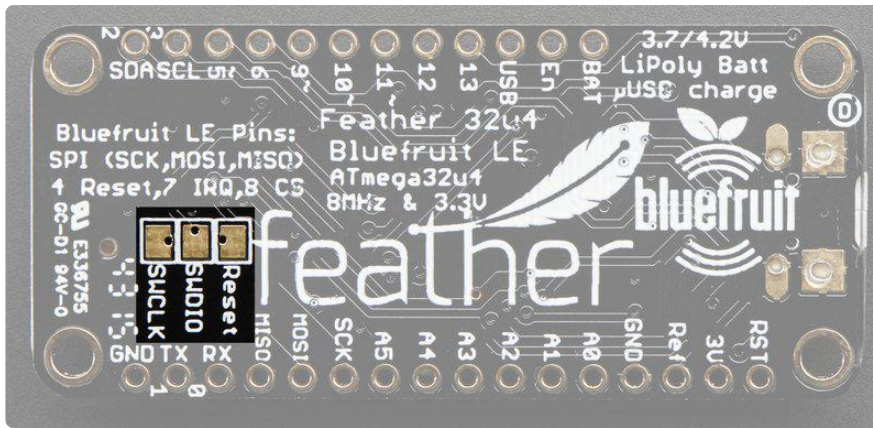

Assembly

We ship Feathers fully tested but without headers attached - this gives you the most flexibility on choosing how to use and configure your Feather

Header Options!

Before you go gung-ho on soldering, there's a few options to consider!

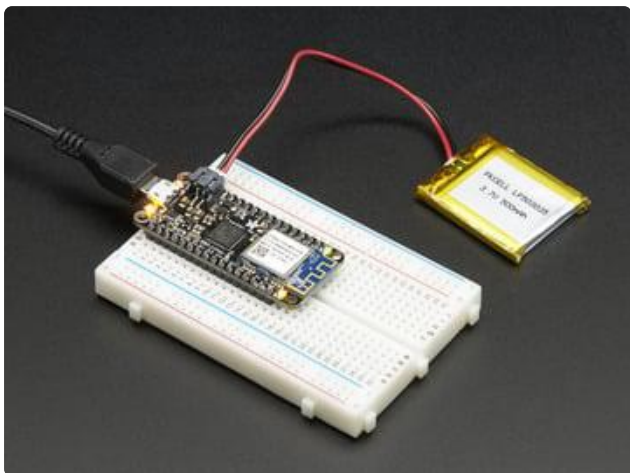

The first option is soldering in plain male headers, this lets you plug in the Feather into a solderless breadboard

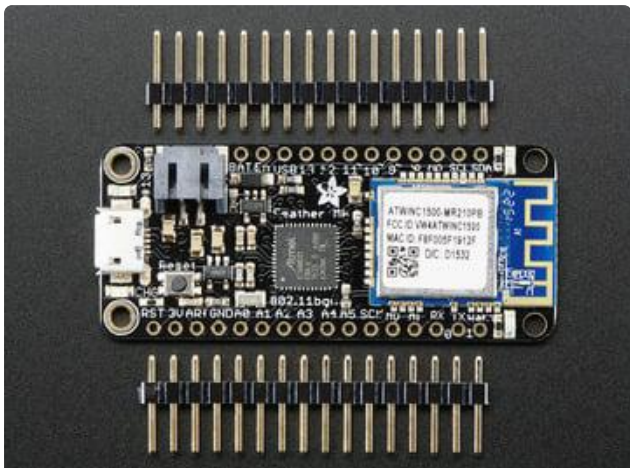

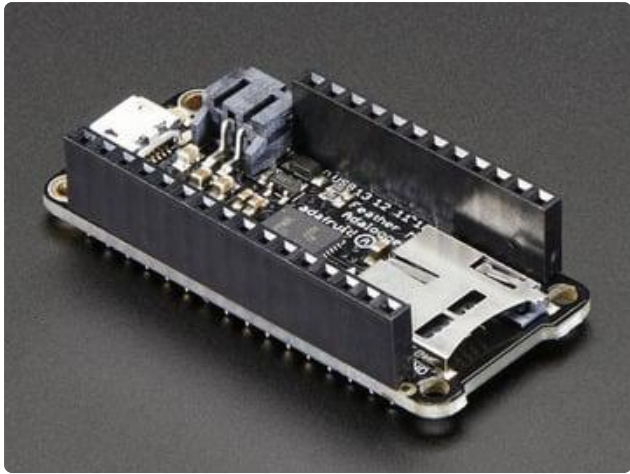

Another option is to go with socket female headers. This won't let you plug the Feather into a breadboard but it will let you attach featherwings very easily

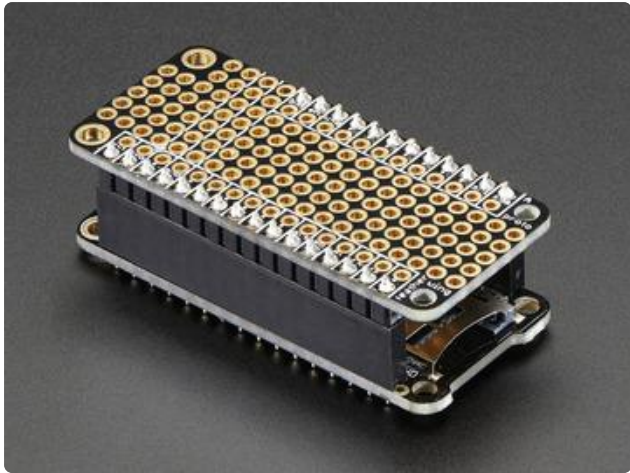

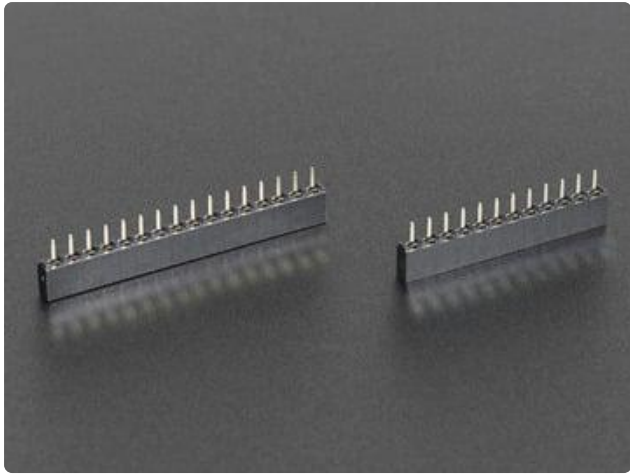

We also have 'slim' versions of the female headers, that are a little shorter and give a more compact shape

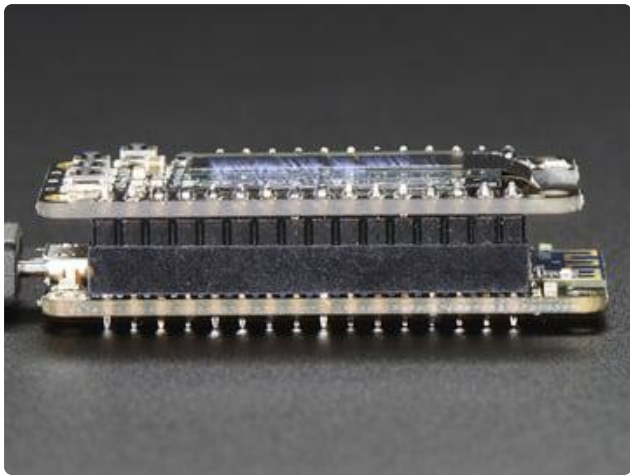

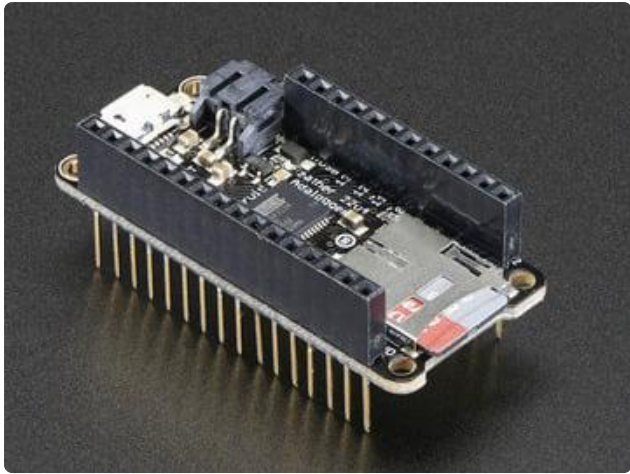

Finally, there's the "Stacking Header" option. This one is sort of the best-of-both-worlds. You get the ability to plug into a solderless breadboard and plug a featherwing on top. But its a little bulky

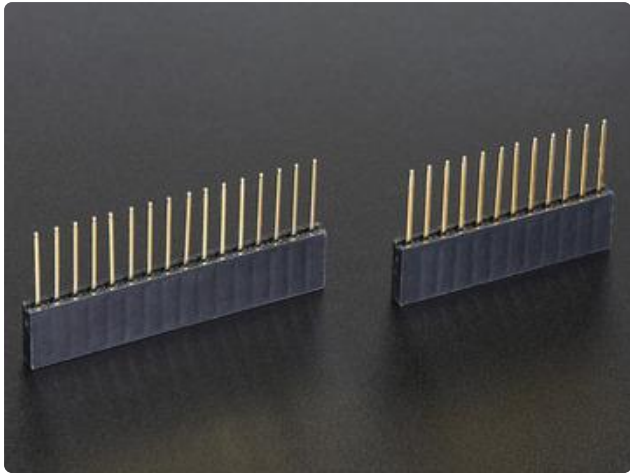

Soldering in Plain Headers

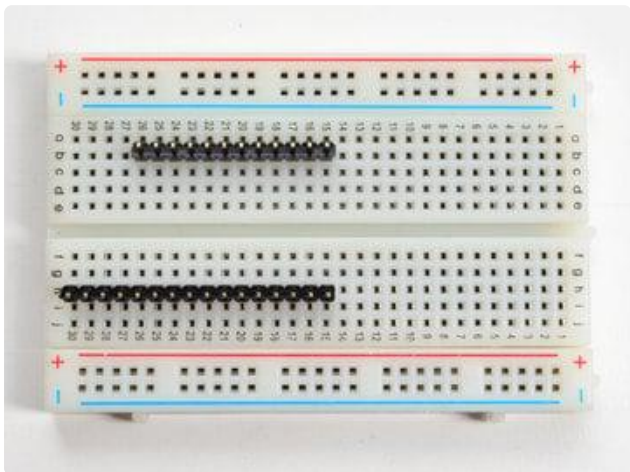

Prepare the header strip:
Cut the strip to length if necessary. It will be easier to solder if you insert it into a breadboard - long pins down

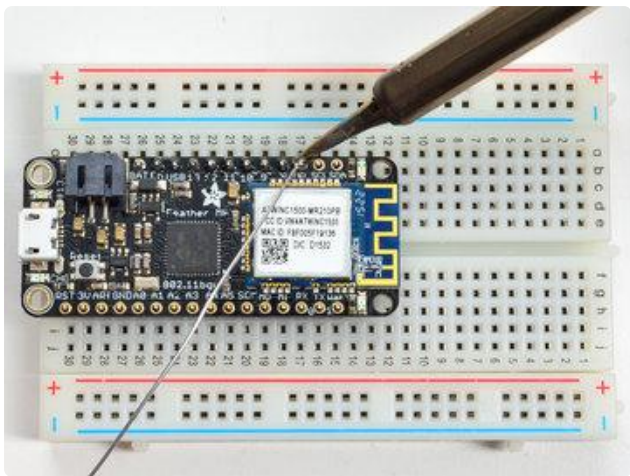
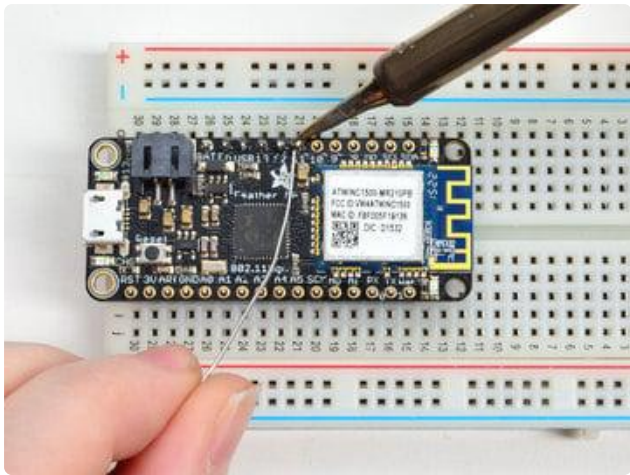
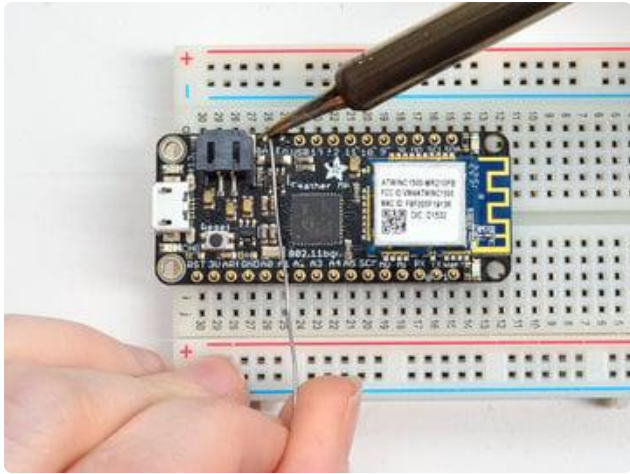

Add the breakout board:

Place the breakout board over the pins so that the short pins poke through the breakout pads

And Solder!

Be sure to solder all pins for reliable electrical contact.

(For tips on soldering, be sure to check out our [Guide to Excellent Soldering \(https://adafruit.it/aTk\)](https://adafruit.it/aTk)).

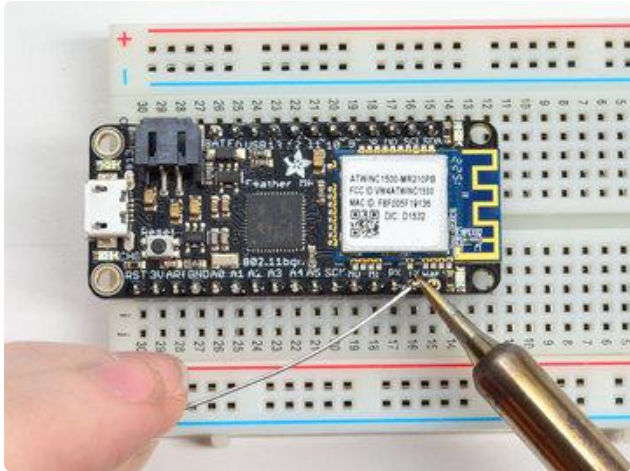
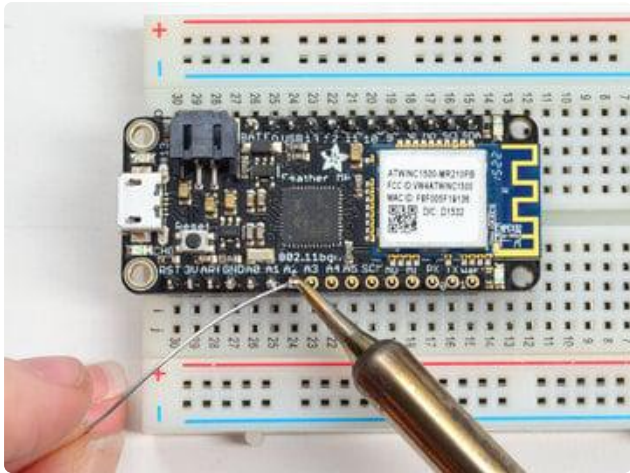
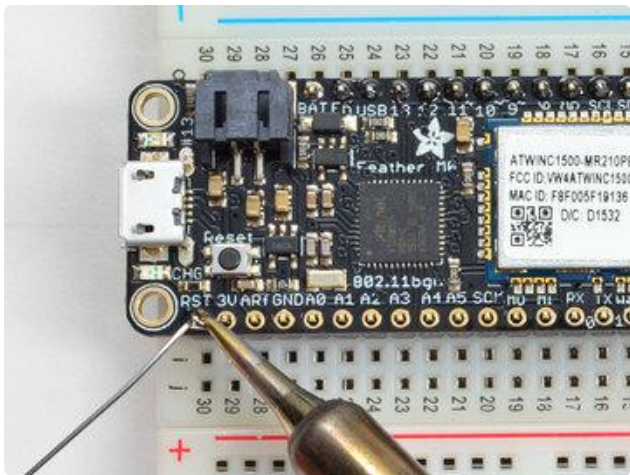

Solder the other strip as well.

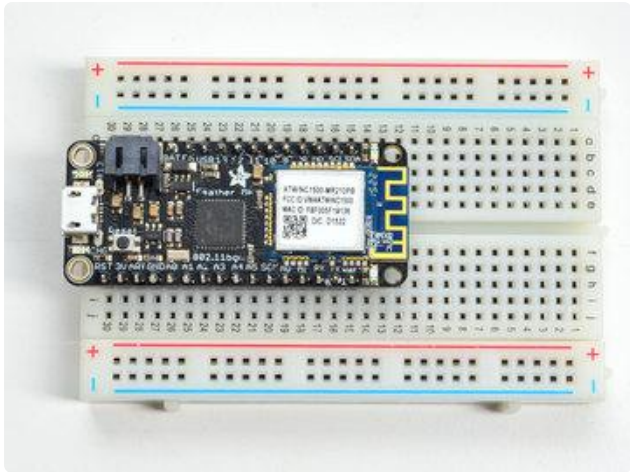

You're done! Check your solder joints visually and continue onto the next steps

Soldering on Female Header



Tape In Place

For sockets you'll want to tape them in place so when you flip over the board they don't fall out

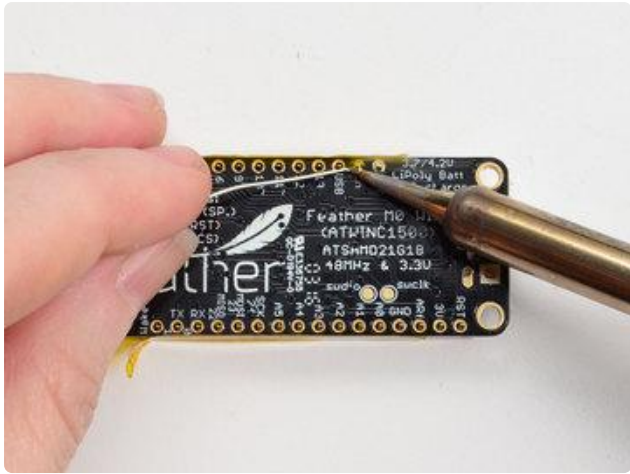

Flip & Tack Solder

After flipping over, solder one or two points on each strip, to 'tack' the header in place

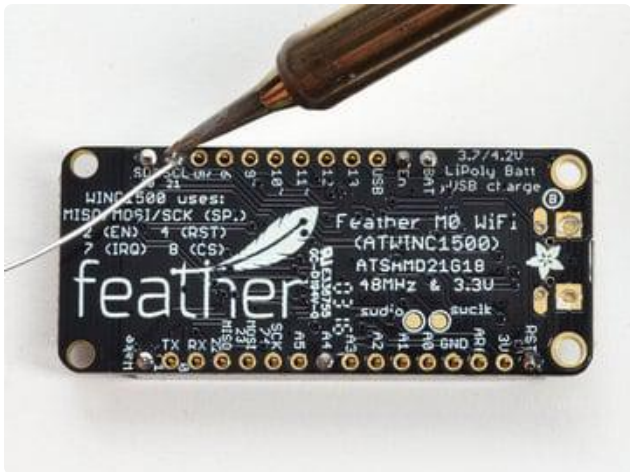
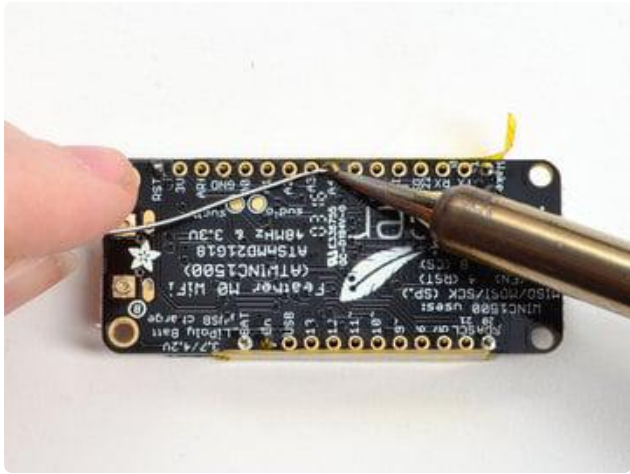

And Solder!

Be sure to solder all pins for reliable electrical contact.

(For tips on soldering, be sure to check out our [Guide to Excellent Soldering \(https://adafruit.it/aTk\)](https://adafruit.it/aTk)).

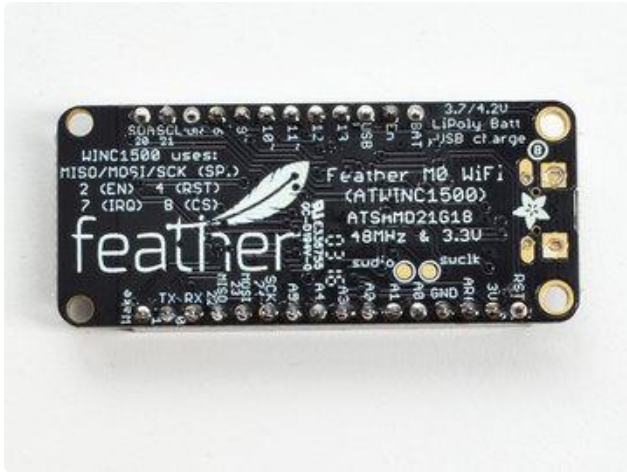

You're done! Check your solder joints visually and continue onto the next steps



Power Management

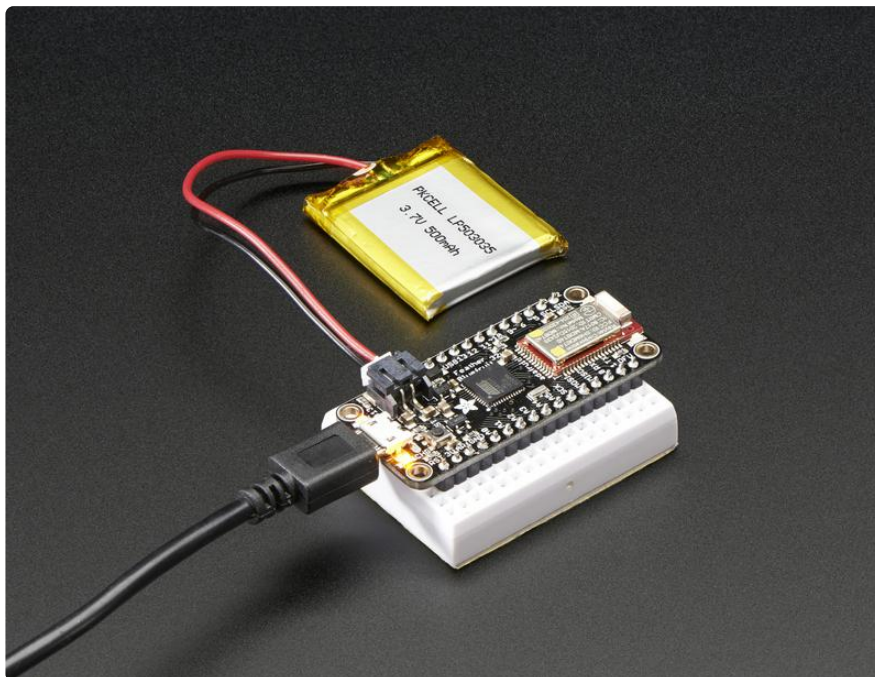

Battery + USB Power

We wanted to make our Feather boards easy to power both when connected to a computer as well as via battery.

There's two ways to power a Feather:

1. You can connect with a USB cable (just plug into the jack) and the Feather will regulate the 5V USB down to 3.3V.
2. You can also connect a 4.2/3.7V Lithium Polymer (LiPo/LiPoly) or Lithium Ion (Lilon) battery to the JST jack. This will let the Feather run on a rechargeable battery.

When the USB power is powered, it will automatically switch over to USB for power, as well as start charging the battery (if attached). This happens 'hot-swap' style so you can always keep the LiPoly connected as a 'backup' power that will only get used when USB power is lost.

The JST connector polarity is matched to Adafruit LiPoly batteries. Using wrong polarity batteries can destroy your Feather.

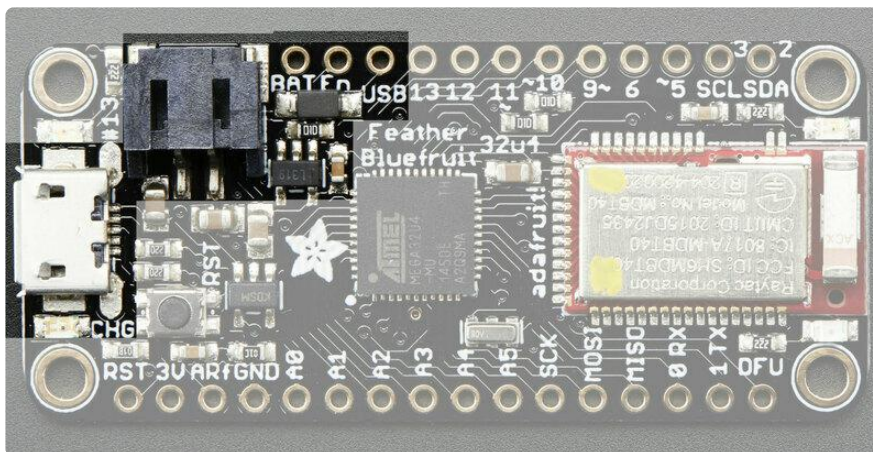

The above shows the Micro USB jack (left), LiPoly JST jack (top left), as well as the 3.3V regulator and changeover diode (just to the right of the JST jack) and the LiPoly charging circuitry (to the right of the Reset button).

There's also a CHG LED next to the USB jack, which will light up while the battery is charging. This LED might also flicker if the battery is not connected, it's normal.

The charge LED is automatically driven by the LiPoly charger circuit. It will try to detect a battery and is expecting one to be attached. If there isn't one it may

flicker once in a while when you use power because it's trying to charge a (non-existent) battery. It's not harmful, and its totally normal!

Power Supplies

You have a lot of power supply options here! We bring out the BAT pin, which is tied to the LiPoly JST connector, as well as USB which is the +5V from USB if connected. We also have the 3V pin which has the output from the 3.3V regulator. We use a 500mA peak regulator. While you can get 500mA from it, you can't do it continuously from 5V as it will overheat the regulator.

It's fine for, say, powering an ESP8266 WiFi chip or XBee radio though, since the current draw is 'spiky' & sporadic.

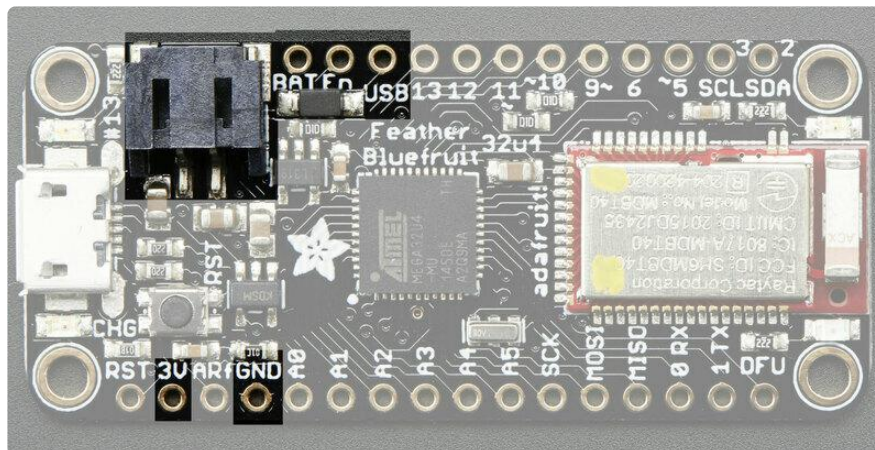

Measuring Battery

If you're running off of a battery, chances are you wanna know what the voltage is at! That way you can tell when the battery needs recharging. LiPoly batteries are 'maxed out' at 4.2V and stick around 3.7V for much of the battery life, then slowly sink down to 3.2V or so before the protection circuitry cuts it off. By measuring the voltage you can quickly tell when you're heading below 3.7V.

To make this easy we stuck a double-100K resistor divider on the BAT pin, and connected it to D9 (a.k.a analog #9 A9). You can read this pin's voltage, then double it, to get the battery voltage.

```
#define VBATPIN A9

float measuredvbat = analogRead(VBATPIN);
measuredvbat *= 2; // we divided by 2, so multiply back
measuredvbat *= 3.3; // Multiply by 3.3V, our reference voltage
```

```
measuredvbat /= 1024; // convert to voltage
Serial.print("VBat: " ); Serial.println(measuredvbat);
```

This voltage will 'float' at 4.2V when no battery is plugged in, due to the lipoly charger output, so its not a good way to detect if a battery is plugged in or not (there is no simple way to detect if a battery is plugged in)

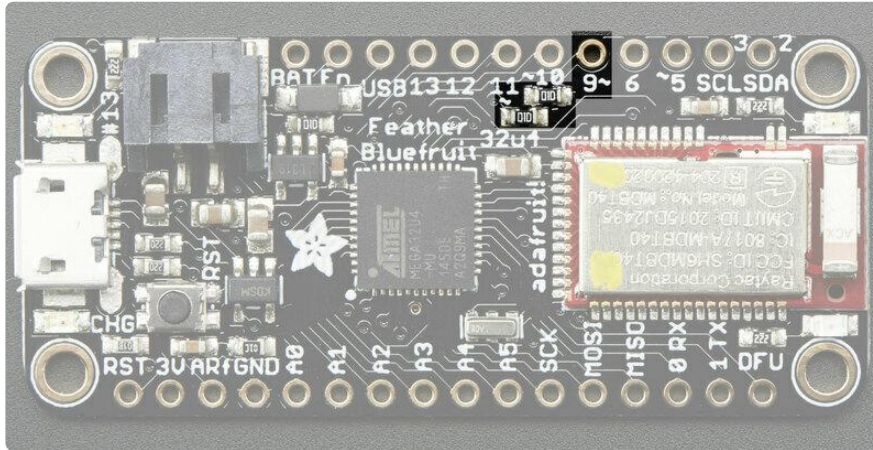

ENable pin

If you'd like to turn off the 3.3V regulator, you can do that with the EN(able) pin. Simply tie this pin to Ground and it will disable the 3V regulator. The BAT and USB pins will still be powered.

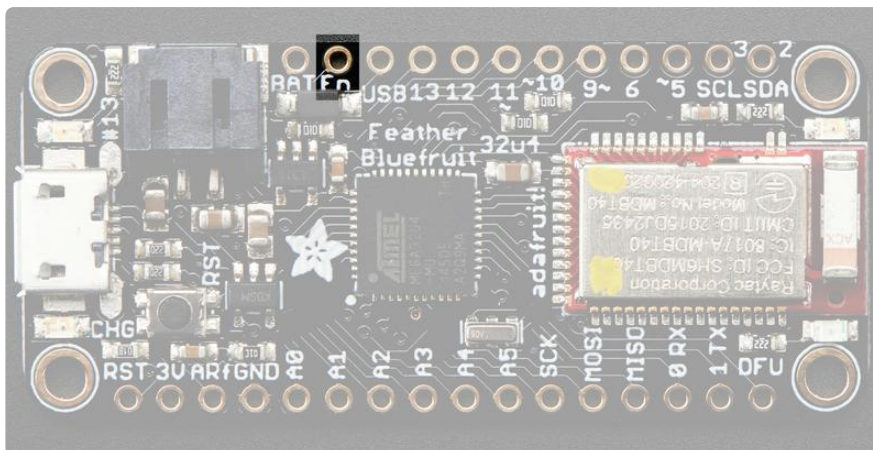

Alternative Power Options

The two primary ways for powering a feather are a 3.7/4.2V LiPo battery plugged into the JST port or a USB power cable.

If you need other ways to power the Feather, here's what we recommend:

- For permanent installations, a [5V 1A USB wall adapter \(https://adafru.it/duP\)](https://adafru.it/duP) will let you plug in a USB cable for reliable power
- For mobile use, where you don't want a LiPoly, [use a USB battery pack! \(https://adafru.it/e2q\)](https://adafru.it/e2q)
- If you have a higher voltage power supply, [use a 5V buck converter \(https://adafru.it/DHs\)](https://adafru.it/DHs) and wire it to a [USB cable's 5V and GND input \(https://adafru.it/DHu\)](https://adafru.it/DHu)

Here's what you cannot do:

- Do not use alkaline or NiMH batteries and connect to the battery port - this will destroy the LiPoly charger and there's no way to disable the charger
- Do not use 7.4V RC batteries on the battery port - this will destroy the board

The Feather is not designed for external power supplies - this is a design decision to make the board compact and low cost. It is not recommended, but technically possible:

- Connect an external 3.3V power supply to the 3V and GND pins. Not recommended, this may cause unexpected behavior and the EN pin will no longer work. Also this doesn't provide power on BAT or USB and some Feathers/Wings use those pins for high current usages. You may end up damaging your Feather.
- Connect an external 5V power supply to the USB and GND pins. Not recommended, this may cause unexpected behavior when plugging in the USB port because you will be back-powering the USB port, which could confuse or damage your computer.

Arduino IDE Setup

The first thing you will need to do is to download the latest release of the Arduino IDE. You will need to be using version 1.8 or higher for this guide

Arduino IDE Download

<https://adafru.it/f1P>

After you have downloaded and installed the latest version of Arduino IDE, you will need to start the IDE and navigate to the Preferences menu. You can access it from the File menu in Windows or Linux, or the Arduino menu on OS X.

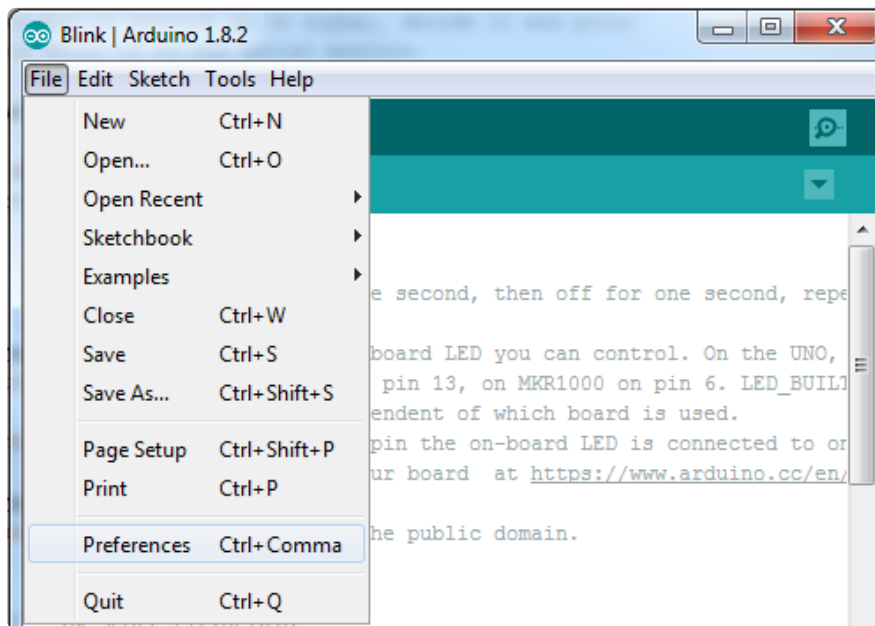

A dialog will pop up just like the one shown below.

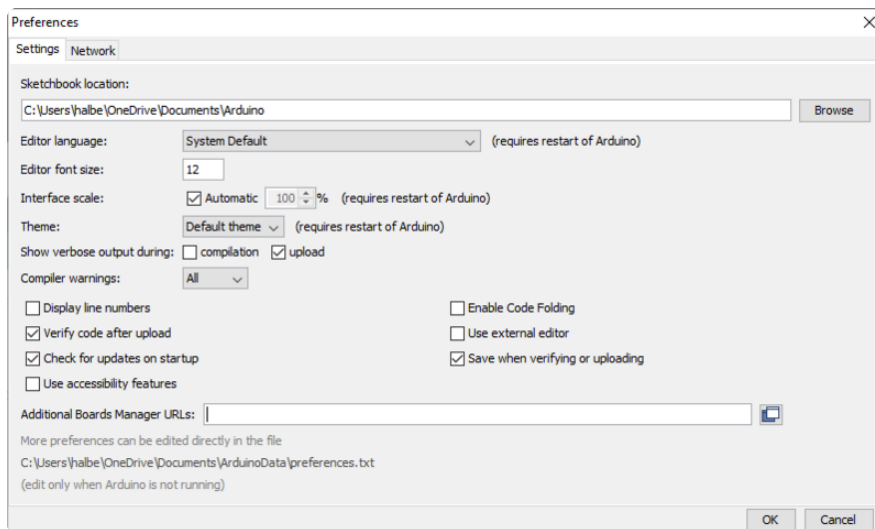

We will be adding a URL to the new Additional Boards Manager URLs option. The list of URLs is comma separated, and you will only have to add each URL once. New Adafruit boards and updates to existing boards will automatically be picked up by the Board Manager each time it is opened. The URLs point to index files that the Board Manager uses to build the list of available & installed boards.

To find the most up to date list of URLs you can add, you can visit the list of [third party board URLs on the Arduino IDE wiki \(https://adafru.it/f7U\)](https://adafru.it/f7U). We will only need to add one URL to the IDE in this example, but you can add multiple URLs by separating

them with commas. Copy and paste the link below into the Additional Boards Manager URLs option in the Arduino IDE preferences.

https://adafruit.github.io/arduino-board-index/package_adafruit_index.json

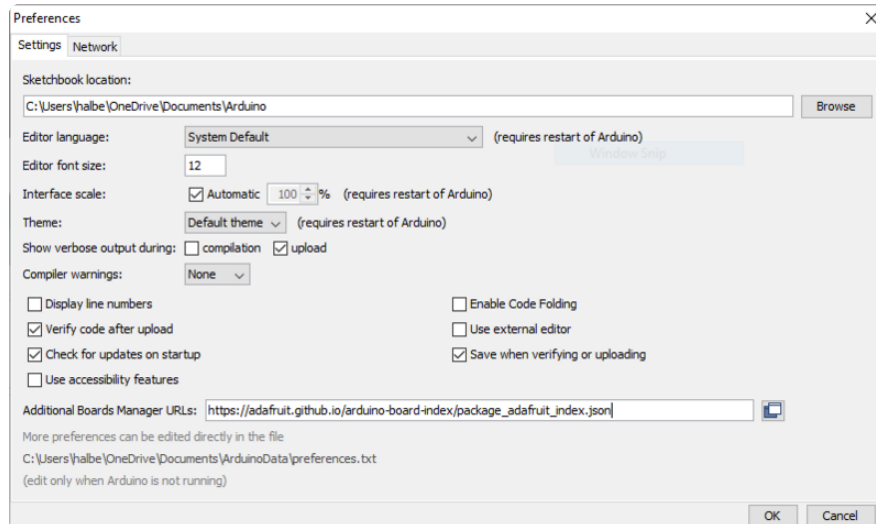

Here's a short description of each of the Adafruit supplied packages that will be available in the Board Manager when you add the URL:

- Adafruit AVR Boards - Includes support for Flora, Gemma, Feather 32u4, ItsyBitsy 32u4, Trinket, & Trinket Pro.
- Adafruit SAMD Boards - Includes support for Feather M0 and M4, Metro M0 and M4, ItsyBitsy M0 and M4, Circuit Playground Express, Gemma M0 and Trinket M0
- Arduino Leonardo & Micro MIDI-USB - This adds MIDI over USB support for the Flora, Feather 32u4, Micro and Leonardo using the [arcore project \(https://adafru.it/eSI\)](https://adafru.it/eSI).

If you have multiple boards you want to support, say ESP8266 and Adafruit, have both URLs in the text box separated by a comma (,)

Once done click OK to save the new preference settings. Next we will look at installing boards with the Board Manager.

Now continue to the next step to actually install the board support package!

Using with Arduino IDE

Since the Feather 32u4 uses an ATmega32u4 chip running at 8 MHz, you can pretty easily get it working with the Arduino IDE. Many libraries (including the popular ones like NeoPixels and display) work great with the '32u4 and 8 MHz clock speed.

Now that you have added the appropriate URLs to the Arduino IDE preferences, you can open the Boards Manager by navigating to the Tools->Board menu.

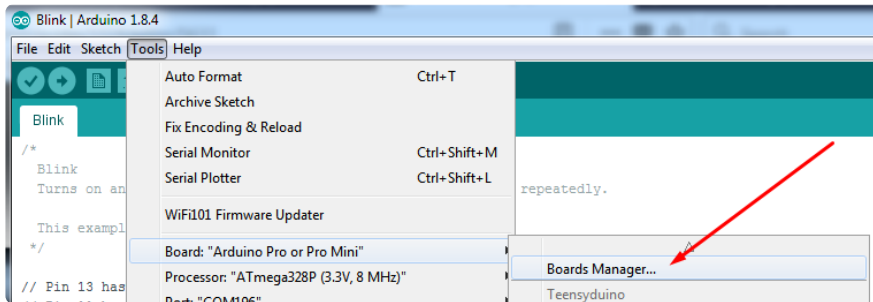

Once the Board Manager opens, click on the category drop down menu on the top left hand side of the window and select Contributed. You will then be able to select and install the boards supplied by the URLs added to the preferences. In the example below, we are installing support for Adafruit AVR Boards, but the same applies to all boards installed with the Board Manager.

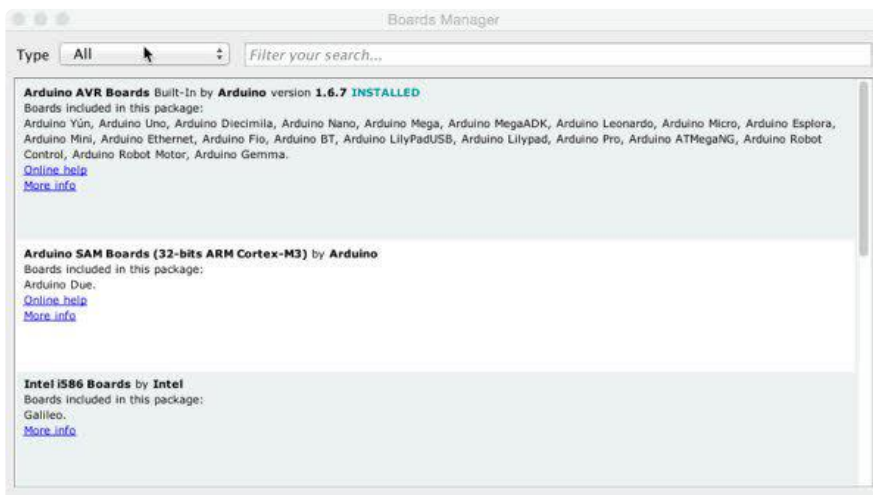

Next, quit and reopen the Arduino IDE to ensure that all of the boards are properly installed. You should now be able to select and upload to the new boards listed in the Tools->Board menu.

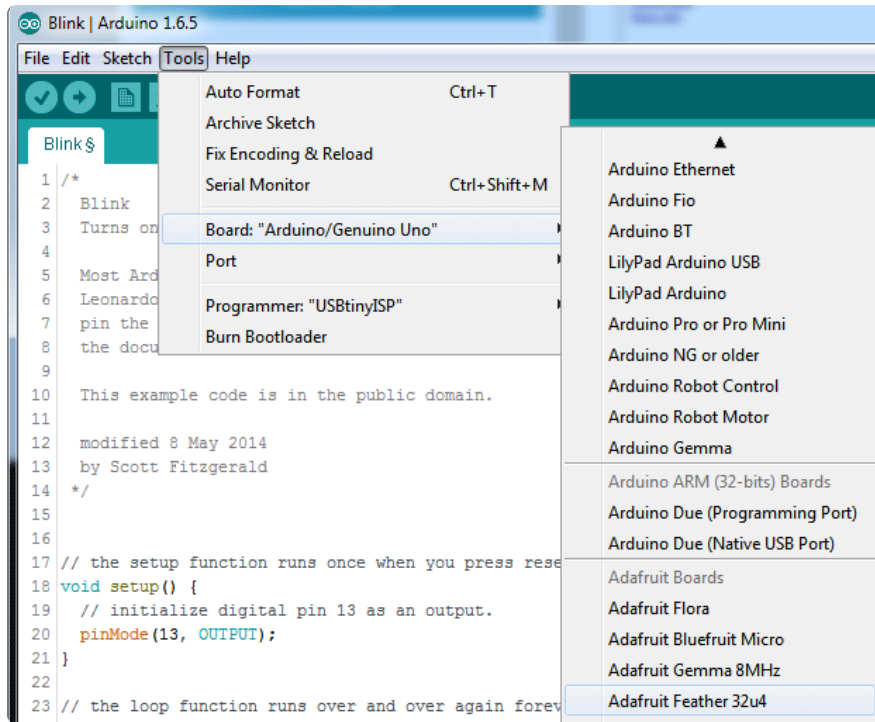

Install Drivers (Windows 7 Only)

When you plug in the Feather, you'll need to possibly install a driver

Windows 10 folks can skip this, the drivers now come built into Windows 10!

Click below to download our Driver Installer

[Download Adafruit Drivers Installer](https://adafru.it/AB0)

<https://adafru.it/AB0>

Download and run the installer

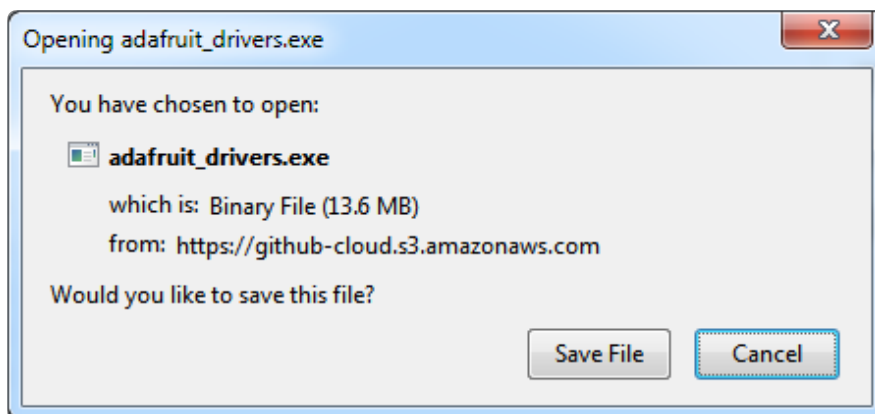

Run the installer! Since we bundle the SiLabs and FTDI drivers as well, you'll need to click through the license

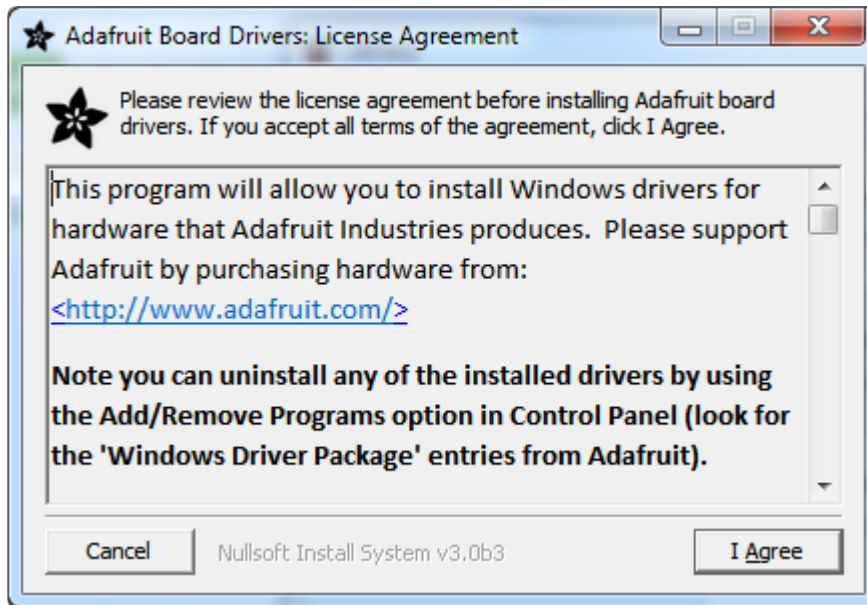

Select which drivers you want to install:

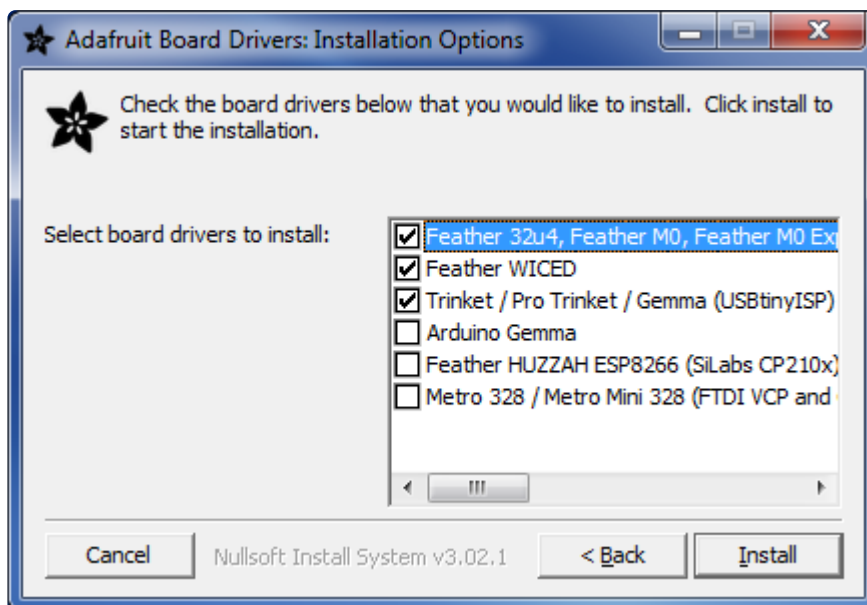

Click Install to do the installin'

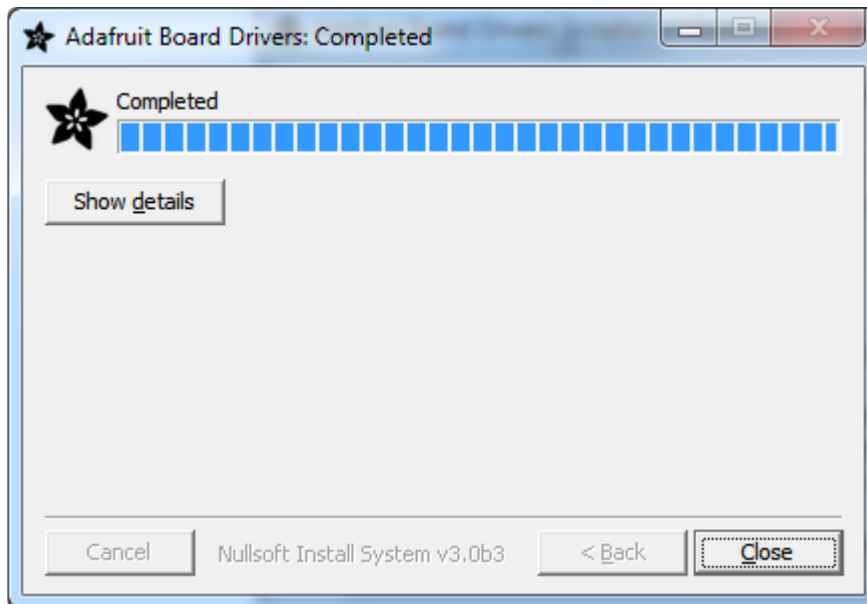

Blink

Now you can upload your first blink sketch!

Plug in the Feather 32u4 and wait for it to be recognized by the OS (just takes a few seconds). It will create a serial/COM port, you can now select it from the dropdown, it'll even be 'indicated' as Feather 32u4!

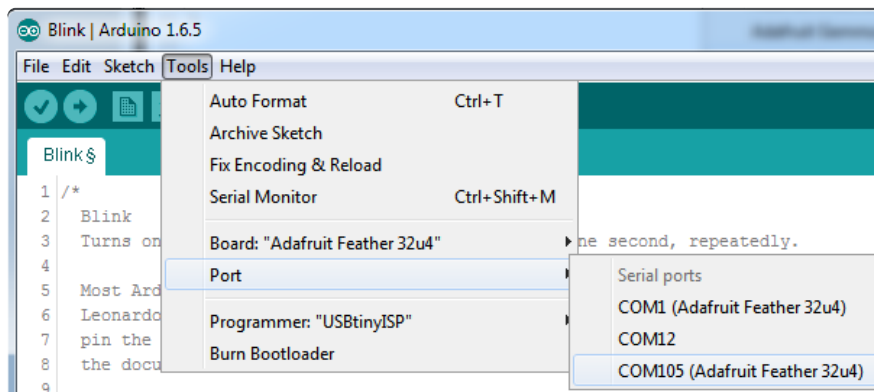

Now load up the Blink example

```
// the setup function runs once when you press reset or power the board
void setup() {
  // initialize digital pin 13 as an output.
  pinMode(13, OUTPUT);
}

// the loop function runs over and over again forever
void loop() {
  digitalWrite(13, HIGH); // turn the LED on (HIGH is the voltage level)
  delay(1000);           // wait for a second
  digitalWrite(13, LOW); // turn the LED off by making the voltage LOW
}
```

```
    delay(1000);           // wait for a second
  }
```

And click upload! That's it, you will be able to see the LED blink rate change as you adapt the delay() calls.

Manually bootloading

If you ever get in a 'weird' spot with the bootloader, or you have uploaded code that crashes and doesn't auto-reboot into the bootloader, double-click the RST button to get back into the bootloader. The red LED will pulse, so you know that its in bootloader mode. Do the reset button double-press right as the Arduino IDE says its attempting to upload the sketch, when you see the Yellow Arrow lit and the Uploading ... text in the status bar.

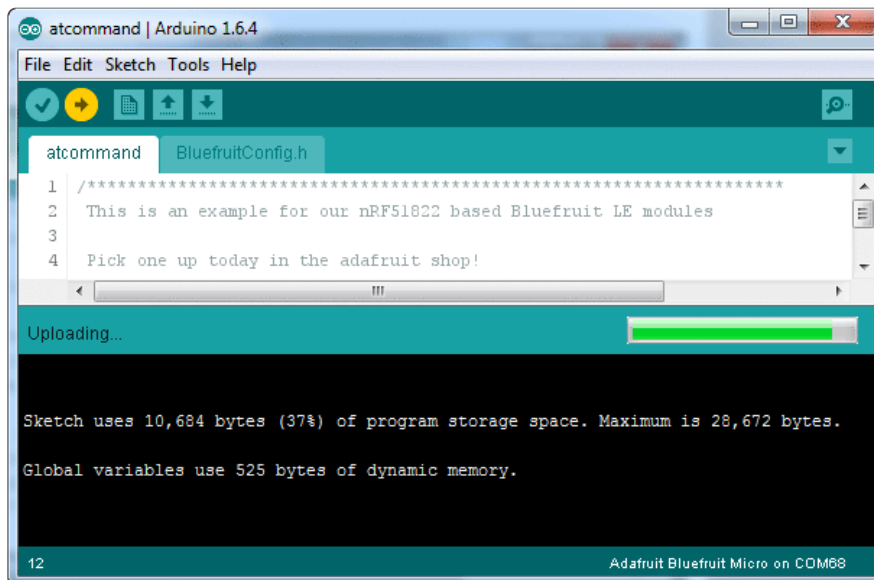

Don't click the reset button before uploading, unlike other bootloaders you want this one to run at the time Arduino is trying to upload

Ubuntu & Linux Issue Fix

If you're on Linux, and are seeing multi-second delays connecting to the serial console, or are seeing "AT" and other gibberish when you connect, [follow the steps on this page. \(https://adafru.it/iOE\)](https://adafru.it/iOE)

Installing BLE Library

Install the Adafruit nRF51 BLE Library

In order to try out our demos, you'll need to download the Adafruit BLE library for the nRF51 based modules such as this one (a.k.a. Adafruit_BluefruitLE_nRF51)

[You can check out the code here at github, \(https://adafru.it/f4V\)](https://adafru.it/f4V) but its likely easier to just download via the Arduino library manager.

Open up the Arduino library manager:

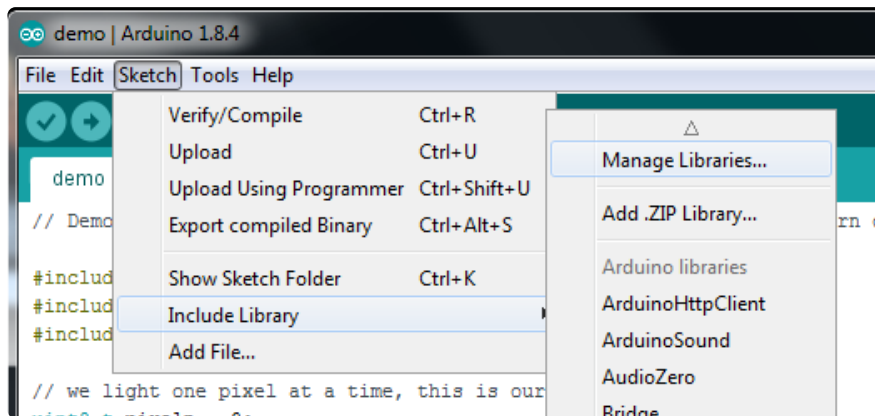

Search for the Adafruit BluefruitLE nRF51 library and install it



We also have a great tutorial on Arduino library installation at:

<http://learn.adafruit.com/adafruit-all-about-arduino-libraries-install-use> (<https://adafru.it/aYM>)

Check that you see the library folder with examples:

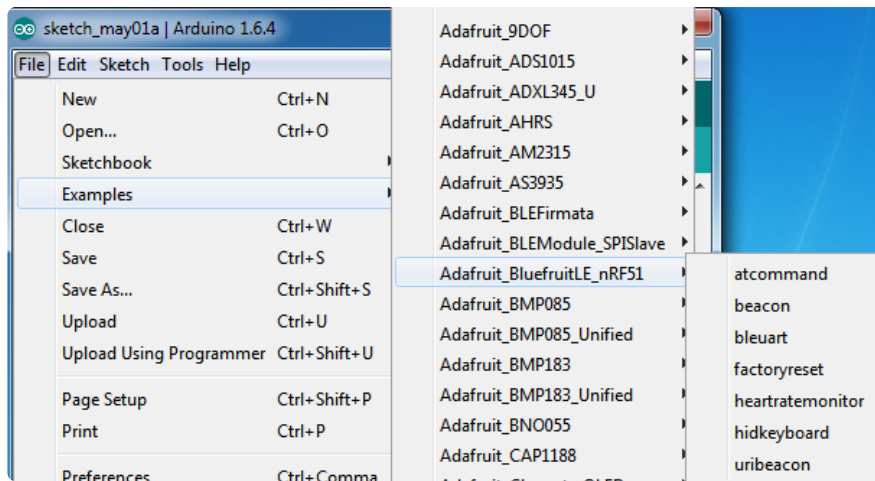

Run first example

Lets begin with the beginner project, which we can use to do basic tests. To open the ATCommand sketch, click on the File > Examples > Adafruit_BluefruitLE_nRF51 folder in the Arduino IDE and select atcommand:

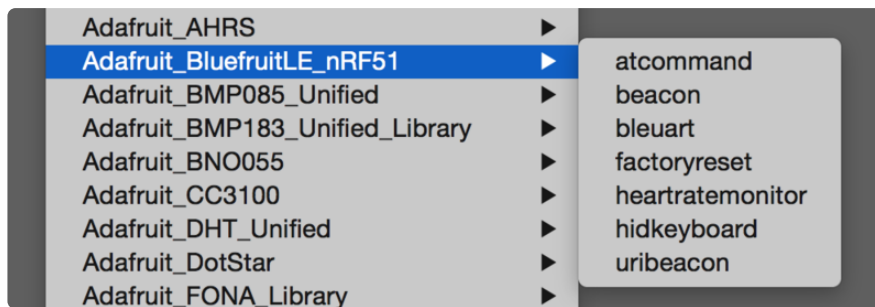

This will open up a new instance of the example in the IDE, as shown below:



Don't upload the sketch yet! You will have to begin by changing the configuration.

Go to the second tab labeled BluefruitConfig.h and find these lines

```
// SHARED SPI SETTINGS
//
-----
// The following macros declare the pins to use for HW and SW SPI communication.
// SCK, MISO and MOSI should be connected to the HW SPI pins on the Uno when
// using HW SPI. This should be used with nRF51822 based Bluefruit LE modules
// that use SPI (Bluefruit LE SPI Friend).
//
-----
#define BLUEFRUIT_SPI_CS           8
#define BLUEFRUIT_SPI_IRQ         7
#define BLUEFRUIT_SPI_RST         6    // Optional but recommended, set to -1
if unused
```

And change the last line to:

```
#define BLUEFRUIT_SPI_RST         4    // Optional but recommended, set to -1
if unused
```

(The Bluefruit Feather has the reset on digital #4 not #6)

Now go back to the main tab atcommand and look for this line of code

```
/* ...hardware SPI, using SCK/MOSI/MISO hardware SPI pins and then user selected CS/
IRQ/RST */
Adafruit_BluefruitLE_SPI ble(BLUEFRUIT_SPI_CS, BLUEFRUIT_SPI_IRQ,
BLUEFRUIT_SPI_RST);
```

Make sure that the second line is uncommented (it should be)

OK now you can upload to the Bluefruit Feather!

If you're using Ubuntu 15.04 or other Linux distributions and run into errors attempting to upload a program to the board, scroll up to the Ubuntu and Linux issue fix in the previous section

Uploading to the Feather Bluefruit LE

It's pretty easy to upload, first up make sure you have Adafruit Feather 32u4 selected on the boards dropdown as above. Also, in the Ports menu, look for the port labeled as such:

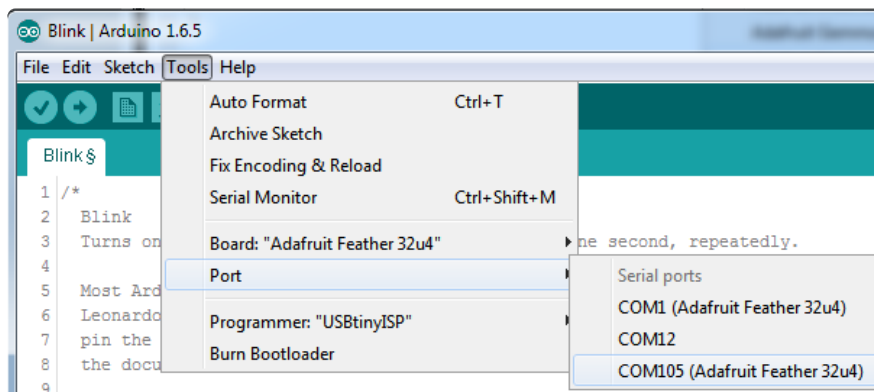

Now click the upload button on the Arduino IDE (or File Menu -> Upload)

If all is good you will see Done Uploading in the status bar

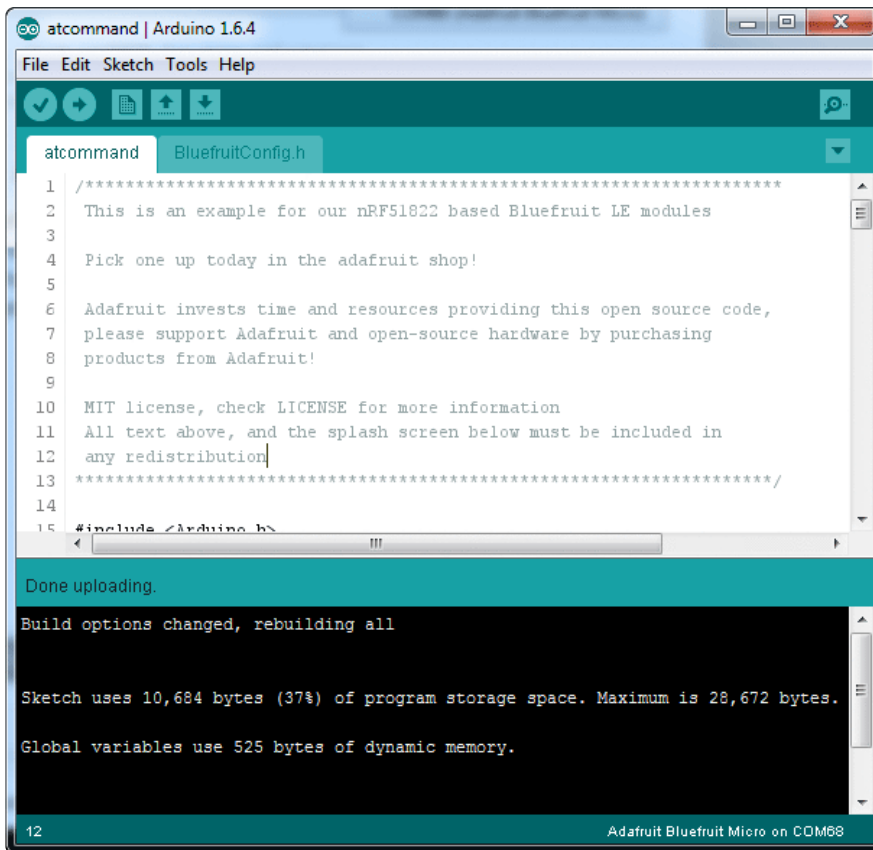

Uploading to a brand new board/Upload failures

If you are uploading for the first time to a new board, or if upload fails, press the RESET mini button on the Feather 32u4 Bluefruit when you see the Yellow Arrow lit and the Uploading... text in the status bar. When you see the red LED pulsing on and off, you know the bootloader is running.

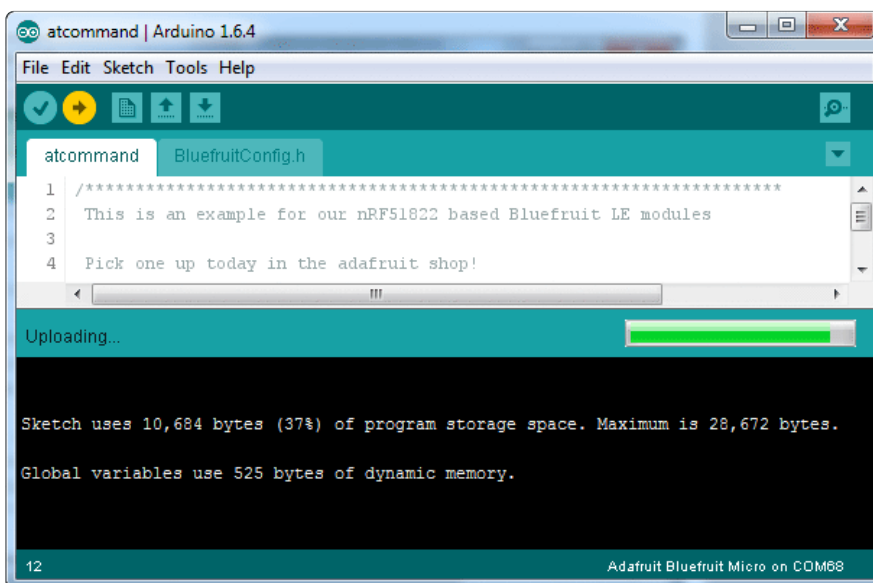

Don't click the reset button before uploading, unlike other bootloaders you want this one to run at the time Arduino is trying to upload

Run the sketch

OK check again that the correct port is selected

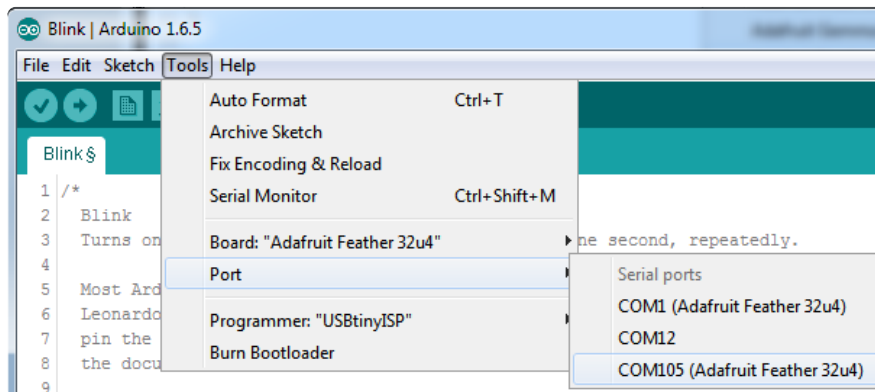

Then open up the Serial console. You will see the following:

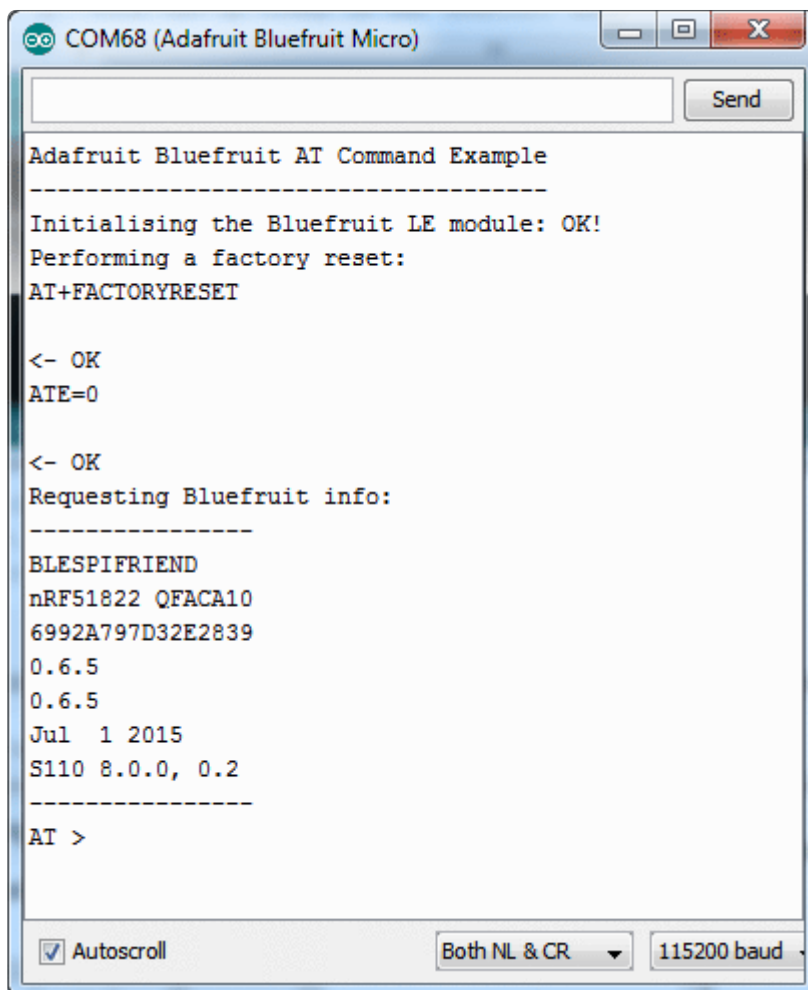

This sketch starts by doing a factory reset, then querying the BLE radio for details. These details will be useful if you are debugging the radio. If you see the information as above, you're working! (Note that the dates and version numbers may vary)

AT command testing

Now you can try out some AT commands - check the rest of the learn guide for a full list. We'll just start with AT+HWGETDIETEMP which will return the approximate ambient temperature of the BLE chipset

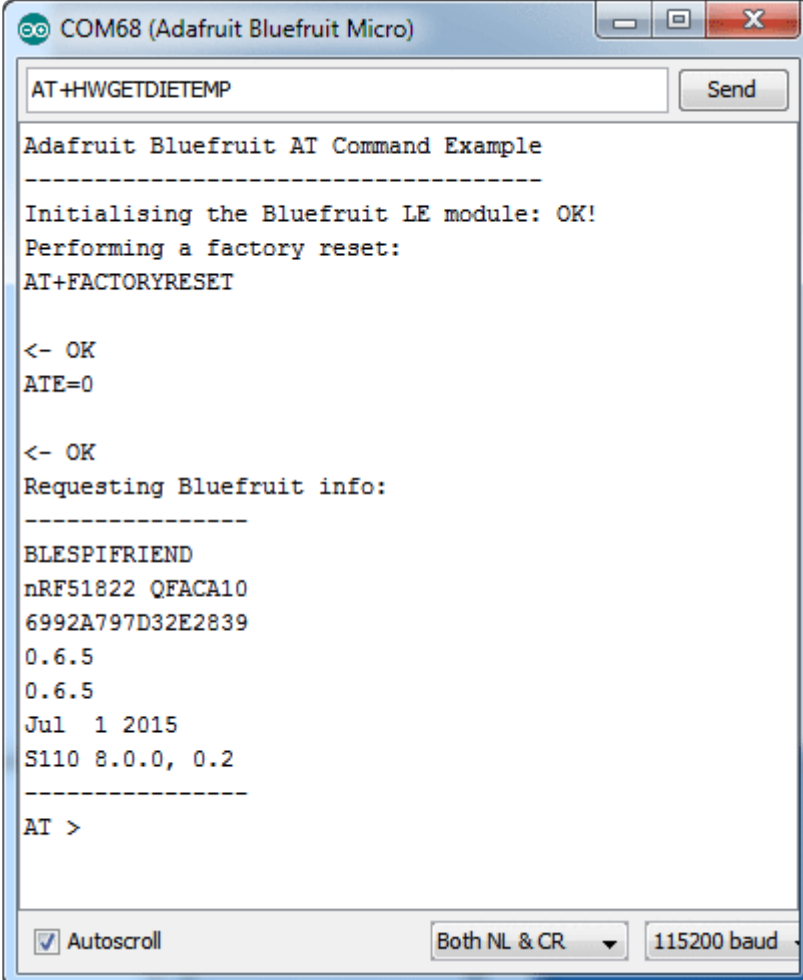

```
COM68 (Adafruit Bluefruit Micro)
AT+HWGETDIETEMP
Send
Adafruit Bluefruit AT Command Example
-----
Initialising the Bluefruit LE module: OK!
Performing a factory reset:
AT+FACTORYRESET
<- OK
ATE=0
<- OK
Requesting Bluefruit info:
-----
BLESPIFRIEND
nRF51822 QFACA10
6992A797D32E2839
0.6.5
0.6.5
Jul 1 2015
S110 8.0.0, 0.2
-----
AT >
```

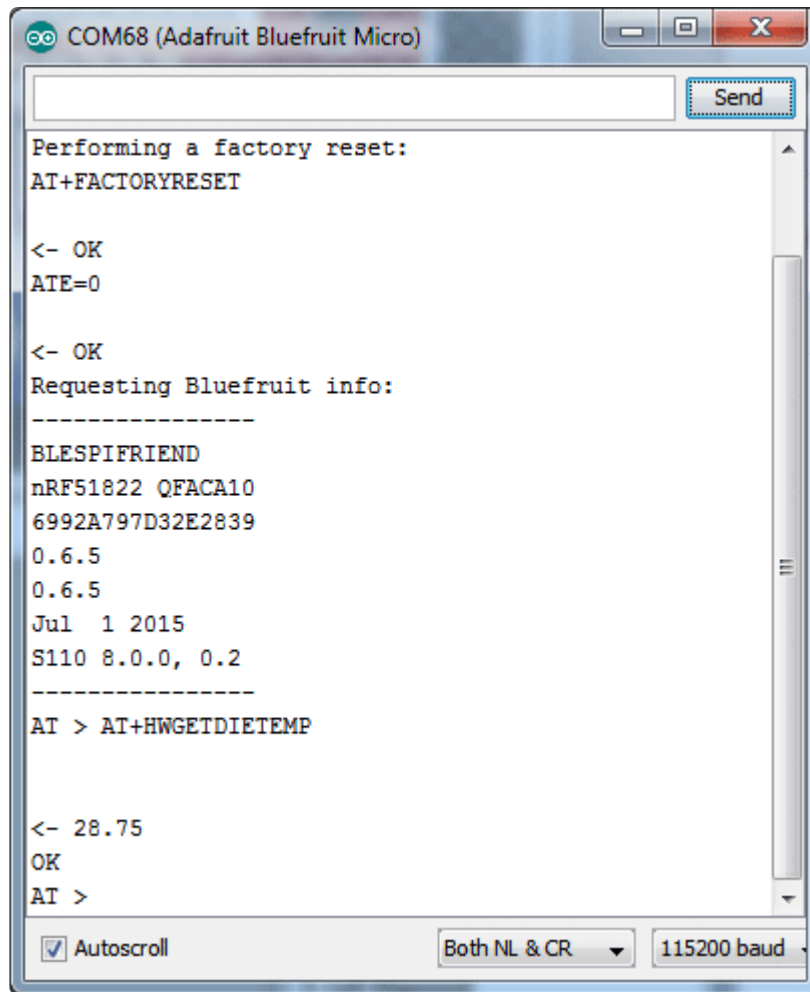

OK now you know how to upload/test/communicate with your Feather 32u4 Bluefruit. Next up we have a bunch of tutorials who can follow for checking out the bluetooth le radio and apps.

For all the following examples, we share the same code between various modules so don't forget to make sure you have the RESET pin set to 4 in BluefruitConfig.h for each sketch before uploading, and that Hardware SPI mode is selected by checking for

```
/* ...hardware SPI, using SCK/MOSI/MISO hardware SPI pins and then user
selected CS/IRQ/RST */
Adafruit_BluefruitLE_SPI ble(BLUEFRUIT_SPI_CS, BLUEFRUIT_SPI_IRQ,
BLUEFRUIT_SPI_RST);
```

Configuration!

Before you start uploading any of the example sketches, you'll need to CONFIGURE the Bluefruit interface - there's a lot of options so pay close attention!

Which board do you have?

There's a few products under the Bluefruit name:



If you are using the Bluefruit LE Shield then you have an SPI-connected NRF51822 module. You can use this with Atmega328 (Arduino UNO or compatible), ATmega32u4 (Arduino Leonardo, compatible) or ATSAM21 (Arduino Zero, compatible) and possibly others. Your pinouts are Hardware SPI, CS = 8, IRQ = 7, RST = 4

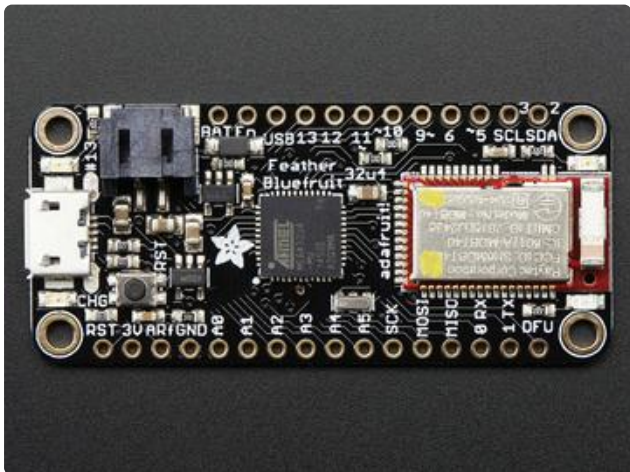

Bluefruit Micro or Feather 32u4 Bluefruit

If you have a Bluefruit Micro or Feather 32u4 Bluefruit LE then you have an ATmega32u4 chip with Hardware SPI, CS = 8, IRQ = 7, RST = 4

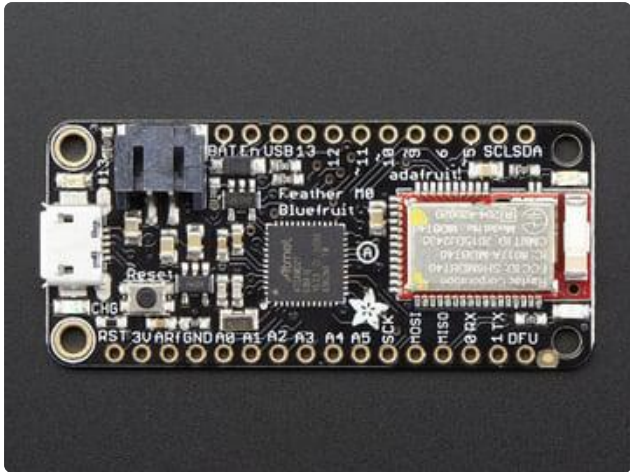

Feather M0 Bluefruit LE

If you have a Feather M0 Bluefruit LE then you have an ATSAMR21 chip with Hardware SPI, CS = 8, IRQ = 7, RST = 4

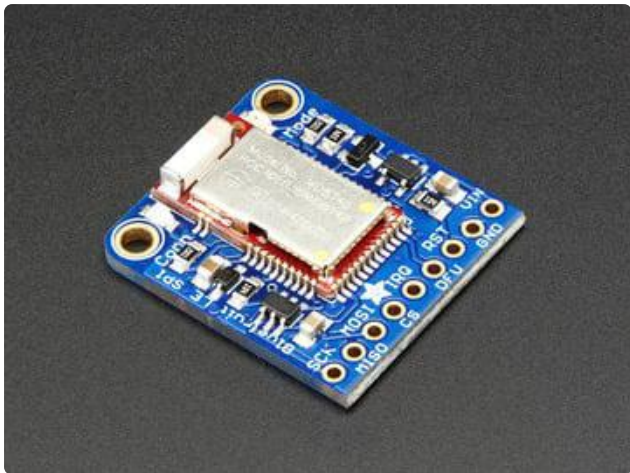

Bluefruit LE SPI Friend

If you have a stand-alone module, you have a bit of flexibility with wiring however we strongly recommend Hardware SPI, CS = 8, IRQ = 7, RST = 4

You can use this with just about any microcontroller with 5 or 6 pins

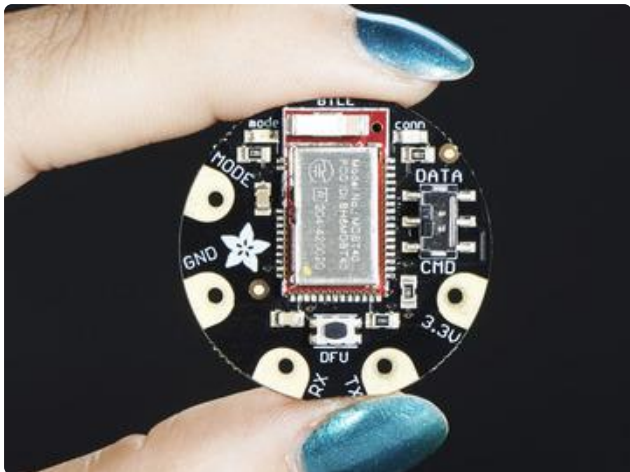
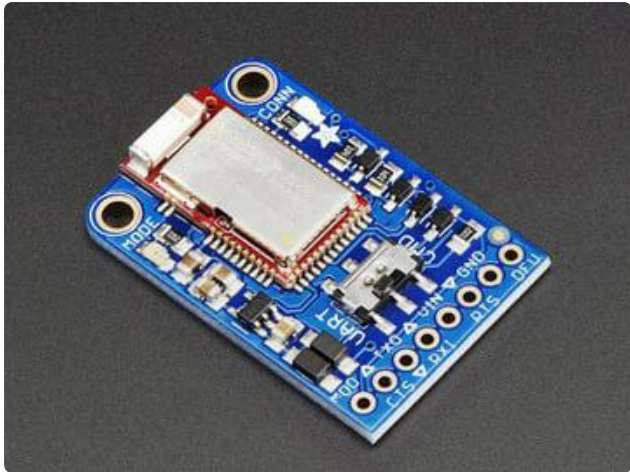

Bluefruit LE UART Friend or Flora BLE

If you have a stand-alone UART module you have some flexibility with wiring. However we suggest hardware UART if possible. You will likely need to use the flow control CTS pin if you are not using hardware UART. There's also a MODE pin

You can use this with just about any microcontroller with at least 3 pins, but best used with a Hardware Serial/UART capable chip!

Configure the Pins Used

You'll want to check the Bluefruit Config to set up the pins you'll be using for UART or SPI

Each example sketch has a secondary tab with configuration details. You'll want to edit and save the sketch to your own documents folder once set up.

```
atcommand | Arduino 1.6.4
File Edit Sketch Tools Help
atcommand BluefruitConfig.h
// COMMON SETTINGS
//
// These settings are used in both SW UART, HW UART and SPI mode
//
//-----
#define BUFSIZE 128 // Size of the read buffer for incoming data
#define VERBOSE_MODE true // If set to 'true' enables debug output

// SOFTWARE UART SETTINGS
//
// The following macros declare the pins that will be used for 'SW' serial.
// You should use this option if you are connecting the UART Friend to an UNO
//
//-----
#define BLUEFRUIT_SWUART_RXD_PIN 9 // Required for software serial!
```

Common settings:

You can set up how much RAM to set aside for a communication buffer and whether you want to have full debug output. Debug output is 'noisy' on the serial console but is handy since you can see all communication between the micro and the BLE

```
//
-----
// These settings are used in both SW UART, HW UART and SPI mode
//
-----
#define BUFSIZE 128 // Size of the read buffer for
incoming data
#define VERBOSE_MODE true // If set to 'true' enables debug
output
```

Software UART

If you are using Software UART, you can set up which pins are going to be used for RX, TX, and CTS flow control. Some microcontrollers are limited on which pins can be used! Check the SoftwareSerial library documentation for more details

```
// SOFTWARE UART SETTINGS
#define BLUEFRUIT_SWUART_RXD_PIN 9 // Required for software serial!
#define BLUEFRUIT_SWUART_TXD_PIN 10 // Required for software serial!
#define BLUEFRUIT_UART_CTS_PIN 11 // Required for software serial!
#define BLUEFRUIT_UART_RTS_PIN -1 // Optional, set to -1 if unused
```

Hardware UART

If you have Hardware Serial, there's a 'name' for it, usually Serial1 - you can set that up here:

```
// HARDWARE UART SETTINGS
#ifdef Serial1 // this makes it not complain on compilation if there's no Serial1
#define BLUEFRUIT_HWSERIAL_NAME Serial1
#endif
```

Mode Pin

For both hardware and software serial, you will likely want to define the MODE pin. There's a few sketches that don't use it, instead depending on commands to set/unset the mode. It's best to use the MODE pin if you have a GPIO to spare!

```
#define BLUEFRUIT_UART_MODE_PIN      12    // Set to -1 if unused
```

SPI Pins

For both Hardware and Software SPI, you'll want to set the CS (chip select) line, IRQ (interrupt request) line and if you have a pin to spare, RST (Reset)

```
// SHARED SPI SETTINGS
#define BLUEFRUIT_SPI_CS              8
#define BLUEFRUIT_SPI_IRQ             7
#define BLUEFRUIT_SPI_RST             4    // Optional but recommended, set to -1
if unused
```

Software SPI Pins

If you don't have a hardware SPI port available, you can use any three pins...its a tad slower but very flexible

```
// SOFTWARE SPI SETTINGS
#define BLUEFRUIT_SPI_SCK             13
#define BLUEFRUIT_SPI_MISO           12
#define BLUEFRUIT_SPI_MOSI           11
```

Refer to the table above to determine whether you have SPI or UART controlled Bluefruits!

Select the Serial Bus

Once you've configured your pin setup in the BluefruitConfig.h file, you can now check and adapt the example sketch.

The Adafruit_BluefruitLE_nRF51 library supports four different serial bus options, depending on the HW you are using: SPI both hardware and software type, and UART both hardware and software type.

UART Based Boards (Bluefruit LE UART Friend & Flora BLE)

This is for Bluefruit LE UART Friend & Flora BLE boards. You can use either software serial or hardware serial. Hardware serial is higher quality, and less risky with respect

to losing data. However, you may not have hardware serial available! Software serial does work just fine with flow-control and we do have that available at the cost of a single GPIO pin.

For software serial (Arduino Uno, Adafruit Metro) you should uncomment the software serial constructor below, and make sure the other three options (hardware serial & SPI) are commented out.

```
// Create the bluefruit object, either software serial...uncomment these lines
SoftwareSerial bluefruitSS = SoftwareSerial(BLUEFRUIT_SWUART_TXD_PIN,
BLUEFRUIT_SWUART_RXD_PIN);

Adafruit_BluefruitLE_UART ble(bluefruitSS, BLUEFRUIT_UART_MODE_PIN,
BLUEFRUIT_UART_CTS_PIN, BLUEFRUIT_UART_RTS_PIN);
```

For boards that require hardware serial (Adafruit Flora, etc.), uncomment the hardware serial constructor, and make sure the other three options are commented out

```
/* ...or hardware serial, which does not need the RTS/CTS pins. Uncomment this line
*/
Adafruit_BluefruitLE_UART ble(BLUEFRUIT_HWSERIAL_NAME, BLUEFRUIT_UART_MODE_PIN);
```

SPI Based Boards (Bluefruit LE SPI Friend)

For SPI based boards, you should uncomment the hardware SPI constructor below, making sure the other constructors are commented out:

```
/* ...hardware SPI, using SCK/MOSI/MISO hardware SPI pins and then user selected CS/
IRQ/RST */
Adafruit_BluefruitLE_SPI ble(BLUEFRUIT_SPI_CS, BLUEFRUIT_SPI_IRQ,
BLUEFRUIT_SPI_RST);
```

If for some reason you can't use HW SPI, you can switch to software mode to bit-bang the SPI transfers via the following constructor:

```
/* ...software SPI, using SCK/MOSI/MISO user-defined SPI pins and then user
selected CS/IRQ/RST */
Adafruit_BluefruitLE_SPI ble(BLUEFRUIT_SPI_SCK, BLUEFRUIT_SPI_MISO,
BLUEFRUIT_SPI_MOSI, BLUEFRUIT_SPI_CS,
BLUEFRUIT_SPI_IRQ, BLUEFRUIT_SPI_RST);
```

BLEUart

The BLEUart example sketch allows you to send and receive text data between the Arduino and a connected Bluetooth Low Energy Central device on the other end (such as your mobile phone using the Adafruit Bluefruit LE Connect application for [Android](https://adafru.it/f4G) or [iOS](https://adafru.it/f4H) in UART mode).

Opening the Sketch

To open the ATCommand sketch, click on the File > Examples > Adafruit_BluefruitLE_nRF51 folder in the Arduino IDE and select `bleuart_cmdmode`:

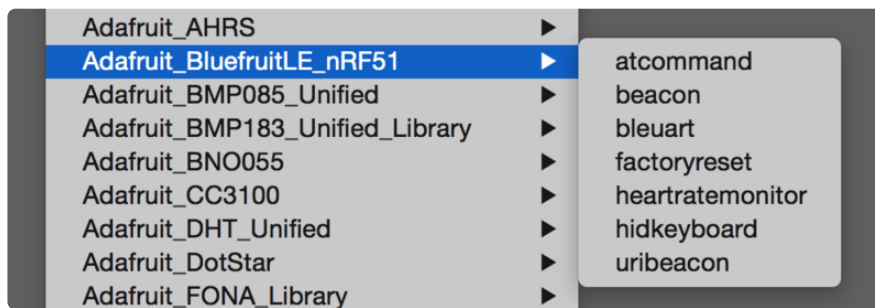

This will open up a new instance of the example in the IDE, as shown below:



Configuration

Check the Configuration! page earlier to set up the sketch for Software/Hardware UART or Software/Hardware SPI. The default is hardware SPI

If using software or hardware Serial UART:

- This tutorial does not need to use the MODE pin, make sure you have the mode switch in CMD mode if you do not configure & connect a MODE pin
- Don't forget to also connect the CTS pin on the Bluefruit to ground if you are not using it! (The Flora has this already done)

Running the Sketch

Once you upload the sketch to your board (via the arrow-shaped upload icon), and the upload process has finished, open up the Serial Monitor via Tools > Serial Monitor, and make sure that the baud rate in the lower right-hand corner is set to 115200:

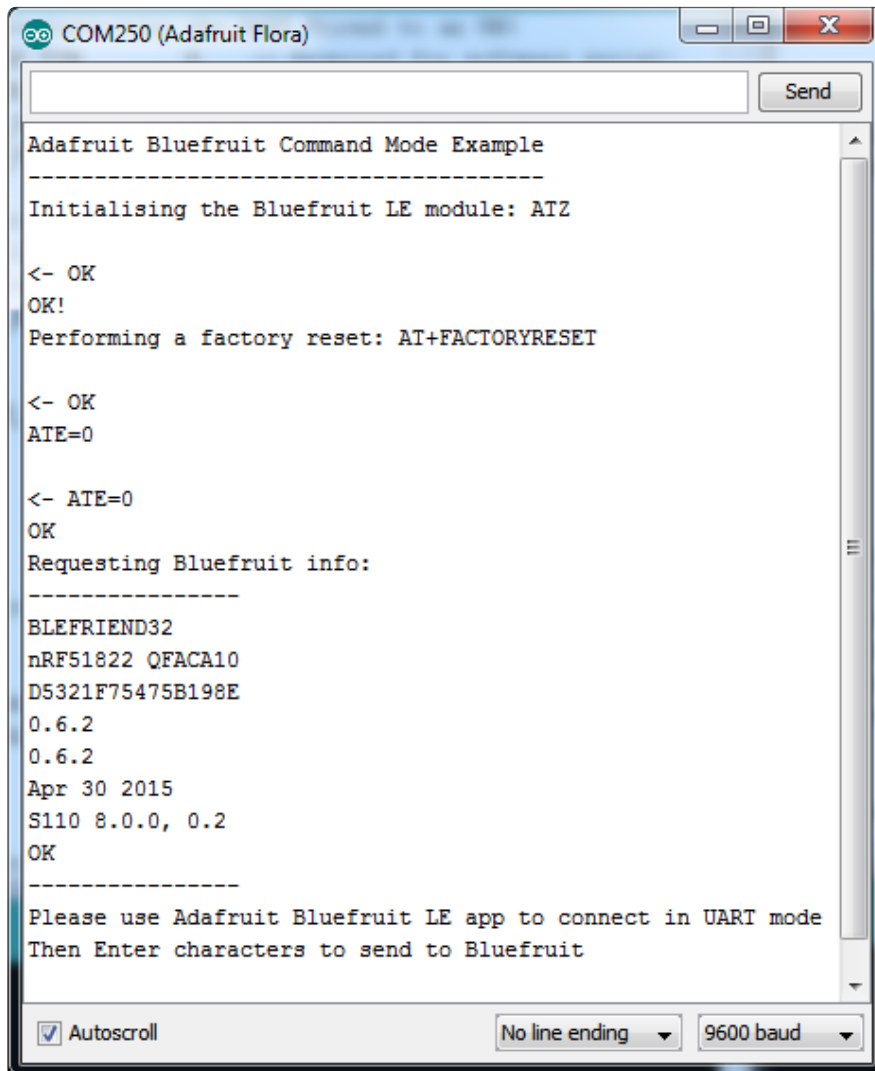

Once you see the request, use the App to connect to the Bluefruit LE module in UART mode so you get the text box on your phone

Any text that you type in the box at the top of the Serial Monitor will be sent to the connected phone, and any data sent from the phone will be displayed in the serial monitor:

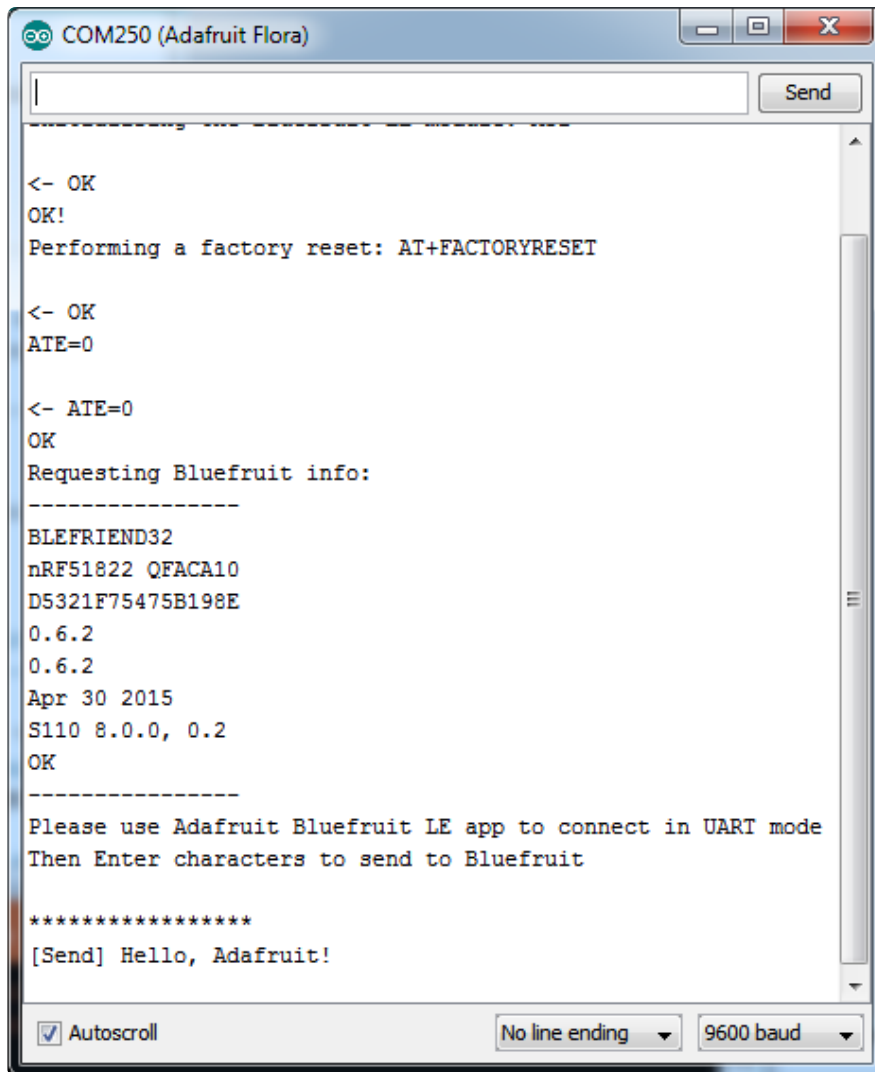

You can see the incoming string here in the Adafruit Bluefruit LE Connect app below (iOS in this case):

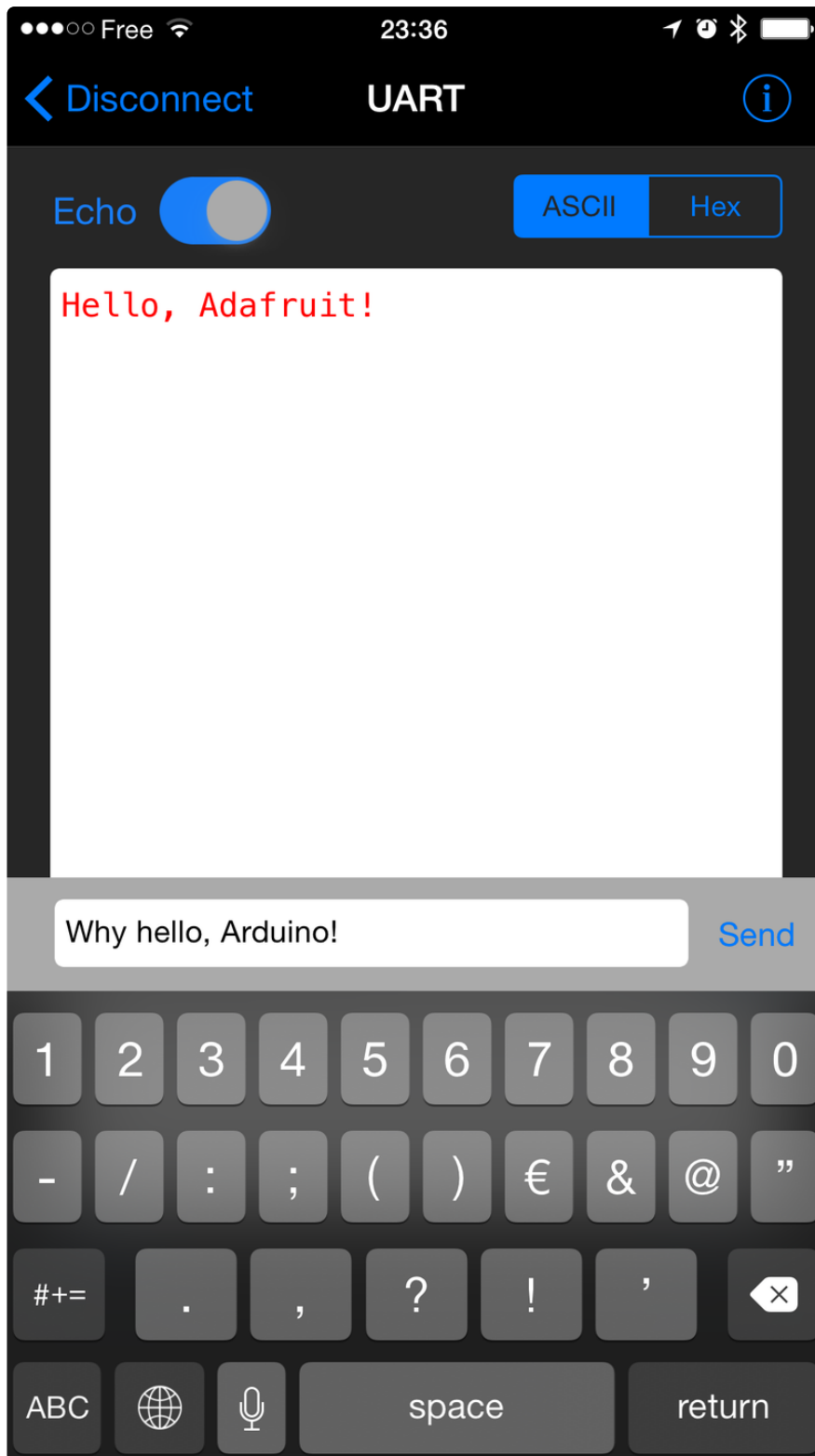

The response text ('Why hello, Arduino!') can be seen below:

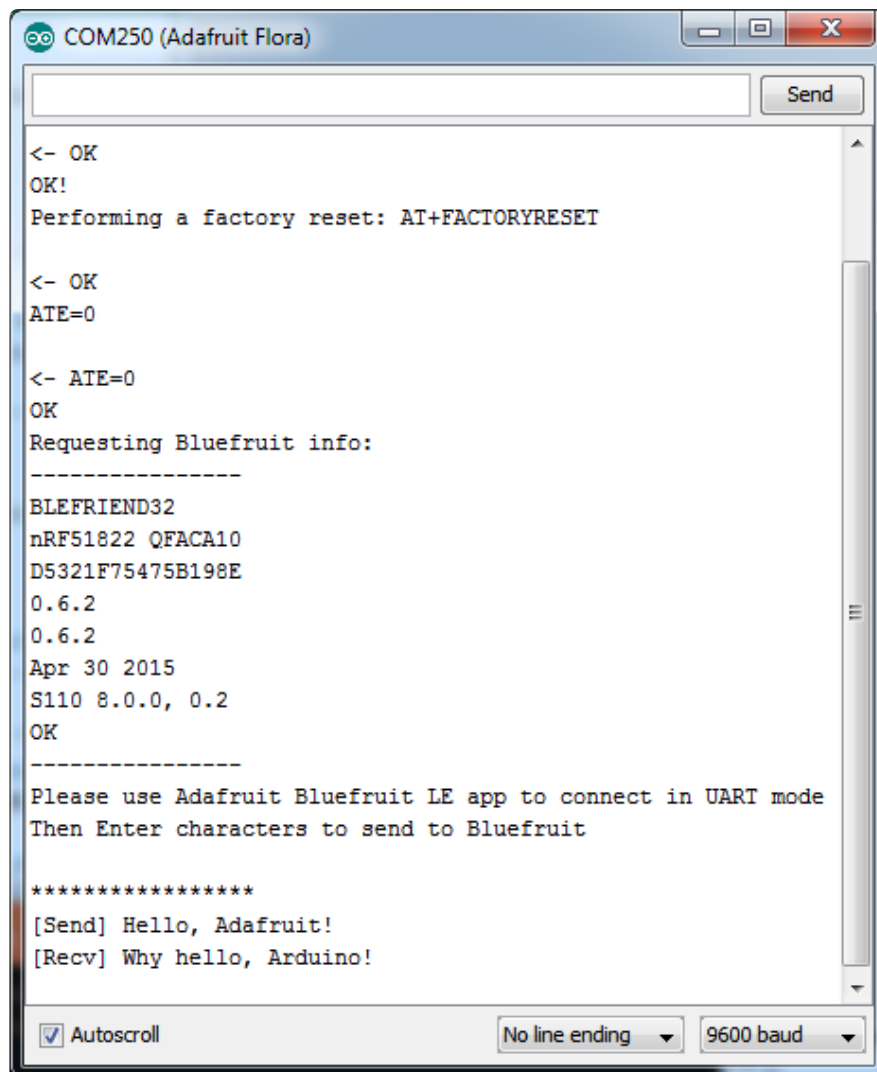

HIDKeyboard

The HIDKeyboard example shows you how you can use the built-in HID keyboard AT commands to send keyboard data to any BLE-enabled Android or iOS phone, or other device that supports BLE HID peripherals.

Opening the Sketch

To open the ATCommand sketch, click on the File > Examples > Adafruit_BluefruitLE_nRF51 folder in the Arduino IDE and select hidkeyboard:

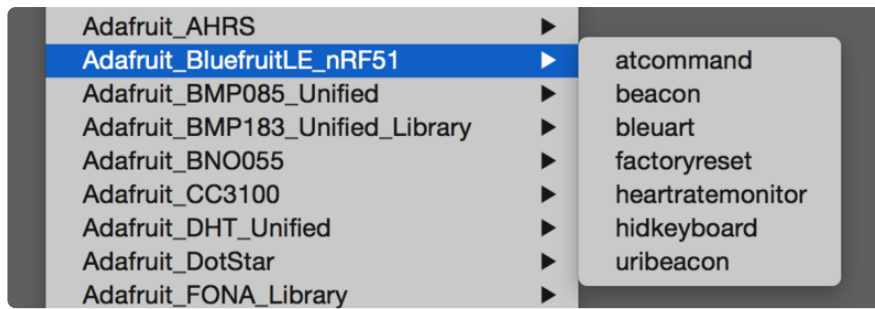

This will open up a new instance of the example in the IDE, as shown below:

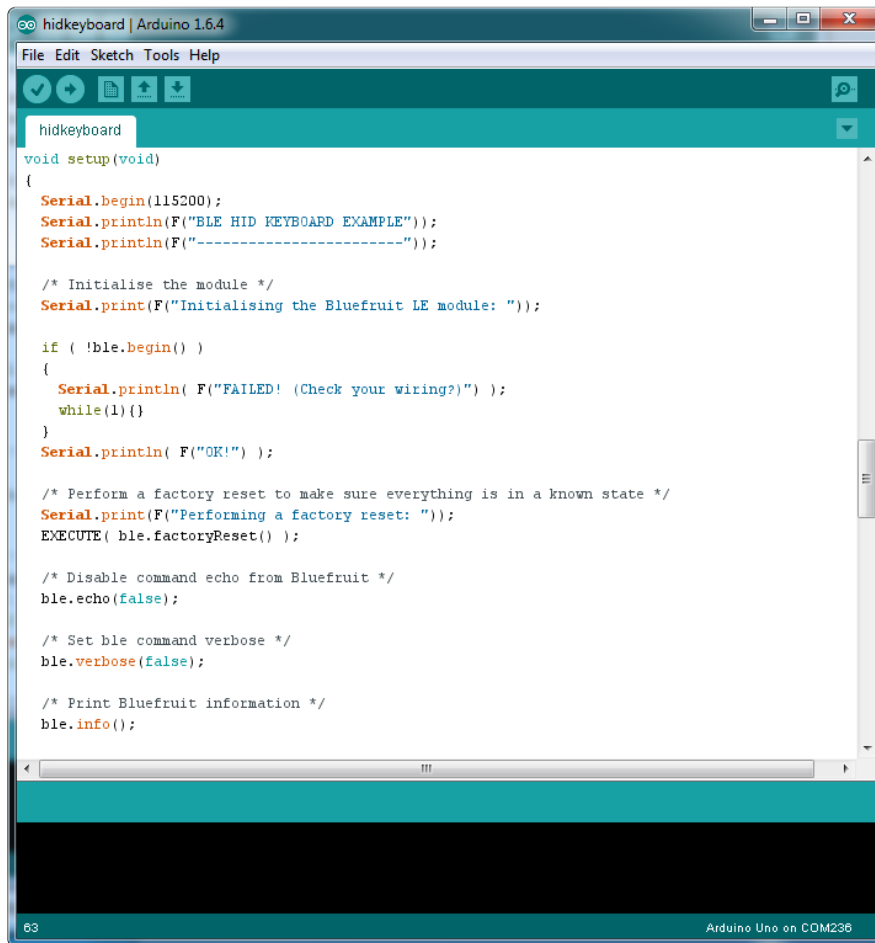

Configuration

Check the Configuration! page earlier to set up the sketch for Software/Hardware UART or Software/Hardware SPI. The default is hardware SPI

If using software or hardware Serial UART:

- This tutorial does not need to use the MODE pin, make sure you have the mode switch in CMD mode!

- Don't forget to also connect the CTS pin on the Bluefruit to ground if you are not using it! (The Flora has this already done)

Running the Sketch

Once you upload the sketch to your board (via the arrow-shaped upload icon), and the upload process has finished, open up the Serial Monitor via Tools > Serial Monitor, and make sure that the baud rate in the lower right-hand corner is set to 115200:

```
COM250 (Adafruit Flora)
|
| Send
|
Adafruit Bluefruit HID Keyboard Example
-----
Initialising the Bluefruit LE module:
ATZ

<- OK
OK!
Performing a factory reset:
AT+FACTORYRESET

<- OK
ATE=0

<- ATE=0
OK
Requesting Bluefruit info:
-----
BLEFRIEND32
nRF51822 QFACA10
D5321F75475B198E
0.6.2
0.6.2
Apr 30 2015
S110 8.0.0, 0.2
OK
-----
Setting device name to 'Bluefruit Keyboard':
AT+GAPDEVNAME=Bluefruit Keyboard

<- OK
Enable Keyboard Service:
AT+BleKeyboardEn=On

<- OK
Performing a SW reset (service changes require a reset):
ATZ

<- OK

Go to your phone's Bluetooth settings to pair your device
then open an application that accepts keyboard input

Enter the character(s) to send:
- \r for Enter
- \n for newline
- \t for tab
- \b for backspace

keyboard >

 Autoscroll   No line ending   115200 baud
```

To send keyboard data, type anything into the textbox at the top of the Serial Monitor and click the Send button.

Bonding the HID Keyboard

Before you can use the HID keyboard, you will need to 'bond' it to your phone or PC. The bonding process establishes a permanent connection between the two devices, meaning that as soon as your phone or PC sees the Bluefruit LE module again it will automatically connect.

The exact procedures for bonding the keyboard will vary from one platform to another.

When you no longer need a bond, or wish to bond the Bluefruit LE module to another device, be sure to delete the bonding information on the phone or PC, otherwise you may not be able to connect on a new device!

Android

To bond the keyboard on a Bluetooth Low Energy enabled Android device, go to the Settings application and click the Bluetooth icon.

These screenshots are based on Android 5.0 running on a Nexus 7 2013. The exact appearance may vary depending on your device and OS version.

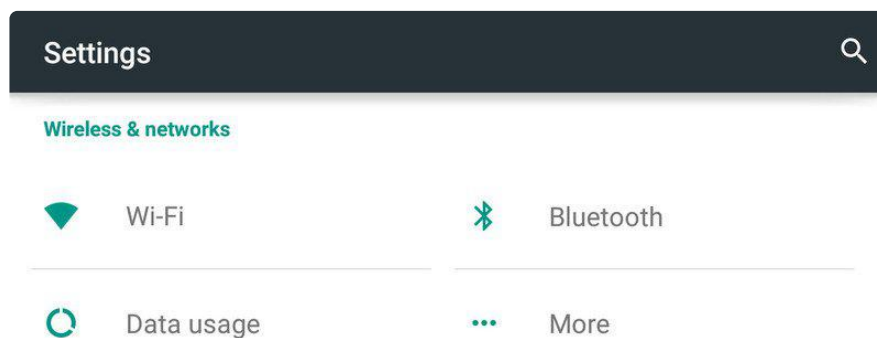

Inside the Bluetooth setting panel you should see the Bluefruit LE module advertising itself as Bluefruit Keyboard under the 'Available devices' list:

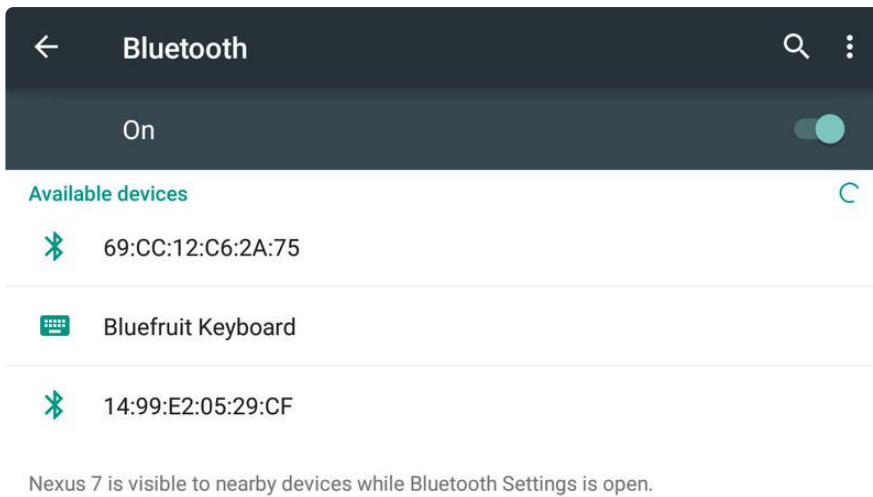

Tapping the device will start the bonding process, which should end with the Bluefruit Keyboard device being moved to a new 'Paired devices' list with 'Connected' written underneath the device name:



To delete the bonding information, click the gear icon to the right of the device name and then click the Forget button:

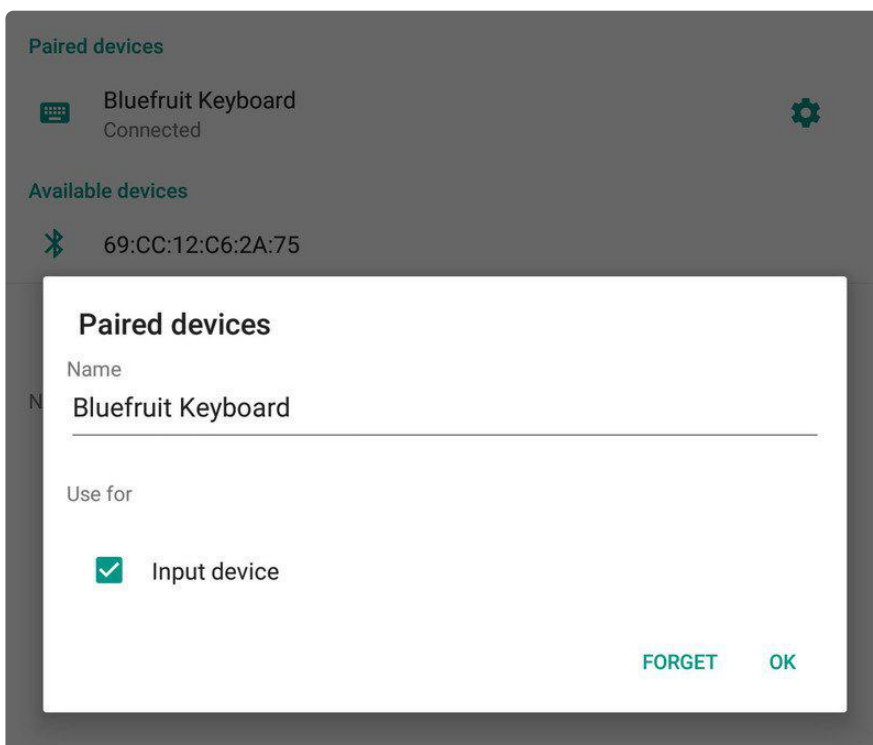

iOS

To bond the keyboard on an iOS device, go to the Settings application on your phone, and click the Bluetooth menu item.

The keyboard should appear under the OTHER DEVICES list:

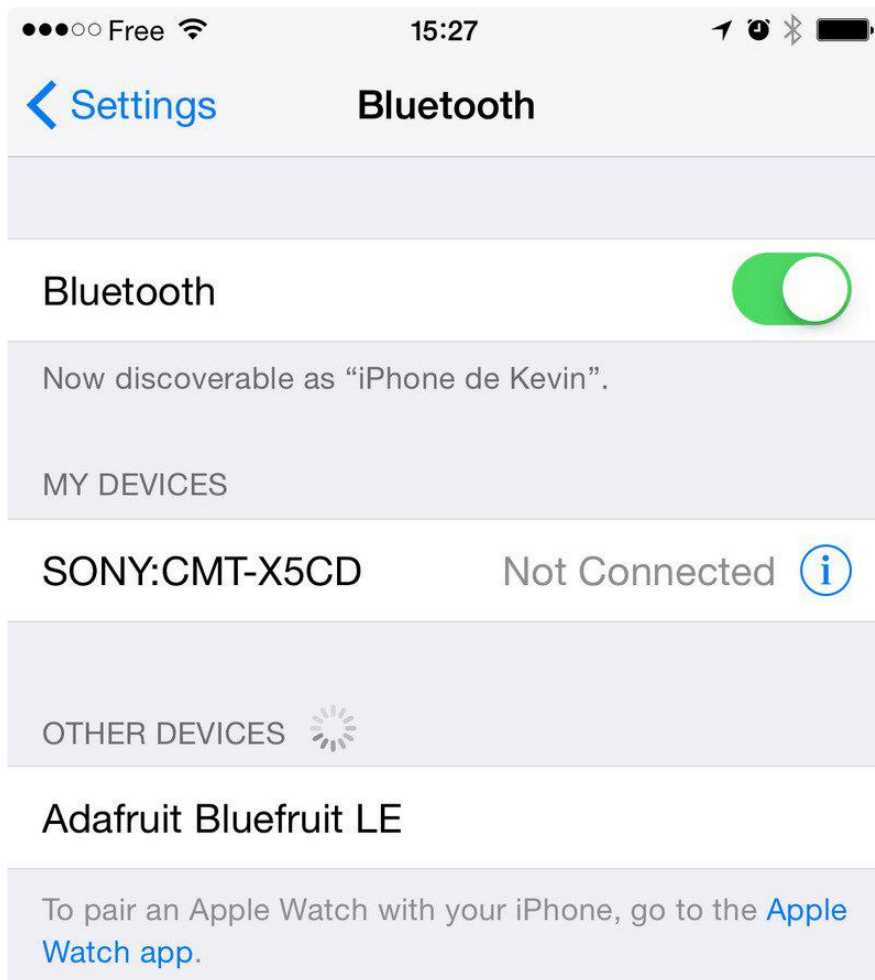

Once the bonding process is complete the device will be moved to the MY DEVICES category, and you can start to use the Bluefruit LE module as a keyboard:

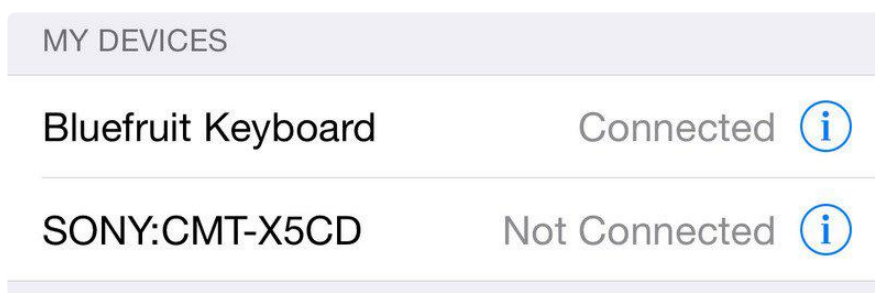

To unbond the device, click the 'info' icon and then select the Forget this Device option in the menu:

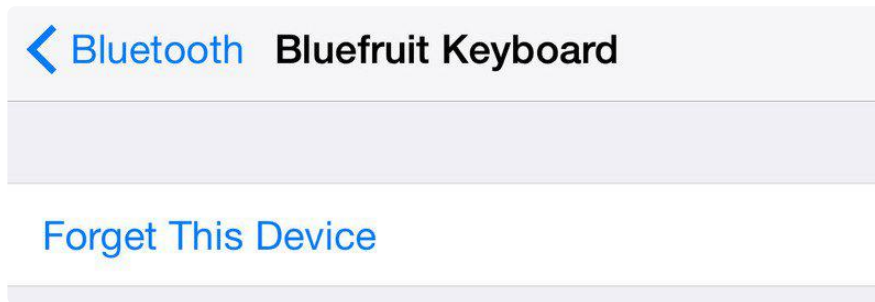

OS X

To bond the keyboard on an OS X device, go to the Bluetooth Preferences window and click the Pair button beside the Bluefruit Keyboard device generated by this example sketch:

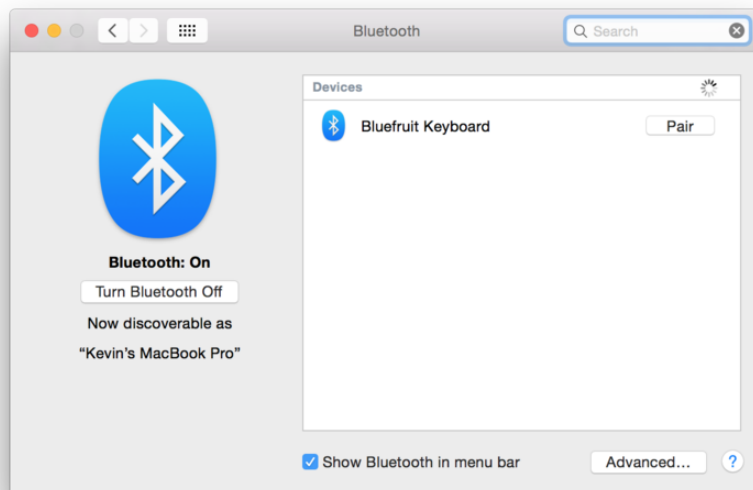

To unbond the device once it has been paired, click the small 'x' icon beside Bluefruit Keyboard:

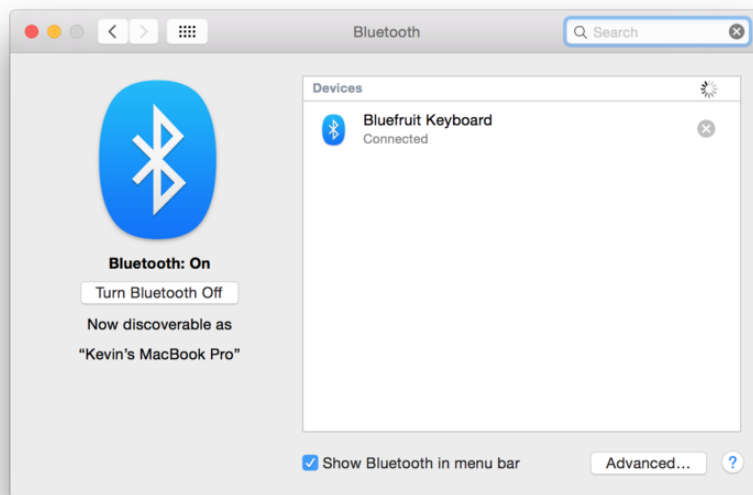

... and then click the Remove button when the confirmation dialogue box pops up:

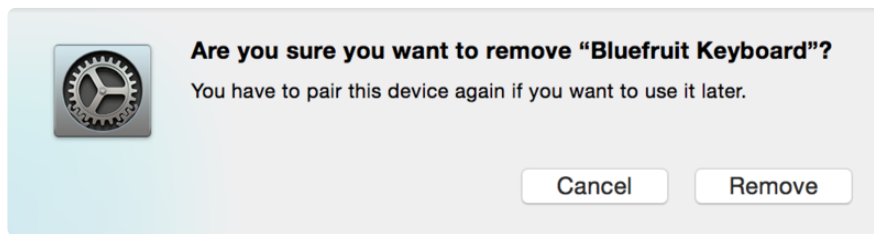

Controller

The Controller sketch allows you to turn your BLE-enabled iOS or Android device in a hand-held controller or an external data source, taking advantage of the wealth of sensors on your phone or tablet.

You can take accelerometer or quaternion data from your phone, and push it out to your Arduino via BLE, or get the latest GPS co-ordinates for your device without having to purchase (or power!) any external HW.

Opening the Sketch

To open the Controller sketch, click on the File > Examples > Adafruit_BluefruitLE_nRF51 folder in the Arduino IDE and select controller:

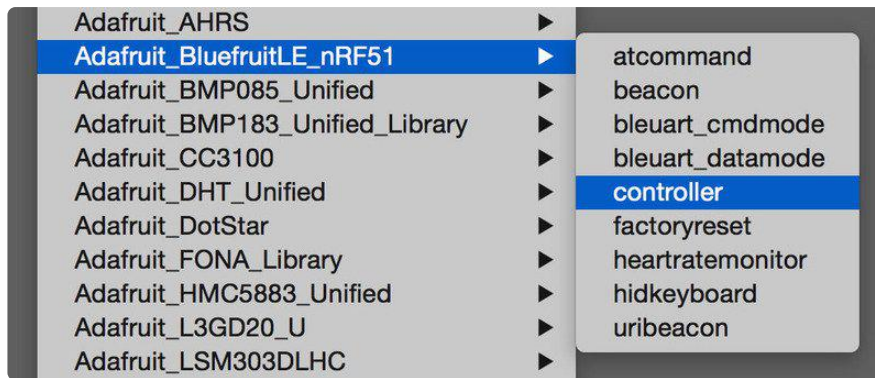

This will open up a new instance of the example in the IDE, as shown below:

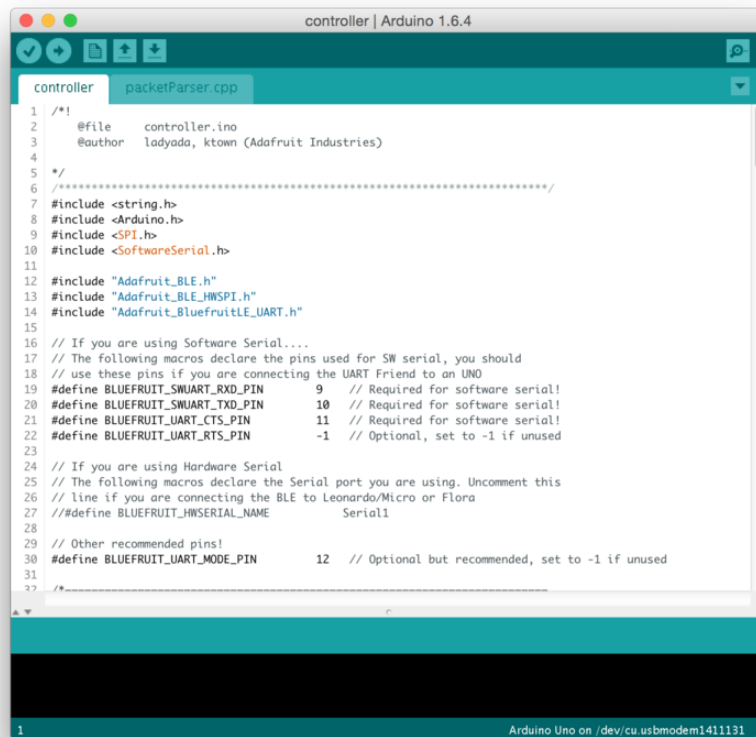

Configuration

Check the Configuration! page earlier to set up the sketch for Software/Hardware UART or Software/Hardware SPI. The default is hardware SPI

If using software or hardware Serial UART:

- This tutorial will also be easier to use if you wire up the MODE pin, you can use any pin but our tutorial has pin 12 by default. You can change this to any pin. If

you do not set the MODE pin then make sure you have the mode switch in CMD mode

- If you are using a Flora or otherwise don't want to wire up the Mode pin, set the BLUEFRUIT_UART_MODE_PIN to -1 in the configuration tab so that the sketch will use the +++ method to switch between Command and Data mode!
- Don't forget to also connect the CTS pin on the Bluefruit to ground if you are not using it! (The Flora has this already done)

Running the Sketch

Once you upload the sketch to your board (via the arrow-shaped upload icon), and the upload process has finished, open up the Serial Monitor via Tools > Serial Monitor, and make sure that the baud rate in the lower right-hand corner is set to 115200:

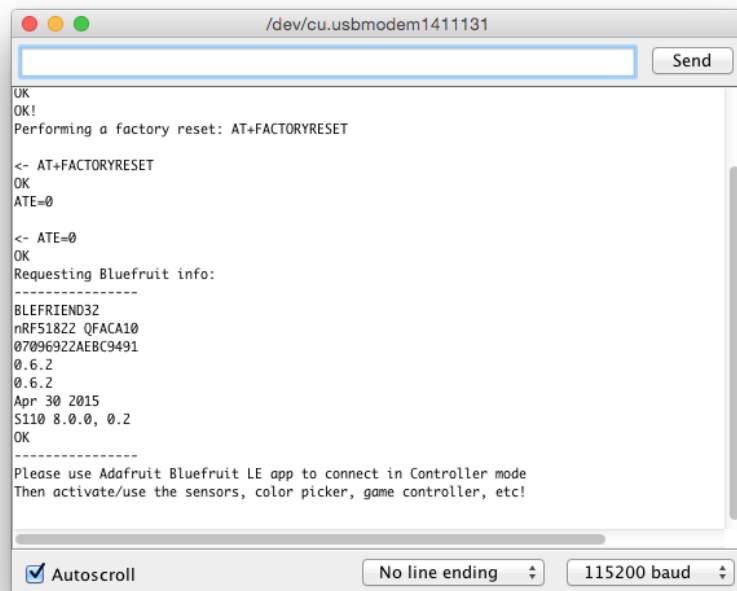

```
OK
OK!
Performing a factory reset: AT+FACTORYRESET

<- AT+FACTORYRESET
OK
ATE=0

<- ATE=0
OK
Requesting Bluefruit info:
-----
BLEFRIEND32
nRF51822 QFACA10
07096922AEBC9491
0.6.2
0.6.2
Apr 30 2015
S110 8.0.0, 0.2
OK
-----

Please use Adafruit Bluefruit LE app to connect in Controller mode
Then activate/use the sensors, color picker, game controller, etc!
```

Using Bluefruit LE Connect in Controller Mode

Once the sketch is running you can open Adafruit's Bluefruit LE Connect application (available for [Android \(https://adafru.it/f4G\)](https://adafru.it/f4G) or [iOS \(https://adafru.it/f4H\)](https://adafru.it/f4H)) and use the Controller application to interact with the sketch. (If you're new to Bluefruit LE Connect, have a look at our [dedicated Bluefruit LE Connect learning guide \(https://adafru.it/iCm\)](https://adafru.it/iCm).)

On the welcome screen, select the Adafruit Bluefruit LE device from the list of BLE devices in range:



Then from the activity list select Controller:

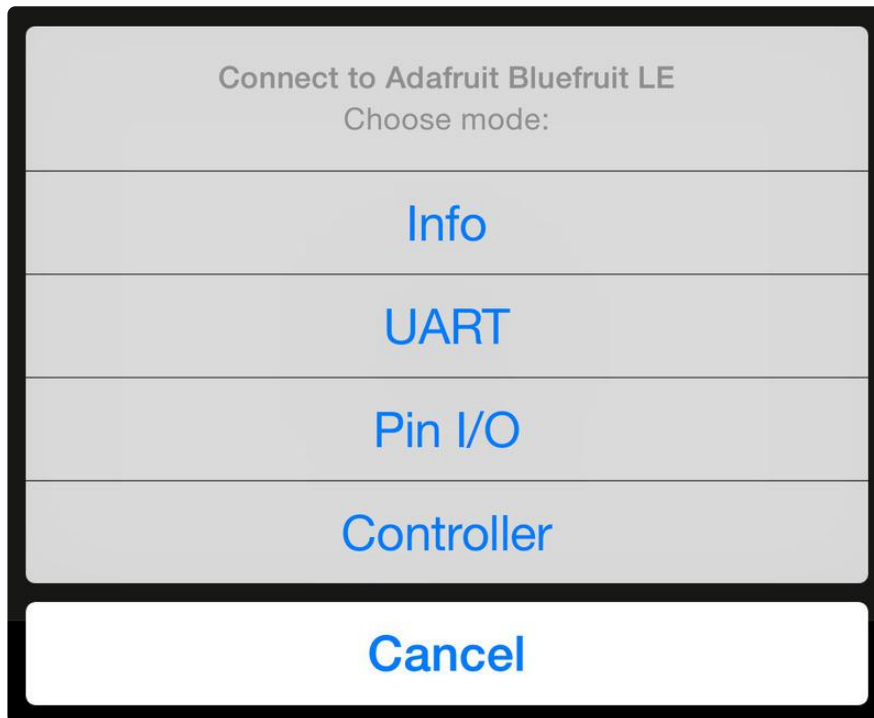

This will bring up a list of data points you can send from your phone or tablet to your Bluefruit LE module, by enabling or disabling the appropriate sensor(s).

Streaming Sensor Data

You can take Quaternion (absolute orientation), Accelerometer, Gyroscope, Magnetometer or GPS Location data from your phone and send it directly to your Arduino from the Controller activity.

By enabling the Accelerometer field, for example, you should see accelerometer data update in the app:

STREAM SENSOR DATA

Quaternion

Accelerometer

x: 0.15683

y: -0.580338

z: -0.794373

Gyro

Magnetometer

Location

The data is parsed in the example sketch and output to the Serial Monitor as follows:

```

Accel  0.20-0.51  -0.76
Accel  0.22-0.50  -0.83
Accel  0.25-0.51  -0.83
Accel  0.21-0.47  -0.76
Accel  0.27-0.48  -0.82

```

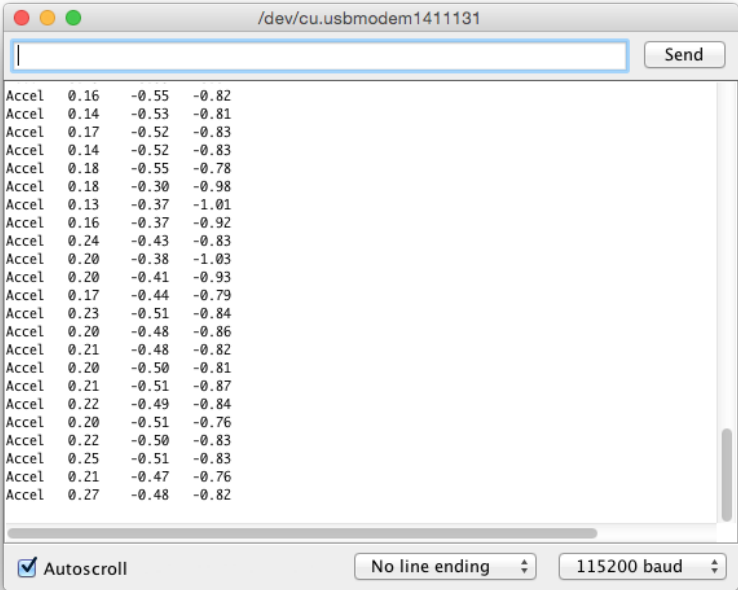

Note that even though we only print 2 decimal points, the values are received from the App as a full 4-byte floating point.

Control Pad Module

You can also use the Control Pad Module to capture button presses and releases by selecting the appropriate menu item:

Control Pad >

This will bring up the Control Pad panel, shown below:

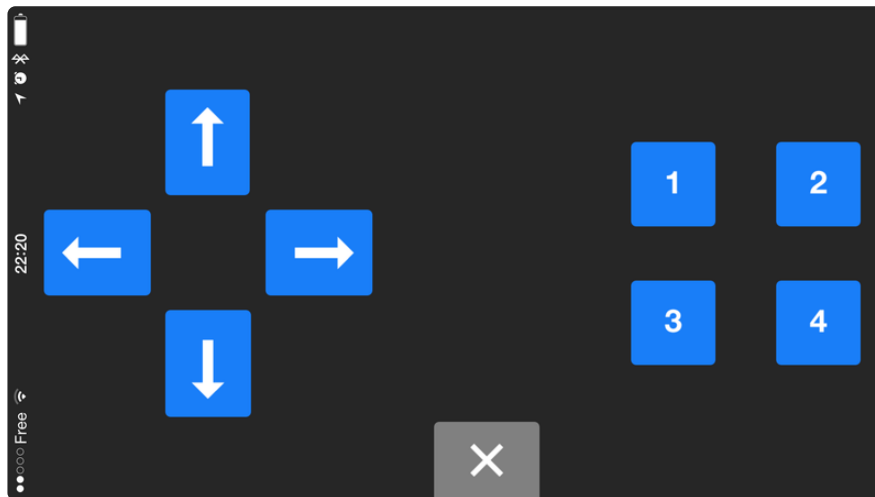

Button presses and releases will all be logged to the Serial Monitor with the ID of the button used:

```
Button 8 pressed  
Button 8 released  
Button 3 pressed  
Button 3 released
```

Color Picker Module

You can also send RGB color data via the Color Picker module, which presents the following color selection dialogue:

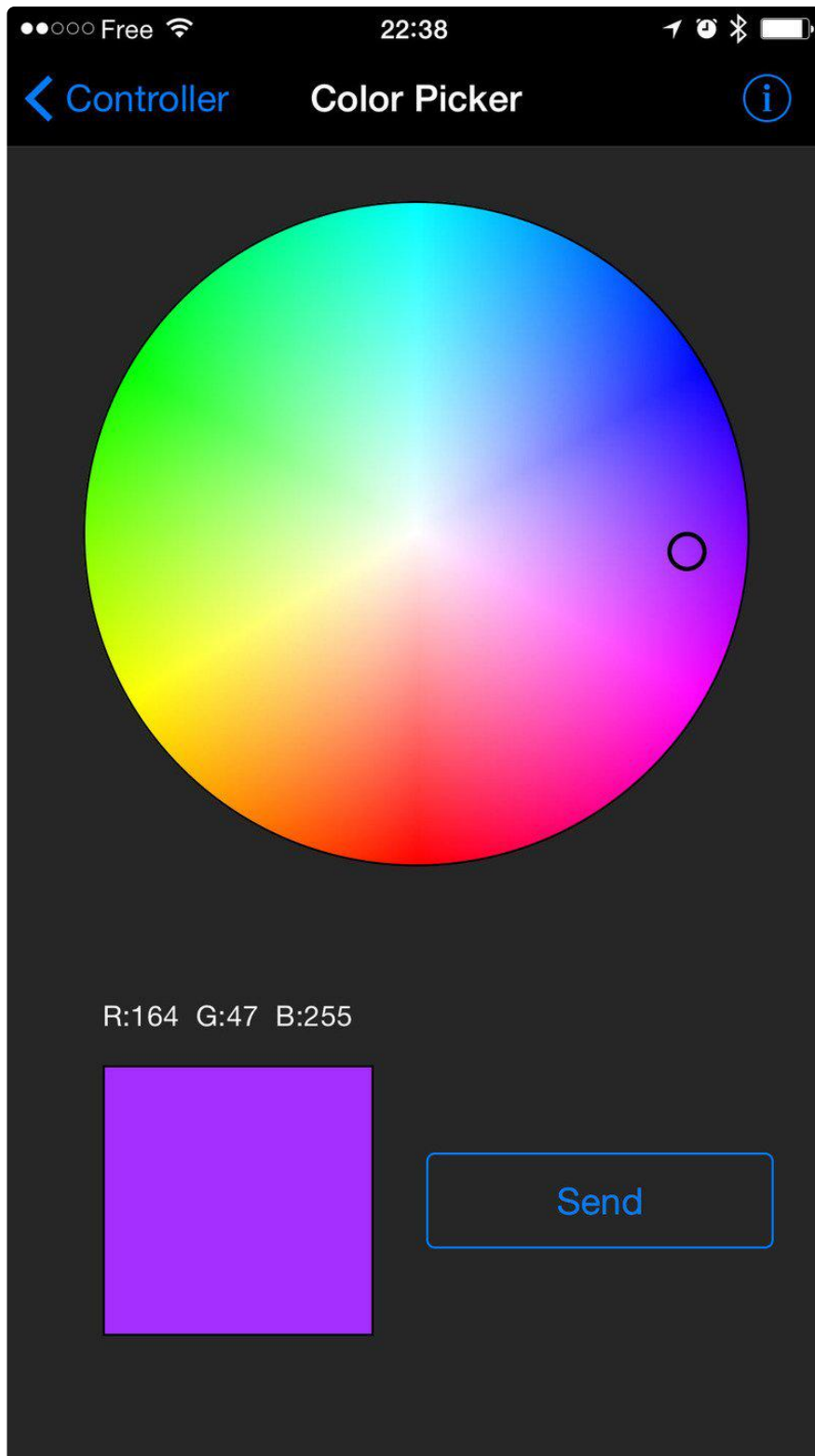

This will give you Hexadecimal color data in the following format:

```
RGB #A42FFF
```

You can combine the color picker and controller sample sketches to make color-configurable animations triggered by buttons in the mobile app-- very handy for

wearables! Download this combined sample code (configured for Feather but easy to adapt to FLORA, BLE Micro, etc.) to get started:

feather_bluefruit_neopixel_animation_

<https://adafru.it/kzF>

HeartRateMonitor

The HeartRateMonitor example allows you to define a new GATT Service and associated GATT Characteristics, and update the characteristic values using standard AT commands.

Opening the Sketch

To open the ATCommand sketch, click on the File > Examples > Adafruit_BluefruitLE_nRF51 folder in the Arduino IDE and select heartratemonitor:

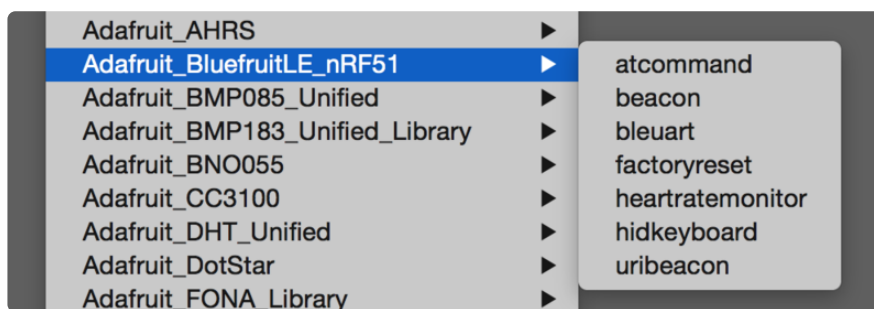

This will open up a new instance of the example in the IDE, as shown below:

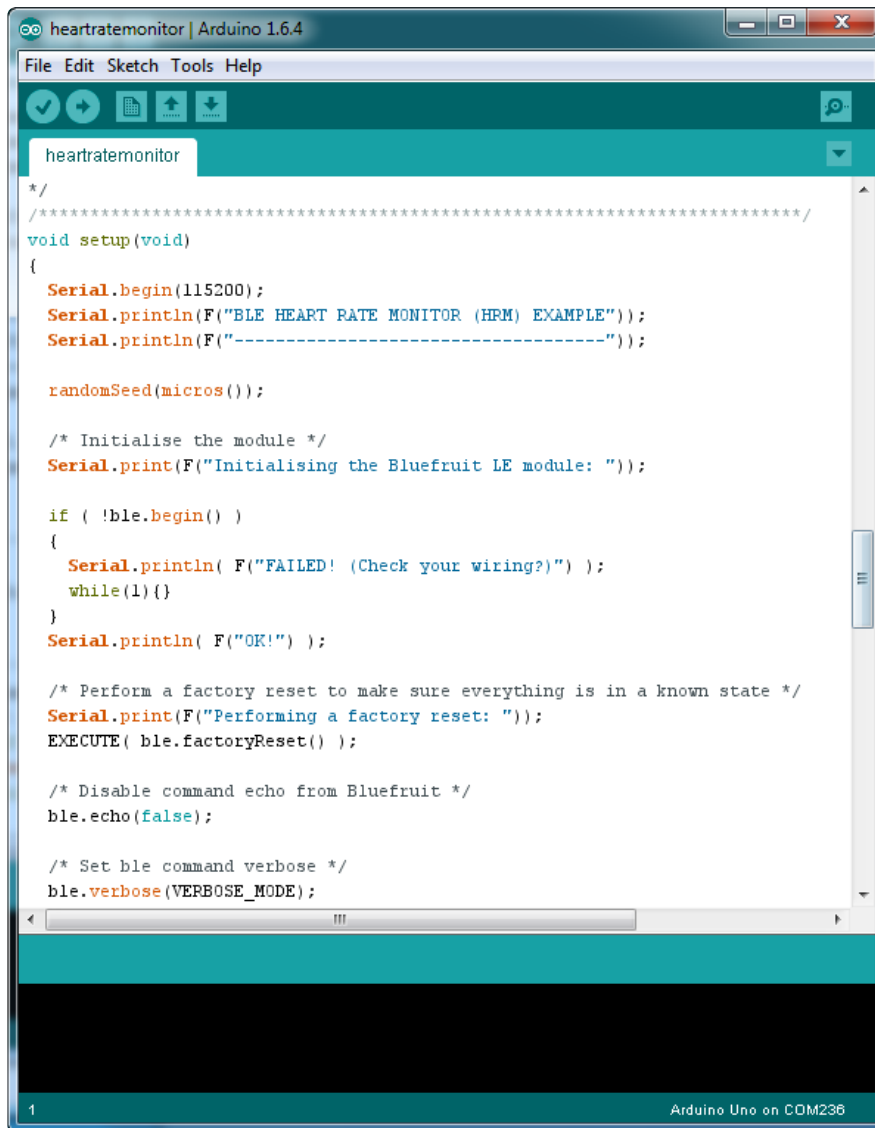

Configuration

Check the Configuration! page earlier to set up the sketch for Software/Hardware UART or Software/Hardware SPI. The default is hardware SPI

If Using Hardware or Software UART

This tutorial does not need to use the MODE pin, make sure you have the mode switch in CMD mode if you do not configure & connect a MODE pin

This demo uses some long data transfer strings, so we recommend defining and connecting both CTS and RTS to pins, even if you are using hardware serial.

If you are using a Flora or just don't want to connect CTS or RTS, set the pin #define's to -1 and Don't forget to also connect the CTS pin on the Bluefruit to ground! (The Flora has this already done)

If you are using RTS and CTS, you can remove this line below, which will slow down the data transmission

```
// this line is particularly required for Flora, but is a good idea
// anyways for the super long lines ahead!
ble.setInterCharWriteDelay(5); // 5 ms
```

Running the Sketch

Once you upload the sketch to your board (via the arrow-shaped upload icon), and the upload process has finished, open up the Serial Monitor via Tools > Serial Monitor, and make sure that the baud rate in the lower right-hand corner is set to 115200:

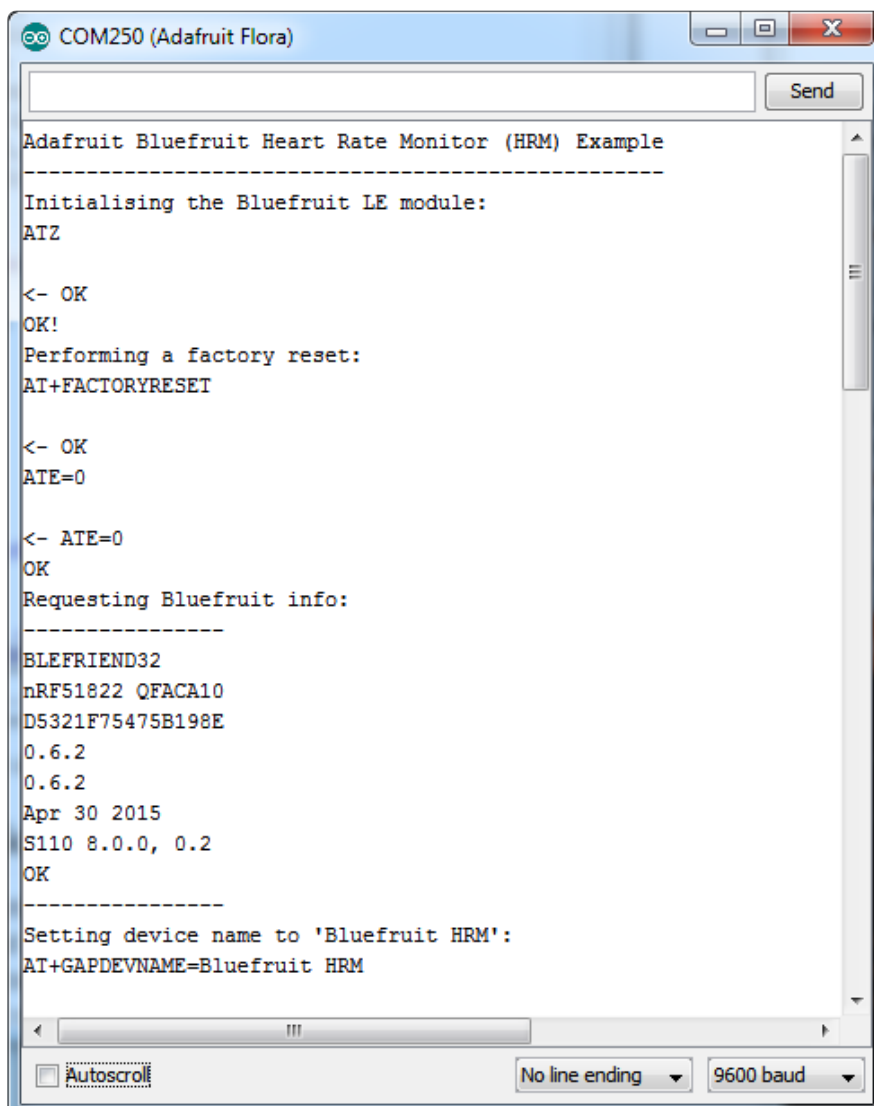

```
COM250 (Adafruit Flora)
Setting device name to 'Bluefruit HRM':
AT+GAPDEVNAME=Bluefruit HRM

<- OK
Adding the Heart Rate Service definition (UUID = 0x180D):
AT+GATTADDSERVICE=UUID=0x180D

<- 1

<- OK
Adding the Heart Rate Measurement characteristic (UUID = 0x2A37):
AT+GATTADDCHAR=UUID=0x2A37, PROPERTIES=0x10, MIN_LEN=2, MAX_LEN=3, VALUE=00-40

<- 1

<- OK
Adding the Body Sensor Location characteristic (UUID = 0x2A38):
AT+GATTADDCHAR=UUID=0x2A38, PROPERTIES=0x02, MIN_LEN=1, VALUE=3

<- 2

<- OK
Adding Heart Rate Service UUID to the advertising payload: AT+GAPSETADVDATA=02-01-06-05-02-0d-18-0a-18

<- OK
Performing a SW reset (service changes require a reset): ATZ

<- OK

Updating HRM value to 82 BPM
AT+GATTCHAR=1,00-52

<- OK
Updating HRM value to 61 BPM
AT+GATTCHAR=1,00-3D

Autoscroll No line ending 9600 baud
```

If you open up an application on your mobile device or laptop that support the standard [Heart Rate Monitor Service \(https://adafru.it/f4I\)](https://adafru.it/f4I), you should be able to see the heart rate being updated in sync with the changes seen in the Serial Monitor:

nRF Toolbox HRM Example

The image below is a screenshot from the free [nRF Toolbox \(https://adafru.it/e9M\)](https://adafru.it/e9M) app from Nordic on Android (also available on [iOS \(https://adafru.it/f4J\)](https://adafru.it/f4J)), showing the incoming Heart Rate Monitor data:

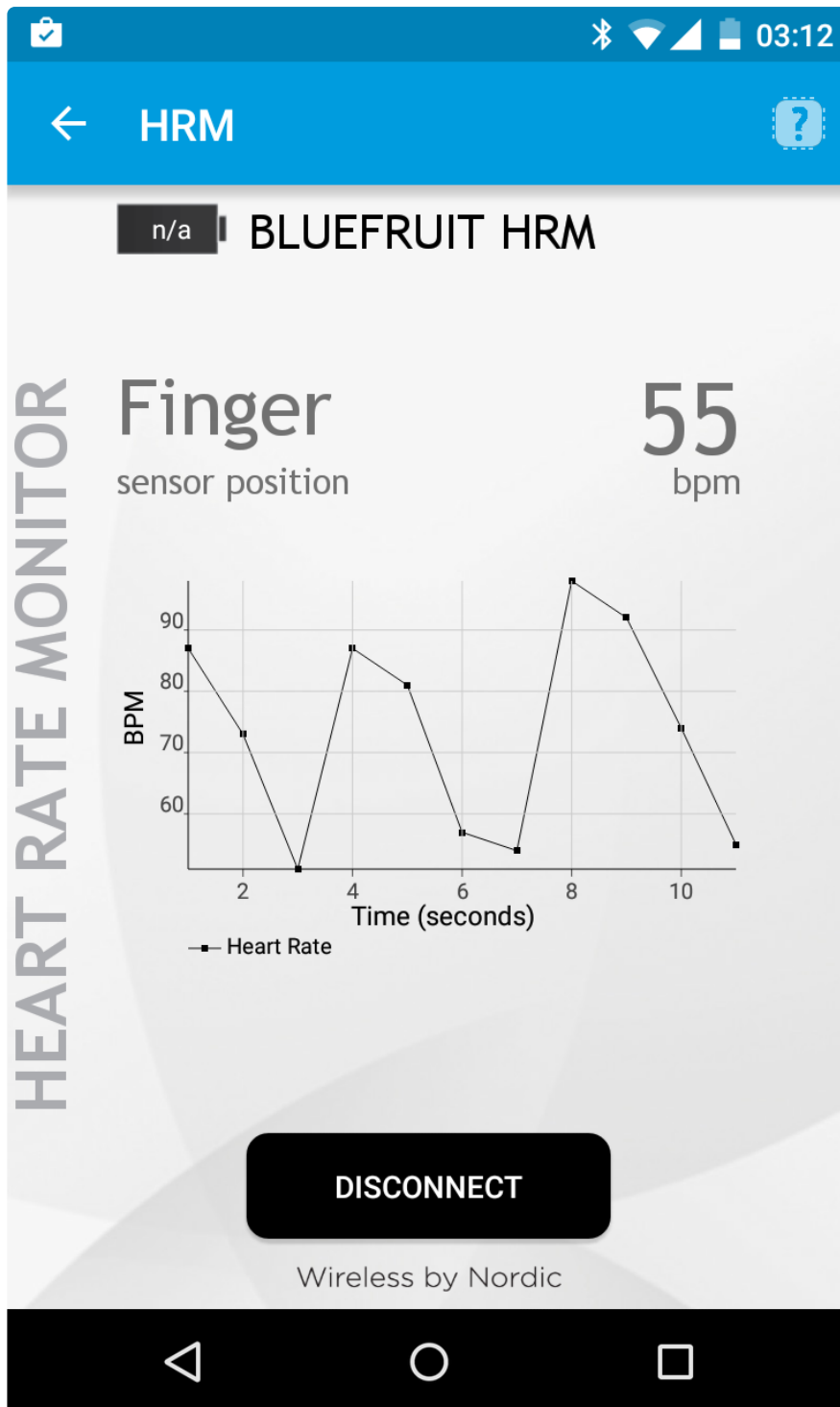

CoreBluetooth HRM Example

The image below is from a freely available [CoreBluetooth sample application \(https://adafru.it/f4K\)](https://adafru.it/f4K) from Apple showing how to work with Bluetooth Low Energy services and characteristics:

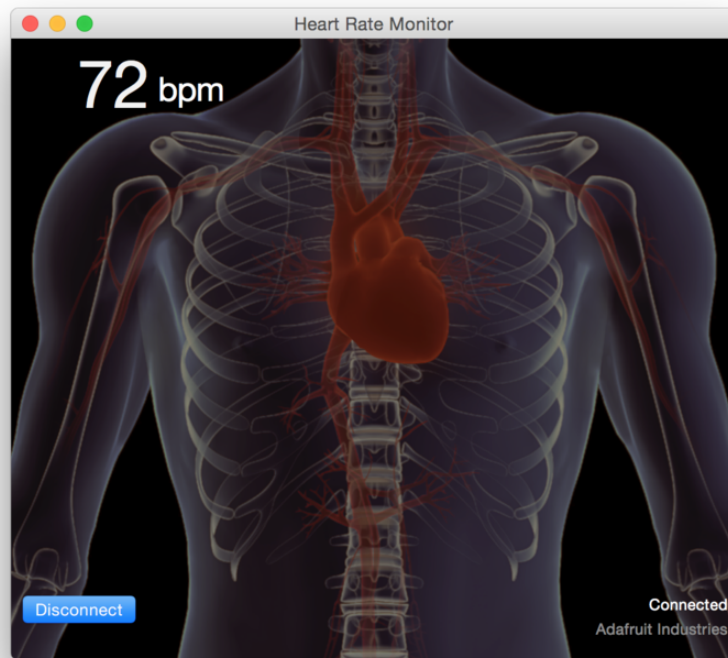

UriBeacon

The UriBeacon example shows you how to use the built-in UriBeacon AT commands to configure the Bluefruit LE module as a UriBeacon advertiser, following Google's Physical Web [UriBeacon \(https://adafru.it/edk\)](https://adafru.it/edk) specification.

Opening the Sketch

To open the ATCommand sketch, click on the File > Examples > Adafruit_BluefruitLE_nRF51 folder in the Arduino IDE and select uribeacon:

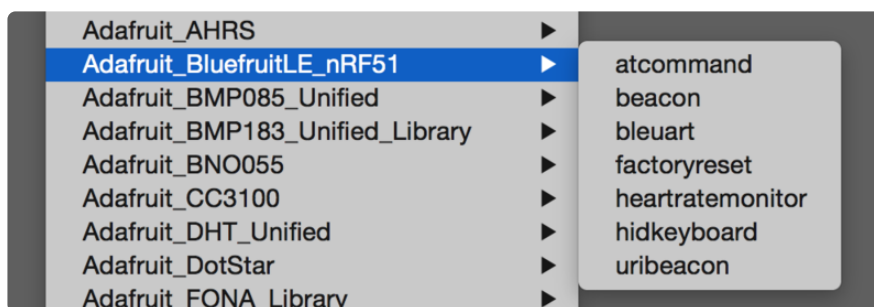

This will open up a new instance of the example in the IDE, as shown below. You can edit the URL that the beacon will point to, from the default <http://www.adafruit.com> or just upload as is to test

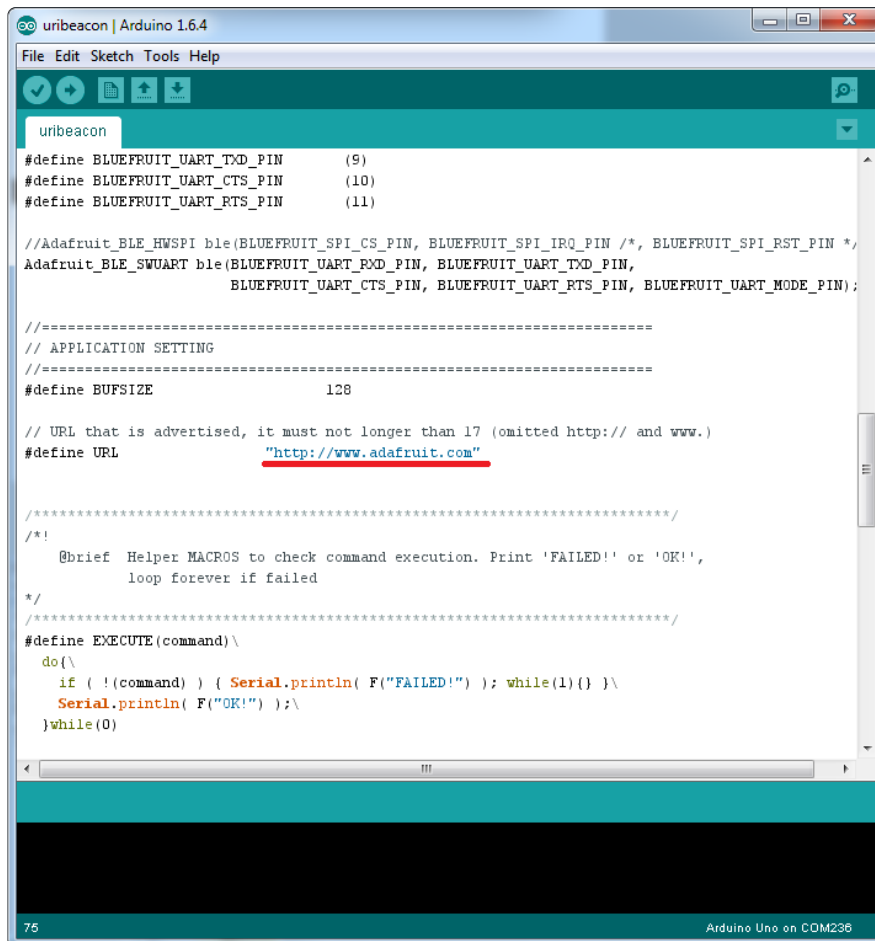

Configuration

Check the Configuration! page earlier to set up the sketch for Software/Hardware UART or Software/Hardware SPI. The default is hardware SPI

If using software or hardware Serial UART:

- This tutorial does not need to use the MODE pin, make sure you have the mode switch in CMD mode if you do not configure & connect a MODE pin
- Don't forget to also connect the CTS pin on the Bluefruit to ground if you are not using it! (The Flora has this already done)

Running the Sketch

Once you upload the sketch to your board (via the arrow-shaped upload icon), and the upload process has finished, open up the Serial Monitor via Tools > Serial Monitor, and make sure that the baud rate in the lower right-hand corner is set to 115200:

```
COM250 (Adafruit Flora)
| Send
Adafruit Bluefruit UriBeacon Example
-----
Initialising the Bluefruit LE module:
ATZ
<- OK
OK!
Performing a factory reset:
AT+FACTORYRESET
<- OK
ATE=0
<- ATE=0
OK
Requesting Bluefruit info:
-----
BLEFRIEND32
nRF51822 QFACA10
D5321F75475B198E
0.6.2
0.6.2
Apr 30 2015
S110 8.0.0, 0.2
OK
-----
Setting uri beacon to Adafruit website: AT+BLEURIBEACON=http://www.adafruit.com
<- OK
Please use Google Physical Web application to test
 Autoscroll
No line ending 115200 baud
```

At this point you can open the Physical Web Application for [Android \(https://adafru.it/edi\)](https://adafru.it/edi) or for [iOS \(https://adafru.it/edj\)](https://adafru.it/edj), and you should see a link advertising Adafruit's website:

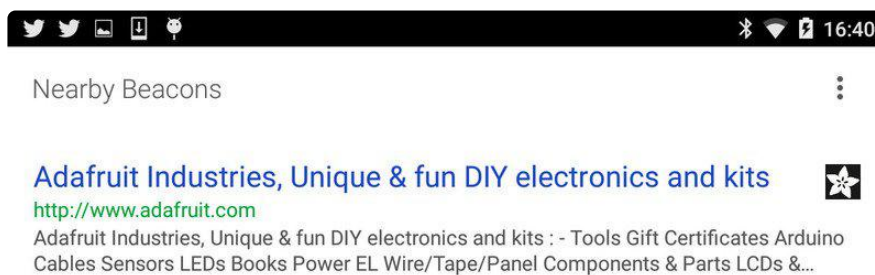

HALP!

When using the Bluefruit Micro or a Bluefruit LE with Flora/Due/Leonardo/Micro the examples dont run?

We add a special line to setup() to make it so the Arduino will halt until it sees you've connected over the Serial console. This makes debugging great but makes it so you cannot run the program disconnected from a computer.

Solution? Once you are done debugging, remove these two lines from setup()

```
while (!Serial);  
delay(500);
```

I can't seem to "Find" the Bluefruit LE!

Getting something like this?

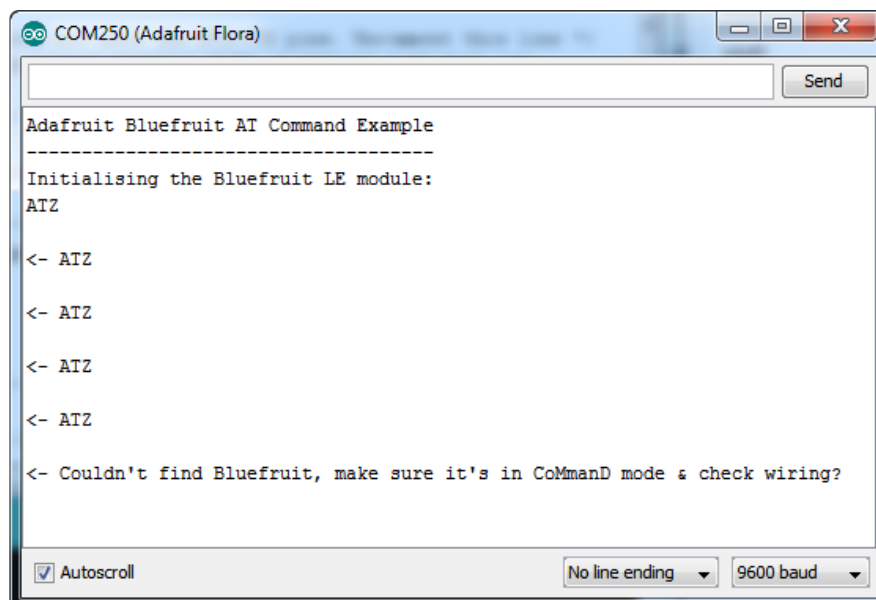

For UART/Serial Bluefruits:

- Check you have the MODE switch in CMD and the MODE pin not wired to anything if it isnt used!
- If you are trying to control the MODE from your micro, make sure you set the MODE pin in the sketch
- Make sure you have RXI and TXO wired right! They are often swapped by accident
- Make sure CTS is tied to GND if you are using hardware serial and not using CTS
- Check the MODE red LED, is it blinking? If its blinking continuously, you might be in DFU mode, power cycle the module!

- If you are using Hardware Serial/Software Serial make sure you know which one and have that set up

If using SPI Bluefruit:

- Make sure you have all 5 (or 6) wires connected properly.
- If using hardware SPI, you need to make sure you're connected to the hardware SPI port, which differs depending on the main chipset.

If using Bluefruit Micro:

- Make sure you change the RESET pin to #4 in any Config file. Also be sure you are using hardware SPI to connect!

AT Commands

The Bluefruit LE modules use a [Hayes AT-style command set \(https://adafru.it/ebJ\)](https://adafru.it/ebJ) to configure the device.

The advantage of an AT style command set is that it's easy to use in machine to machine communication, while still being somewhat user friendly for humans.

Test Command Mode '=?'

'Test' mode is used to check whether or not the specified command exists on the system or not.

Certain firmware versions or configurations may or may not include a specific command, and you can determine if the command is present by taking the command name and appending '=?' to it, as shown below

```
AT+BLESTARTADV=?
```

If the command is present, the device will reply with 'OK'. If the command is not present, the device will reply with 'ERROR'.

```
AT+BLESTARTADV=?  
OK\r\n
```

```
AT+MISSINGCMD=?  
ERROR\r\n
```

Write Command Mode '=xxx'

'Write' mode is used to assign specific value(s) to the command, such as changing the radio's transmit power level using the command we used above.

To write a value to the command, simply append an '=' sign to the command followed by any parameter(s) you wish to write (other than a lone '?' character which will be interpreted as tet mode):

```
AT+BLEPOWERLEVEL=-8
```

If the write was successful, you will generally get an 'OK' response on a new line, as shown below:

```
AT+BLEPOWERLEVEL=-8  
OK\r\n
```

If there was a problem with the command (such as an invalid parameter) you will get an 'ERROR' response on a new line, as shown below:

```
AT+BLEPOWERLEVEL=3  
ERROR\r\n
```

Note: This particular error was generated because '3' is not a valid value for the AT+BLEPOWERLEVEL command. Entering '-4', '0' or '4' would succeed since these are all valid values for this command.

Execute Mode

'Execute' mode will cause the specific command to 'run', if possible, and will be used when the command name is entered with no additional parameters.

```
AT+FACTORYRESET
```

You might use execute mode to perform a factory reset, for example, by executing the AT+FACTORYRESET command as follows:

```
AT+FACTORYRESET
OK\r\n
```

NOTE: Many commands that are means to be read will perform the same action whether they are sent to the command parser in 'execute' or 'read' mode. For example, the following commands will produce identical results:

```
AT+BLEGETPOWERLEVEL
-4\r\n
OK\r\n
AT+BLEGETPOWERLEVEL?
-4\r\n
OK\r\n
```

If the command doesn't support execute mode, the response will normally be 'ERROR' on a new line.

Read Command Mode '?'

'Read' mode is used to read the current value of a command.

Not every command supports read mode, but you generally use this to retrieve information like the current transmit power level for the radio by appending a '?' to the command, as shown below:

```
AT+BLEPOWERLEVEL?
```

If the command doesn't support read mode or if there was a problem with the request, you will normally get an 'ERROR' response.

If the command read was successful, you will normally get the read results followed by 'OK' on a new line, as shown below:

```
AT+BLEPOWERLEVEL?
-4\r\n
OK\r\n
```

Note: For simple commands, 'Read' mode and 'Execute' mode behave identically.

Standard AT

The following standard Hayes/AT commands are available on Bluefruit LE modules:

AT

Acts as a ping to check if we are in command mode. If we are in command mode, we should receive the 'OK' response.

Codebase Revision: 0.3.0

Parameters: None

Output: None

```
AT
OK
```

ATI

Displays basic information about the Bluefruit module.

Codebase Revision: 0.3.0

Parameters: None

Output: Displays the following values:

- Board Name
- Microcontroller/Radio SoC Name
- Unique Serial Number
- Core Bluefruit Codebase Revision
- Project Firmware Revision
- Firmware Build Date
- Softdevice, Softdevice Version, Bootloader Version (0.5.0+)

```
ATI
BLEFRIEND
nRF51822 QFAAG00
FB462DF92A2C8656
0.5.0
0.5.0
Feb 24 2015
S110 7.1.0, 0.0
OK
```

Updates:

- Version 0.4.7+ of the firmware adds the chip revision after the chip name if it can be detected (ex. 'nRF51822 QFAAG00').
- Version 0.5.0+ of the firmware adds a new 7th record containing the softdevice, softdevice version and bootloader version (ex. 'S110 7.1.0, 0.0').

ATZ

Performs a system reset.

Codebase Revision: 0.3.0

Parameters: None

Output: None

```
ATZ
OK
```

ATE

Enables or disables echo of input characters with the AT parser

Codebase Revision: 0.3.0

Parameters: '1' = enable echo, '0' = disable echo

Output: None

```
# Disable echo support
ATE=0
OK
#Enable echo support
ATE=1
OK
```

+++

Dynamically switches between DATA and COMMAND mode without changing the physical CMD/UART select switch.

When you are in COMMAND mode, entering '+++\n' or '+++r\n' will cause the module to switch to DATA mode, and anything typed into the console will go direct to the BLUE UART service.

To switch from DATA mode back to COMMAND mode, simply enter '+++\n' or '+++r\n' again (be sure to include the new line character!), and a new 'OK' response will be displayed letting you know that you are back in COMMAND mode (see the two 'OK' entries in the sample code below).

Codebase Revision: 0.4.7

Parameters: None

Output: None

Note that +++ can also be used on the mobile device to send and receive AT command on iOS or Android, though this should always be used with care.

See the AT+MODESWITCHEN command to control the availability of the +++ command

```
ATI
BLEFRIEND
nRF51822 QFAAG00
B122AAC33F3D2296
0.4.6
0.4.6
Dec 22 2014
OK
+++
OK
OK
```

General Purpose

The following general purpose commands are available on all Bluefruit LE modules:

AT+FACTORYRESET

Clears any user config data from non-volatile memory and performs a factory reset before resetting the Bluefruit module.

Codebase Revision: 0.3.0

Parameters: None

Output: None

```
AT+FACTORYRESET
OK
```

As of version 0.5.0+ of the firmware, you can perform a factory reset by holding the DFU button down for 10s until the blue CONNECTED LED lights up, and then releasing the button.

AT+DFU

Forces the module into DFU mode, allowing over the air firmware updates using a dedicated DFU app on iOS or Android.

Codebase Revision: 0.3.0

Parameters: None

Output: None

The AT parser will no longer respond after the AT+DFU command is entered, since normal program execution effectively halts and a full system reset is performed to start the bootloader code

```
AT+DFU
OK
```

AT+HELP

Displays a comma-separated list of all AT parser commands available on the system.

Codebase Version: 0.3.0

Parameters: None

Output: A comma-separated list of all AT parser commands available on the system.

The sample code below may not match future firmware releases and is provided for illustration purposes only

```
AT+HELP
AT+FACTORYRESET,AT+DFU,ATZ,ATI,ATE,AT+DBGMEMRD,AT+DBGVMRD,AT+HWLEDPOLARITY,AT+HWLED,AT+HWGETD
OK
```

AT+NVMWRITE

Writes data to the 256 byte user non-volatile memory (NVM) region.

Codebase Version: 0.7.0

Parameters:

- offset: The numeric offset for the first byte from the starting position in the user NVM
- datatype: Which can be one of STRING (1), BYTEARRAY (2) or INTEGER (3)
- data: The data to write to NVM memory (the exact payload format will change based on the specified datatype).

Output: Nothing

```
# Write 32768 as an integer starting at byte 16 in user NVM
AT+NVMWRITE=16,INTEGER,32768
OK
```

AT+NVMREAD

Reads data from the 256 byte user non-volatile memory (NVM) region.

Codebase Version: 0.7.0

Parameters:

- offset: The numeric offset for the first byte from the starting position in the user NVM
- size: The number of bytes to read
- datatype: The type used for the data being read, which is required to properly parse the data and display it as a response. The value can be one of STRING (1), BYTEARRAY (2) or INTEGER (3)

Output: The data read back, formatted based on the datatype argument.

```
# Read an integer back from position 16 in user NVM
AT+NVMREAD=16, 4, INTEGER
32768
OK
```

AT+MODESWITCHEN

Enables or disables mode switches via the '+++' command on the BLE peripheral of BLE UART side of the connection.

Codebase Version: 0.7.1

Parameters:

- location: This can be a string, either 'local' or 'ble' indicating which side should have the '+++' command enabled or disabled, 'local' being the Bluefruit peripheral and 'ble' being the phone or tablet.
- state: '0' to disable '+++' mode switches, '1' to enable them.

Output: None

By default, '+++' is enabled locally, and disabled in BLE

```
# Disable remote '+++' mode switches
AT+MODESWITCHEN=ble,0
OK
```

Hardware

The following commands allow you to interact with the low level HW on the Bluefruit LE module, such as reading or toggling the GPIO pins, performing an ADC conversion ,etc.:

AT+BAUDRATE

Changes the baud rate used by the HW UART peripheral on the nRF51822. Note that we do not recommend using higher baudrates than 9600 because the nRF51 UART can drop characters!

Codebase Revision: 0.7.0

Parameters: Baud rate, which must be one of the following values:

- 1200
- 2400
- 4800
- 9600
- 14400
- 19200
- 28800
- 38400
- 57600
- 76800
- 115200
- 230400
- 250000
- 460800
- 921600
- 1000000

Output: The current baud rate

```
# Set the baud rate to 115200
AT+BAUDRATE=115200
OK

# Check the current baud rate
AT+BAUDRATE
115200
OK
```

AT+HWADC

Performs an ADC conversion on the specified ADC pin

Codebase Revision: 0.3.0

Parameters: The ADC channel (0..7)

Output: The results of the ADC conversion

```
AT+HWADC=0
178
OK
```

AT+HWGETDIETEMP

Gets the temperature in degree celcius of the BLE module's die. This can be used for debug purposes (higher die temperature generally means higher current consumption), but does not corresponds to ambient temperature and can not be used as a replacement for a normal temperature sensor.

Codebase Revision: 0.3.0

Parameters: None

Output: The die temperature in degrees celcius

```
AT+HWGETDIETEMP
32.25
OK
```

AT+HWGPIO

Gets or sets the value of the specified GPIO pin (depending on the pin's mode).

Codebase Revision: 0.3.0

Parameters: The parameters for this command change depending on the pin mode.

OUTPUT MODE: The following comma-separated parameters can be used when updating a pin that is set as an output:

- Pin numbers
- Pin state, where:
 - 0 = clear the pin (logic low/GND)
 - 1 = set the pin (logic high/VCC)

INPUT MODE: To read the current state of an input pin or a pin that has been configured as an output, enter the pin number as a single parameter.

Output: The pin state if you are reading an input or checking the state of an input pin (meaning only 1 parameter is supplied, the pin number), where:

- 0 means the pin is logic low/GND
- 1 means the pin is logic high/VCC

Trying to set the value of a pin that has not been configured as an output will produce an 'ERROR' response.

Some pins are reserved for specific functions on Bluefruit modules and can not be used as GPIO. If you try to make use of a reserved pin number an 'ERROR' response will be generated.

```
# Set pin 14 HIGH
AT+HWGPIO=14,1
OK

# Set pin 14 LOW
AT+HWGPIO=14,0
OK

# Read the current state of pin 14
```



```
AT+HWGPIO=14
0
OK

# Try to update a pin that is not set as an output
AT+HWGPIOMODE=14,0
OK
AT+HWGPIO=14,1
ERROR
```

AT+HWGPIOMODE

This will set the mode for the specified GPIO pin (input, output, etc.).

Codebase Revision: 0.3.0

Parameters: This command one or two values (comma-separated in the case of two parameters being used):

- The pin number
- The new GPIO mode, where:
 - 0 = Input
 - 1 = Output
 - 2 = Input with pullup enabled
 - 3 = Input with pulldown enabled

Output: If a single parameters is passed (the GPIO pin number) the current pin mode will be returned.

Some pins are reserved for specific functions on Bluefruit modules and can not be used as GPIO. If you try to make use of a reserved pin number an 'ERROR' response will be generated.

```
# Configure pin 14 as an output
AT+HWGPIOMODE=14,0
OK

# Get the current mode for pin 14
AT+HWGPIOMODE=14
0
OK
```

AT+HWI2CSCAN

Scans the I2C bus to try to detect any connected I2C devices, and returns the address of devices that were found during the scan process.

Codebase Revision: 0.3.0

Parameters: None

Output: A comma-separated list of any I2C address that were found while scanning the valid address range on the I2C bus, or nothing is no devices were found.

```
# I2C scan with two devices detected
AT+HWI2CSCAN
0x23,0x35
OK

# I2C scan with no devices detected
AT+HWI2CSCAN
OK
```

AT+HWVBAT

Returns the main power supply voltage level in millivolts

Codebase Revision: 0.3.0

Parameters: None

Output: The VBAT level in millivolts

```
AT+HWVBAT
3248
OK
```

AT+HWRANDOM

Generates a random 32-bit number using the HW random number generator on the nRF51822 (based on white noise).

Codebase Revision: 0.4.7

Parameters: None

Output: A random 32-bit hexadecimal value (ex. '0x12345678')

```
AT+HWRANDOM
0x769ED823
OK
```

AT+HWMODELED

Allows you to override the default behaviour of the MODE led (which indicates the operating mode by default).

Codebase Revision: 0.6.6

Parameters: LED operating mode, which can be one of the following values:

- disable or DISABLE or 0 - Disable the MODE LED entirely to save power
- mode or MODE or 1 - Default behaviour, indicates the current operating mode
- hwuart or HWUART or 2 - Toggles the LED on any activity on the HW UART bus (TX or RX)
- bleuart or BLEUART or 3 - Toggles the LED on any activity on the BLE UART Service (TX or RX characteristic)
- spi or SPI or 4 - Toggles the LED on any SPI activity
- manual or MANUAL or 5 - Manually sets the state of the MODE LED via a second comma-separated parameter, which can be on, off, or toggle.

Output: If run with no parameters, returns an upper-case string representing the current MODE LED operating mode from the fields above

```
# Get the curent MODE LED setting
AT+HWMODELED
MODE
OK

# Change the MODE LED to indicate BLE UART activity
AT+HWMODELED=BLEUART
OK

# Manually toggle the MODE LED
AT+HWMODELED=MANUAL,TOGGLE
OK
```

AT+UARTFLOW

Enables or disable hardware flow control (CTS + RTS) on the UART peripheral block of the nRF51822.

Codebase Revision: 0.7.0

Parameters: HW flow control state, which can be one of:

- on
- off
- 0
- 1

Output: If run with no parameters, returns a number representing whether flow control is enabled (1) or disabled (0).

```
# Check the current flow control state
AT+UARTFLOW
1
OK

# Disable HW flow control
AT+UARTFLOW=off
OK
```

Beacon

Adafruit's Bluefruit LE modules currently support the following 'Beacon' technologies:

- Beacon (Apple) via AT+BLEBEACON
- UriBeacon (Google) via AT+BLEURIBEACON (deprecated)
- Eddystone (Google) via AT+EDDYSTONE*

Modules can be configured to act as 'Beacons' using the following commands:

AT+BLEBEACON

Codebase Revision: 0.3.0

Parameters: The following comma-separated parameters are required to enable beacon mode:

- Bluetooth Manufacturer ID (uint16_t)
- 128-bit UUID
- Major Value (uint16_t)
- Minor Value (uint16_t)
- RSSI @ 1m (int8_t)

Output: None

```
# Enable Apple iBeacon emulation
# Manufacturer ID = 0x004C
AT+BLEBEACON=0x004C,01-12-23-34-45-56-67-78-89-9A-AB-BC-CD-DE-EF-
F0,0x0000,0x0000,-59
OK
# Reset to change the advertising data
ATZ
OK

# Enable Nordic Beacon emulation
# Manufacturer ID = 0x0059
AT+BLEBEACON=0x0059,01-12-23-34-45-56-67-78-89-9A-AB-BC-CD-DE-EF-
F0,0x0000,0x0000,-59
OK
# Reset to change the advertising data
ATZ
OK
```

AT+BLEBEACON will cause the beacon data to be stored in non-volatile config memory on the Bluefruit LE module, and these values will be persisted across system resets and power cycles. To remove or clear the beacon data you need to enter the 'AT+FACTORYRESET' command in command mode.

Entering Nordic Beacon emulation using the sample code above, you can see the simulated beacon in Nordic's 'Beacon Config' tool below:

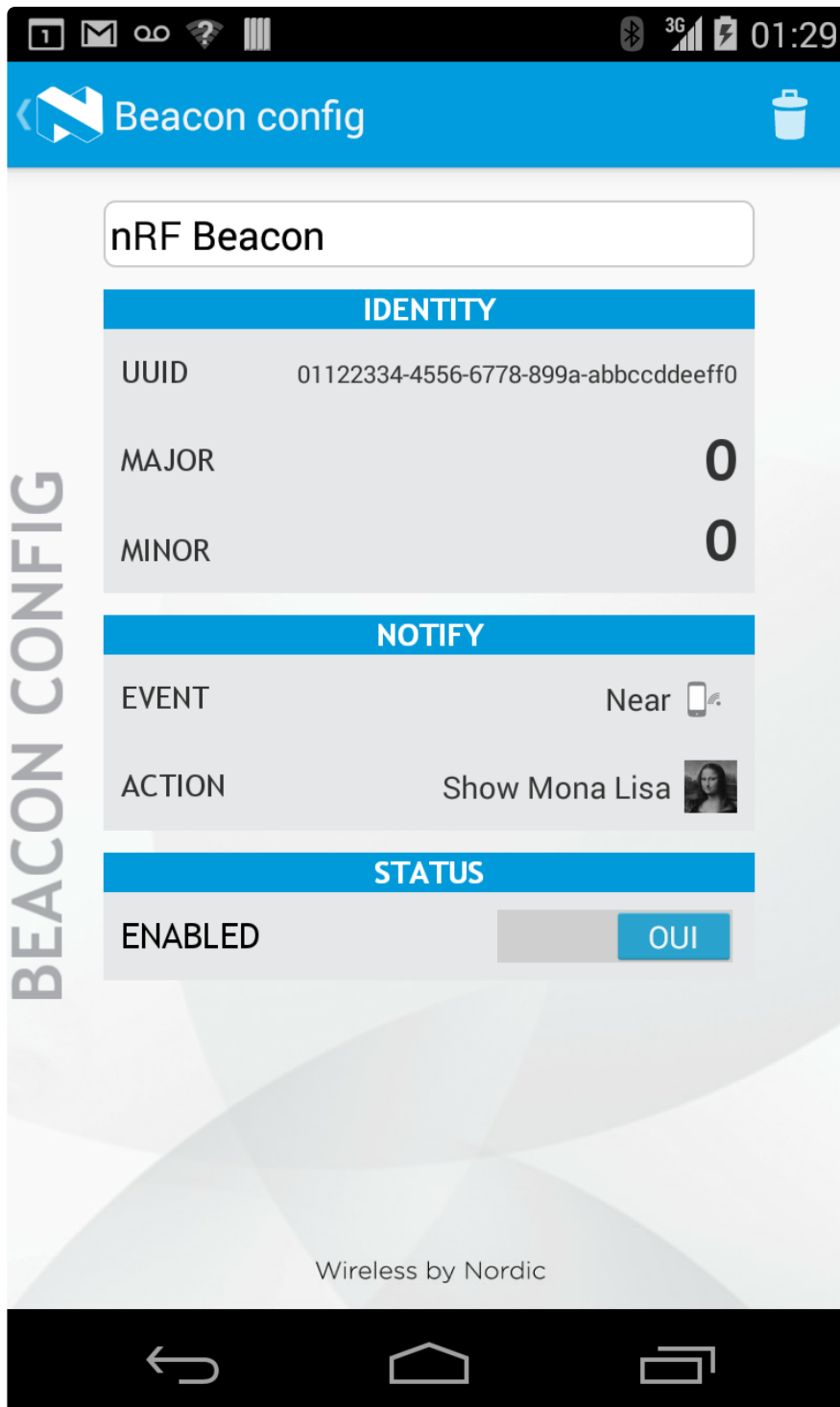

AT+BLEURIBEACON

Converts the specified URI into a [UriBeacon](https://adafru.it/edk) (https://adafru.it/edk) advertising packet, and configures the module to advertise as a UriBeacon (part of Google's [Physical Web](https://adafru.it/ehZ) (https://adafru.it/ehZ) project).

To view the UriBeacon URIs you can use one of the following mobile applications:

- Android 4.3+: [Physical Web \(https://adafru.it/edi\)](https://adafru.it/edi) on the Google Play Store
- iOS: [Physical Web \(https://adafru.it/edj\)](https://adafru.it/edj) in Apple's App Store

Codebase Revision: 0.4.7

Parameters: The URI to encode (ex. <http://www.adafruit.com/blog> (<https://adafru.it/ei0>))

Output: None of a valid URI was entered (length is acceptable, etc.).

```
AT+BLEURIBEACON=http://www.adafruit.com/blog
OK

# Reset to change the advertising data
ATZ
OK
```

If the supplied URI is too long you will get the following output:

```
AT+BLEURIBEACON=http://www.adafruit.com/this/uri/is/too/long
URL is too long
ERROR
```

If the URI that you are trying to encode is too long, try using a shortening service like bit.ly, and encode the shortened URI.

UriBeacon should be considered deprecated as a standard, and EddyStone should be used for any future development. No further development will happen in the Bluefruit LE firmware around UriBeacon.

Deprecated: AT+EDDYSTONEENABLE

This command will enable [Eddystone \(https://adafru.it/fSA\)](https://adafru.it/fSA) support on the Bluefruit LE module. Eddystone support must be enabled before the other related commands can be used.

Codebase Revision: 0.6.6

Parameters: 1 or 0 (1 = enable, 0 = disable)

Output: The current state of Eddystone support if no parameters are provided (1 = enabled, 0 = disabled)

This command was removed in firmware 0.7.0 to avoid confusion. Use `AT+EDDYSTONESERVICEEN` in 0.7.0 and higher.

```
# Enable Eddystone support
AT+EDDYSTONEENABLE=1
OK

# Check the current Eddystone status on the module
AT+EDDYSTONEENABLE
1
OK
```

AT+EDDYSTONEURL

This command will set the URL for the [Eddystone-URL \(https://adafru.it/fSB\)](https://adafru.it/fSB) protocol.

Codebase Revision: 0.6.6

Parameters:

- The URL to encode (mandatory)
- An optional second parameter indicates whether to continue advertising the Eddystone URL even when the peripheral is connected to a central device
- Firmware 0.6.7 added an optional third parameter for the RSSI at 0 meters value. This should be measured by the end user by checking the RSSI value on the receiving device at 1m and then adding 41 to that value (to compensate for the signal strength loss over 1m), so an RSSI of -62 at 1m would mean that you should enter -21 as the RSSI at 0m. Default value is -18dBm.

Output: Firmware \leq 0.6.6: none. With firmware \geq 0.6.7 running this command with no parameters will return the current URL.

```
# Set the Eddystone URL to adafruit
AT+EDDYSTONEURL=http://www.adafruit.com
OK

# Set the Eddystone URL to adafruit and advertise it even when connected
AT+EDDYSTONEURL=http://www.adafruit.com,1
OK
```

AT+EDDYSTONECONFIGEN

This command causes the Bluefruit LE module to enable the Eddystone URL config service for the specified number of seconds.

This command should be used in combination with the Physical Web application from Google, available for [Android \(https://adafru.it/edi\)](https://adafru.it/edi) or [iOS \(https://adafru.it/edj\)](https://adafru.it/edj). Run this command then select the 'Edit URL' option from the app to change the destination URL over the air.

Codebase Revision: 0.6.6

Parameters: The number of seconds to advertised the config service UUID

Output: None

```
# Start advertising the Eddystone config service for 5 minutes (300s)
AT+EDDYSTONECONFIGEN=300
OK
```

AT+EDDYSTONESEERVICEEN

Adds or removes the Eddystone service from the GATT table (requires a reset to take effect).

Codebase Revision: 0.7.0

Parameters: Whether or not the Eddystone service should be enabled or not, using one of the following values:

- on
- off
- 1
- 0

Output: If the command is executed with no parameters it will disable a numeric value indicating whether the service is enabled (1) or disabled (0).

You must perform a system reset for this command to take effect.

```
# Enable Eddystone service
AT+EddyStonServiceEn=on
OK

AT+EddyStonServiceEn=1
OK

# Disable Eddystone service
AT+EddyStonServiceEn=off
OK

AT+EddyStonServiceEn=0
OK
```

AT+EDDYSTONEBROADCAST

This command can be used to start or stop advertising the Eddystone payload using the URL stored in non-volatile memory (NVM).

Codebase Revision: 0.7.0

Parameters: Whether or not the payload should be broadcast, using one of the following values:

- on
- off
- 1
- 0

Output: If executed with no parameters, the current broadcast state will be displayed as a numeric value.

```
# Enable broadcasting current setting of EddyStone (stored previously on nvm)
AT+EddyStoneBroadcast=on
OK

AT+EddyStoneBroadcast=1
OK

# Disable broadcasting current setting of EddyStone (still stored on nvm)
AT+EddyStoneBroadcast=off
OK

AT+EddyStoneBroadcast=0
OK
```

BLE Generic

The following general purpose BLE commands are available on Bluefruit LE modules:

AT+BLEPOWERLEVEL

Gets or sets the current transmit power level for the module's radio (higher transmit power equals better range, lower transmit power equals better battery life).

Codebase Revision: 0.3.0

Parameters: The TX power level (in dBm), which can be one of the following values (from lowest to higher transmit power):

- -40
- -20
- -16
- -12
- -8
- -4
- 0
- 4

Output: The current transmit power level (in dBm)

The updated power level will take effect as soon as the command is entered. If the device isn't connected to another device, advertising will stop momentarily and then restart once the new power level has taken effect.

```
# Get the current TX power level (in dBm)
AT+BLEPOWERLEVEL
0
OK

# Set the TX power level to 4dBm (maximum value)
AT+BLEPOWERLEVEL=4
OK

# Set the TX power level to -12dBm (better battery life)
AT+BLEPOWERLEVEL=-12
OK

# Set the TX power level to an invalid value
```

```
AT+BLEPOWERLEVEL=-3
ERROR
```

AT+BLEGETADDRTYPE

Gets the address type (for the 48-bit BLE device address).

Normally this will be '1' (random), which means that the module uses a 48-bit address that was randomly generated during the manufacturing process and written to the die by the manufacturer.

Random does not mean that the device address is randomly generated every time, only that a one-time random number is used.

Codebase Revision: 0.3.0

Parameters: None

Output: The address type, which can be one of the following values:

- 0 = public
- 1 = random

```
AT+BLEGETADDRTYPE
1
OK
```

AT+BLEGETADDR

Gets the 48-bit BLE device address.

Codebase Revision: 0.3.0

Parameters: None

Output: The 48-bit BLE device address in the following format: 'AA:BB:CC:DD:EE:FF'

```
AT+BLEGETADDR
E4:C6:C7:31:95:11
OK
```

AT+BLEGETPEERADDR

Gets the 48-bit address of the peer (central) device we are connected to.

Codebase Revision: 0.6.5

Parameters: None

Output: The 48-bit address of the connected central device in hex format. The command will return ERROR if we are not connected to a central device.

Please note that the address returned by the central device is almost always a random value that will change over time, and this value should generally not be trusted. This command is provided for certain edge cases, but is not useful in most day to day scenarios.

```
AT+BLEGETPEERADDR
48:B2:26:E6:C1:1D
OK
```

AT+BLEGETRSSI

Gets the RSSI value (Received Signal Strength Indicator), which can be used to estimate the reliability of data transmission between two devices (the lower the number the better).

Codebase Revision: 0.3.0

Parameters: None

Output: The RSSI level (in dBm) if we are connected to a device, otherwise '0'

```
# Connected to an external device
AT+BLEGETRSSI
-46
OK

# Not connected to an external device
AT+BLEGETRSSI
0
OK
```

BLE Services

The following commands allow you to interact with various GATT services present on Bluefruit LE modules when running in Command Mode.

AT+BLEUARTTX

This command will transmit the specified text message out via the [UART Service \(http://adafru.it/iCn\)](http://adafru.it/iCn) while you are running in Command Mode.

Codebase Revision: 0.3.0

Parameters: The message payload to transmit. The payload can be up to 240 characters (since AT command strings are limited to a maximum of 256 bytes total).

Output: This command will produce an ERROR message if you are not connected to a central device, or if the internal TX FIFO on the Bluefruit LE module is full.

As of firmware release 0.6.2 and higher, AT+BLEUARTTX can accept a limited set of escape code sequences:

- \r = carriage return
- \n = new line
- \t = tab
- \b = backspace
- \\ = backward slash

As of firmware release 0.6.7 and higher, AT+BLEUARTTX can accept the following escape code sequence since AT+BLEUARTTX=? has a specific meaning to the AT parser:

- \? = transmits a single question mark

As of firmware release 0.7.6 and higher, AT+BLEUARTTX can accept the following escape code sequence:

- \+ = transmit a single '+' character without having to worry about `+++` mode switch combinations

ESCAPE SEQUENCE NOTE: If you are trying to send escape sequences in code via something like 'ble.print(...)'; please note that you will need to send a double back-slash for the escape code to arrive as-intended in the AT command. For example: ble.println("AT+BLEUARTTX=Some Test\\r\\n");

You must be connected to another device for this command to execute

```
# Send a string when connected to another device
AT+BLEUARTTX=THIS IS A TEST
OK

# Send a string when not connected
AT+BLEUARTTX=THIS IS A TEST
ERROR
```

TX FIFO Buffer Handling

Starting with firmware version 0.6.7, when the TX FIFO buffer is full a 200ms blocking delay will be used to see if any free space becomes available in the FIFO before returning ERROR. The exact process is detailed in the flow chart below:

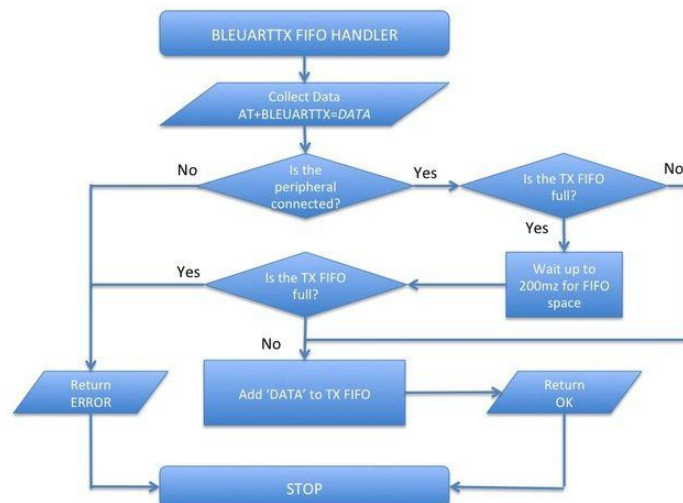

Note: The TX FIFO full check will happen for each GATT transaction (of up to 20 bytes of data each), so large data transfers may have multiple 200ms wait states.

You can use the [AT+BLEUARTFIFO=TX](https://adafru.it/id3) (<https://adafru.it/id3>) command to check the size of the TX FIFO before sending data to ensure that you have enough free space available in the buffer.

The TX FIFO has the following size, depending on the firmware version used:

- Firmware $\leq 0.6.6$: 160 characters wide
- Firmware $\geq 0.6.7$: 1024 characters wide

It IS possible with large data transfers that part of the payload can be transmitted, and the command can still produce an ERROR if the FIFO doesn't empty in time in the middle of the payload transfer (since data is transmitted in maximum 20 byte chunks). If you need to ensure reliable data transfer, you should always check the TX FIFO size before sending data, which you can do using the AT+BLEUARTFIFO command. If not enough space is available for the entire payload, add a SW delay until enough space is available. Any single AT+BLEUARTTX command can fit into the FIFO, but multiple large instances of this command may cause the FIFO to fill up mid transfer.

AT+BLEUARTTXF

This is a convenience function that serves the same purpose as AT+BLEUARTTX, but data is immediately sent in a single BLE packet ('F' for force packet). This command will accept a maximum of 20 characters, which is the limit of what can be sent in a single packet.

Codebase Revision: 0.7.6

Parameters: See AT+BLEUARTTX

Output: See AT+BLEUARTTX

AT+BLEUARTRX

This command will dump the [UART service \(https://adafru.it/iCn\)](https://adafru.it/iCn)'s RX buffer to the display if any data has been received from the UART service while running in Command Mode. The data will be removed from the buffer once it is displayed using this command.

Any characters left in the buffer when switching back to Data Mode will cause the buffered characters to be displayed as soon as the mode switch is complete (within the limits of available buffer space, which is 1024 bytes on current black 32KB SRAM)

devices, or 160 bytes for the blue first generation BLEFriend board based on 16KB SRAM parts).

Codebase Revision: 0.3.0

Parameters: None

Output: The RX buffer's content if any data is available, otherwise nothing.

You can also use the `AT+BLEUARTFIFO=RX` command to check if any incoming data is available or not.

```
# Command results when data is available
AT+BLEUARTRX
Sent from Android
OK

# Command results when no data is available
AT+BLEUARTRX
OK
```

AT+BLEUARTFIFO

This command will return the free space available in the BLE UART TX and RX FIFOs. If you are transmitting large chunks of data, you may want to check if you have enough free space in the TX FIFO before sending, keeping in mind that individual GATT packets can contain up to 20 user bytes each.

Codebase Revision: 0.6.7

Parameters: Running this command with no parameters will return two comma-separated values indicating the free space in the TX buffer, following by the RX buffer. To request a specific buffer, you can execute the command with either a "TX" or "RX" value (For example: "AT+BLEUARTFIFO=TX").

Output: The free space remaining in the TX and RX FIFO buffer if no parameter is present, otherwise the free space remaining in the specified FIFO buffer.

```
AT+BLEUARTFIFO
1024,1024
OK

AT+BLEUARTFIFO=TX
1024
OK
```

```
AT+BLEUARTFIFO=RX
1024
OK
```

AT+BLEKEYBOARDEN

This command will enable GATT over HID (GoH) keyboard support, which allows you to emulate a keyboard on supported iOS and Android devices. By default HID keyboard support is disabled, so you need to set BLEKEYBOARDEN to 1 and then perform a system reset before the keyboard will be enumerated and appear in the Bluetooth preferences on your phone, where it can be bonded as a BLE keyboard.

Codebase Revision: 0.5.0

Parameters: 1 or 0 (1 = enable, 0 = disable)

Output: None

As of firmware version 0.6.6 this command is now an alias for AT+BLEHIDEN

You must perform a system reset (ATZ) before the changes take effect!

Before you can use your HID over GATT keyboard, you will need to bond your mobile device with the Bluefruit LE module in the Bluetooth preferences panel.

```
# Enable BLE keyboard support then reset
AT+BLEKEYBOARDEN=1
OK
ATZ
OK

# Disable BLE keyboard support then reset
AT+BLEKEYBOARDEN=0
OK
ATZ
OK
```

AT+BLEKEYBOARD

Sends text data over the BLE keyboard interface (if it has previously been enabled via AT+BLEKEYBOARDEN).

Any valid alpha-numeric character can be sent, and the following escape sequences are also supported:

- \r - Carriage Return
- \n - Line Feed
- \b - Backspace
- \t - Tab
- \\ - Backslash

As of version 0.6.7 you can also use the following escape code when sending a single character ('AT+BLEKEYBOARD=?' has another meaning for the AT parser):

- \? - Question mark

Codebase Revision: 0.5.0

Parameters: The text string (optionally including escape characters) to transmit

Output: None

```
# Send a URI with a new line ending to execute in Chrome, etc.
AT+BLEKEYBOARD=http://www.adafruit.com\r\n
OK

# Send a single question mark (special use case, 0.6.7+)
AT+BLEKEYBOARD=\?
OK
```

AT+BLEKEYBOARDCODE

Sends a raw hex sequence of USB HID keycodes to the BLE keyboard interface including key modifiers and up to six alpha-numeric characters.

This command accepts the following string-encoded byte array payload, matching the way HID over GATT sends keyboard data:

- Byte 0: Modifier
- Byte 1: Reserved (should always be 00)
- Bytes 2..7: Hexadecimal value(s) corresponding to the HID keys (if no character is used you can enter '00' or leave trailing characters empty)

After a keycode sequence is sent with the AT+BLEKEYBOARDCODE command, you must send a second AT+BLEKEYBOARDCODE command with at least two 00 characters to indicate the keys were released!

Modifier Values

The modifier byte can have one or more of the following bits set:

- Bit 0 (0x01): Left Control
- Bit 1 (0x02): Left Shift
- Bit 2 (0x04): Left Alt
- Bit 3 (0x08): Left Window
- Bit 4 (0x10): Right Control
- Bit 5 (0x20): Right Shift
- Bit 6 (0x40): Right Alt
- Bit 7 (0x80): Right Window

Codebase Revision: 0.5.0

Parameters: A set of hexadecimal values separated by a hyphen ('-'). Note that these are HID scan code values, not standard ASCII values!

Output: None

HID Keyboard Codes

A list of hexadecimal-format HID keyboard codes can be found [here \(https://adafru.it/cQV\)](https://adafru.it/cQV) (see section 7), and are listed below for convenience sake:

HID key code values don't correspond to ASCII key codes! For example, 'a' has an HID keycode value of '04', and there is no keycode for an upper case 'A' since you use the modifier to set upper case values. For details, google 'usb hid keyboard scan codes', and see the example below.

```
0x00Reserved (no event indicated)
0x01Keyboard ErrorRollOver
0x02Keyboard POSTFail
0x03Keyboard ErrorUndefined
0x04Keyboard a and A
0x05Keyboard b and B
0x06Keyboard c and C
0x07Keyboard d and D
```

0x08Keyboard e and E
 0x09Keyboard f and F
 0x0AKeyboard g and G
 0x0BKeyboard h and H
 0x0CKeyboard i and I
 0x0DKeyboard j and J
 0x0EKeyboard k and K
 0x0FKeyboard l and L
 0x10Keyboard m and M
 0x11Keyboard n and N
 0x12Keyboard o and O
 0x13Keyboard p and P
 0x14Keyboard q and Q
 0x15Keyboard r and R
 0x16Keyboard s and S
 0x17Keyboard t and T
 0x18Keyboard u and U
 0x19Keyboard v and V
 0x1AKeyboard w and W
 0x1BKeyboard x and X
 0x1CKeyboard y and Y
 0x1DKeyboard z and Z
 0x1EKeyboard 1 and !
 0x1FKeyboard 2 and @
 0x20Keyboard 3 and #
 0x21Keyboard 4 and \$
 0x22Keyboard 5 and %
 0x23Keyboard 6 and ^
 0x24Keyboard 7 and &
 0x25Keyboard 8 and *
 0x26Keyboard 9 and (
 0x27Keyboard 0 and)
 0x28Keyboard Return (ENTER)
 0x29Keyboard ESCAPE
 0x2AKeyboard DELETE (Backspace)
 0x2BKeyboard Tab
 0x2CKeboard Spacebar
 0x2DKeyboard - and (underscore)
 0x2EKeyboard = and +
 0x2FKeyboard [and {
 0x30Keyboard] and }
 0x31Keyboard \ and |
 0x32Keyboard Non-US # and ~
 0x33Keyboard ; and :
 0x34Keyboard ' and "
 0x35Keyboard Grave Accent and Tilde
 0x36Keyboard , and <
 0x37Keyboard . and >
 0x38Keyboard / and ?
 0x39Keyboard Caps Lock
 0x3AKeyboard F1
 0x3BKeyboard F2
 0x3CKeyboard F3
 0x3DKeyboard F4
 0x3EKeyboard F5
 0x3FKeyboard F6
 0x40Keyboard F7
 0x41Keyboard F8
 0x42Keyboard F9
 0x43Keyboard F10
 0x44Keyboard F11
 0x45Keyboard F12
 0x46Keyboard PrintScreen
 0x47Keyboard Scroll Lock
 0x48Keyboard Pause
 0x49Keyboard Insert
 0x4AKeyboard Home
 0x4BKeyboard PageUp
 0x4CKeboard Delete Forward

0x4DKeyboard End
0x4EKeyboard PageDown
0x4FKeyboard RightArrow
0x50Keyboard LeftArrow
0x51Keyboard DownArrow
0x52Keyboard UpArrow
0x53Keypad Num Lock and Clear
0x54Keypad /
0x55Keypad *
0x56Keypad -
0x57Keypad +
0x58Keypad ENTER
0x59Keypad 1 and End
0x5AKeypad 2 and Down Arrow
0x5BKeypad 3 and PageDn
0x5CKeypad 4 and Left Arrow
0x5DKeypad 5
0x5EKeypad 6 and Right Arrow
0x5FKeypad 7 and Home
0x60Keypad 8 and Up Arrow
0x61Keypad 9 and PageUp
0x62Keypad 0 and Insert
0x63Keypad . and Delete
0x64Keyboard Non-US \ and |
0x65Keyboard Application
0x66Keyboard Power
0x67Keypad =
0x68Keyboard F13
0x69Keyboard F14
0x6AKeyboard F15
0x6BKeyboard F16
0x6CKeyboard F17
0x6DKeyboard F18
0x6EKeyboard F19
0x6FKeyboard F20
0x70Keyboard F21
0x71Keyboard F22
0x72Keyboard F23
0x73Keyboard F24
0x74Keyboard Execute
0x75Keyboard Help
0x76Keyboard Menu
0x77Keyboard Select
0x78Keyboard Stop
0x79Keyboard Again
0x7AKeyboard Undo
0x7BKeyboard Cut
0x7CKeyboard Copy
0x7DKeyboard Paste
0x7EKeyboard Find
0x7FKeyboard Mute
0x80Keyboard Volume Up
0x81Keyboard Volume Down
0x82Keyboard Locking Caps Lock
0x83Keyboard Locking Num Lock
0x84Keyboard Locking Scroll Lock
0x85Keypad Comma
0x86Keypad Equal Sign
0x87Keyboard International1
0x88Keyboard International2
0x89Keyboard International3
0x8AKeyboard International4
0x8BKeyboard International5
0x8CKeyboard International6
0x8DKeyboard International7
0x8EKeyboard International8
0x8FKeyboard International9
0x90Keyboard LANG1
0x91Keyboard LANG2

```
0x92Keyboard LANG3
0x93Keyboard LANG4
0x94Keyboard LANG5
0x95Keyboard LANG6
0x96Keyboard LANG7
0x97Keyboard LANG8
0x98Keyboard LANG9
0x99Keyboard Alternate Erase
0x9AKeyboard SysReq/Attention
0x9BKeyboard Cancel
0x9CKeyboard Clear
0x9DKeyboard Prior
0x9EKeyboard Return
0x9FKeyboard Separator
0xA0Keyboard Out
0xA1Keyboard Oper
0xA2Keyboard Clear/Again
0xA3Keyboard CrSel/Props
0xA4Keyboard ExSel
0xE0Keyboard LeftControl
0xE1Keyboard LeftShift
0xE2Keyboard LeftAlt
0xE3Keyboard Left GUI
0xE4Keyboard RightControl
0xE5Keyboard RightShift
0xE6Keyboard RightAlt
0xE7Keyboard Right GUI
```

The following example shows how you can use this command:

```
# send 'abc' with left shift key (0x02) --> 'ABC'
AT+BLEKEYBOARDCODE=02-00-04-05-06-00-00
OK
# Indicate that the keys were released (mandatory!)
AT+BLEKEYBOARDCODE=00-00
OK
```

AT+BLEHIDEN

This command will enable GATT over HID (GoH) support, which allows you to emulate a keyboard, mouse or media controller on supported iOS, Android, OSX and Windows 10 devices. By default HID support is disabled, so you need to set BLEHIDEN to 1 and then perform a system reset before the HID devices will be enumerated and appear in on your central device.

Codebase Revision: 0.6.6

Parameters: 1 or 0 (1 = enable, 0 = disable)

Output: None

You normally need to 'bond' the Bluefruit LE peripheral to use the HID commands, and the exact bonding process will change from one operating system to another.

If you have previously bonded to a device and need to clear the bond, you can run the AT+FACTORYRESET command which will erase all stored bond data on the Bluefruit LE module.

```
# Enable GATT over HID support on the Bluefruit LE module
AT+BLEHIDEN=1
OK

# Reset so that the changes take effect
ATZ
OK
```

AT+BLEHIDMOUSEMOVE

Moves the HID mouse or scroll when position the specified number of ticks.

All parameters are signed 8-bit values (-128 to +127). Positive values move to the right or down, and origin is the top left corner.

Codebase Revision: 0.6.6

Parameters: X Ticks (+/-), Y Ticks (+/-), Scroll Wheel (+/-), Pan Wheel (+/-)

Output: None

```
# Move the mouse 100 ticks right and 100 ticks down
AT+BLEHIDMOUSEMOVE=100,100
OK

# Scroll down 20 pixels or lines (depending on context)
AT+BLEHIDMOUSEMOVE=,,20,
OK

# Pan (horizontal scroll) to the right (exact behaviour depends on OS)
AT+BLEHIDMOUSEMOVE=0,0,0,100
```

AT+BLEHIDMOUSEBUTTON

Manipulates the HID mouse buttons via the specific string(s).

Codebase Revision: 0.6.6

Parameters: Button Mask String [L][R][M][B][F], Action [PRESS][CLICK][DOUBLECLICK][HOLD]

- L = Left Button
- R = Right Button
- M = Middle Button
- B = Back Button
- F = Forward Button
- If the second parameter (Action) is "HOLD", an optional third parameter can be passed specifying how long the button should be held in milliseconds.

Output: None

```
# Double click the left mouse button
AT+BLEHIDMOUSEBUTTON=L,doubleclick
OK

# Press the left mouse button down, move the mouse, then release L
# This is required to perform 'drag' then stop type operations
AT+BLEHIDMOUSEBUTTON=L
OK
AT+BLEHIDMOUSEMOVE=-100,50
OK
AT+BLEHIDMOUSEBUTTON=0
OK

# Hold the backward mouse button for 200 milliseconds (05 dependent)
AT+BLEHIDMOUSEBUTTON=B,hold,200
OK
```

AT+BLEHIDCONTROLKEY

Sends HID media control commands for the bonded device (adjust volume, screen brightness, song selection, etc.).

Codebase Revision: 0.6.6

Parameters: The HID control key to send, followed by an optional delay in ms to hold the button

The control key string can be one of the following values:

- System Controls (works on most systems)
 - BRIGHTNESS+
 - BRIGHTNESS-
- Media Controls (works on most systems)
 - PLAYPAUSE
 - MEDIANEXT
 - MEDIAPREVIOUS
 - MEDIASTOP
- Sound Controls (works on most systems)
 - VOLUME
 - MUTE
 - BASS
 - TREBLE
 - BASS_BOOST
 - VOLUME+
 - VOLUME-
 - BASS+
 - BASS-
 - TREBLE+
 - TREBLE-
- Application Launchers (Windows 10 only so far)
 - EMAILREADER
 - CALCULATOR
 - FILEBROWSER
- Browser/File Explorer Controls (Firefox on Windows/Android only)
 - SEARCH
 - HOME
 - BACK
 - FORWARD
 - STOP
 - REFRESH
 - BOOKMARKS

You can also send a raw 16-bit hexadecimal value in the '0xABCD' format. A full list of 16-bit 'HID Consumer Control Key Codes' can be found [here](https://adafru.it/cQV) (https://adafru.it/cQV)(see section 12).

Output: Normally none.

If you are not bonded and connected to a central device, this command will return ERROR. Make sure you are connected and HID support is enabled before running these commands.

```
# Toggle the sound on the bonded central device
AT+BLEHIDCONTROLKEY=MUTE
OK

# Hold the VOLUME+ key for 500ms
AT+BLEHIDCONTROLKEY=VOLUME+,500
OK

# Send a raw 16-bit Consumer Key Code (0x006F = Brightness+)
AT+BLEHIDCONTROLKEY=0x006F
OK
```

AT+BLEHIDGAMEPADEN

Enables HID gamepad support in the HID service. By default the gamepad is disabled as of version 0.7.6 of the firmware since it causes problems on iOS and OS X and should only be used on Android and Windows based devices.

Codebase Revision: 0.7.6

Parameters: Whether the gamepad service should be enabled via one of the following values:

- on
- off
- 1
- 0

Output: If executed with no parameters, a numeric value will be returned indicating whether the battery service is enabled (1) or disabled (0).

This command requires a system reset to take effect.

AT+BLEHIDGAMEPAD

Sends a specific HID gamepad payload out over BLE

Codebase Revision: 0.7.0

Parameters: The following comma-separated parameters are available:

- x: LEFT, RIGHT: If X=-1 then 'LEFT' is pressed, if X=1 then 'RIGHT' is pressed, if X=0 then neither left nor right are pressed
- y: UP, DOWN: If Y=-1 then 'UP' is pressed, if Y=1 then 'DOWN' is pressed, if Y=0 then neither up nor down are pressed
- buttons: 0x00-0xFF, which is a bit mask for 8 button 0-7

Output: Nothing

HID gamepad is disabled by default as of version 0.7.6, and must first be enabled via AT+BLEHIDGAMEPADEN=1 before it can be used.

Note: You need to send both 'press' and 'release' events for each button, otherwise the system will think that the button is still pressed until a release state is received.

```
# Press 'RIGHT' and 'Button0' at the same time
AT+BLEHIDGAMEPAD=1,0,0x01

# Press 'UP' and 'Button1' + 'Button0' at the same time
AT+BLEHIDGAMEPAD=0,-1,0x03
```

AT+BLEMIDIEN

Enables or disables the BLE MIDI service.

Codebase Revision: 0.7.0

Parameters: State, which can be one of:

- on
- off

- 0
- 1

Output: If executed with no parameters, it will return the current state of the MIDI service as an integer indicating if it is enabled (1) or disabled (0).

Note: This command will require a reset to take effect.

```
# Check the current state of the MIDI service
AT+BLEMIDIEN
1
OK

# Enable the MIDI Service
AT+BLEMIDIEN=1
OK
```

AT+BLEMIDIRX

Reads an incoming MIDI character array from the buffer.

Codebase Revision: 0.7.0

Parameters: None

Output: The midi event in byte array format

```
AT+BLEMIDIRX
90-3C-7F
OK
```

AT+BLEMIDITX

Sends a MIDI event to host.

Codebase Revision: 0.7.0

Parameters: The MIDI event in hex array format, which can be either:

- A series of full MIDI events (up to 4 events)
- Exactly 1 full MIDI event + several running events without status (up to 7)

Output: None

```
# Send 1 event (middle C with max velocity)
AT+BLEMIDITX=90-3C-7F
OK

# Send 2 events
AT+BLEMIDITX=90-3C-7F-A0-3C-7F
OK

# Send 1 full event + running event
AT+BLEMIDITX=90-3C-7F-3C-7F
OK
```

AT+BLEBATTEN

Enables the Battery Service following the definition from the Bluetooth SIG.

Codebase Revision: 0.7.0

Parameters: Whether the battery service should be enabled, via on of the following values:

- on
- off
- 1
- 0

Output: If executed with no parameters, a numeric value will be returned indicating whether the battery service is enabled (1) or disabled (0).

This command requires a system reset to take effect.

```
# Enable the Battery Service
AT+BLEBATTEN=1
OK
```

AT+BLEBATTVAL

Sets the current battery level in percentage (0..100) for the Battery Service (if enabled).

Codebase Revision: 0.7.0

Parameters: The percentage for the battery in the range of 0..100.

Output: If executed with no parameters, the current battery level stored in the characteristic.

```
# Set the battery level to 72%
AT+BLEBATTVAL=72
OK
```

BLE GAP

[GAP \(https://adafru.it/iCo\)](https://adafru.it/iCo), which stands for the Generic Access Profile, governs advertising and connections with Bluetooth Low Energy devices.

The following commands can be used to configure the GAP settings on the BLE module.

You can use these commands to modify the advertising data (for ex. the device name that appears during the advertising process), to retrieve information about the connection that has been established between two devices, or the disconnect if you no longer wish to maintain a connection.

AT+GAPCONNECTABLE

This command can be used to prevent the device from being 'connectable'.

Codebase Revision: 0.7.0

Parameters: Whether or not the device should advertise itself as connectable, using one of the following values:

- yes
- no
- 1
- 0

Output: The 'connectable' state of the device if no parameter is provided

```
# Make the device non-connectable (advertising only)
AT+GAPCONNECTABLE=0
OK
```

```
# Check the current connectability status
AT+GAPCONNECTABLE
1
OK
```

AT+GAPGETCONN

Displays the current connection status (if we are connected to another BLE device or not).

Codebase Revision: 0.3.0

Parameters: None

Output: 1 if we are connected, otherwise 0

```
# Connected
AT+GAPGETCONN
1
OK

# Not connected
AT+GAPGETCONN
0
OK
```

AT+GAPDISCONNECT

Disconnects to the external device if we are currently connected.

Codebase Revision: 0.3.0

Parameters: None

Output: None

```
AT+GAPDISCONNECT
OK
```

AT+GAPDEVNAME

Gets or sets the device name, which is included in the advertising payload for the Bluefruit LE module

Codebase Revision: 0.3.0

Parameters:

- None to read the current device name
- The new device name if you want to change the value

Output: The device name if the command is executed in read mode

Updating the device name will persist the new value to non-volatile memory, and the updated name will be used when the device is reset. To reset the device to factory settings and clean the config data from memory run the AT+FACTORYRESET command.

```
# Read the current device name
AT+GAPDEVNAME
UART
OK

# Update the device name to 'BLEFriend'
AT+GAPDEVNAME=BLEFriend
OK
# Reset to take effect
ATZ
OK
```

AT+GAPDELBONDS

Deletes and bonding information stored on the Bluefruit LE module.

Codebase Revision: 0.3.0

Parameters: None

Output: None

```
AT+GAPDELBONDS
OK
```

AT+GAPINTERVALS

Gets or sets the various advertising and connection intervals for the Bluefruit LE module.

Be extremely careful with this command since it can be easy to cause problems changing the intervals, and depending on the values selected some mobile devices may no longer recognize the module or refuse to connect to it.

Codebase Revision: 0.3.0

Parameters: If updating the GAP intervals, the following comma-separated values can be entered:

- Minimum connection interval (in milliseconds)
- Maximum connection interval (in milliseconds)
- Fast Advertising interval (in milliseconds)
- Fast Advertising timeout (in seconds)
- $\geq 0.7.0$: Low power advertising interval (in milliseconds), default = 417.5 ms

To save power, the Bluefruit modules automatically drop to a lower advertising rate after 'fast advertising timeout' seconds. The default value is 30 seconds ('Fast Advertising Timeout'). The low power advertising interval is hard-coded to approximately 0.6s in firmware $< 0.7.0$. Support to control the low power interval was added in the 0.7.0 firmware release via an optional fifth parameter.

Please note the following min and max limitations for the GAP parameters:

- Absolute minimum connection interval: 10ms
- Absolute maximum connection interval: 4000ms
- Absolute minimum fast advertising interval: 20ms
- Absolute maximum fast advertising interval: 10240ms
- Absolute minimum low power advertising interval: 20ms
- Absolute maximum low power advertising interval: 10240ms

If you only wish to update one interval value, leave the other comma-separated values empty (ex. ',,110,' will only update the third value, advertising interval).

Output: If reading the current GAP interval settings, the following comma-separated information will be displayed:

- Minimum connection interval (in milliseconds)
- Maximum connection interval (in milliseconds)
- Advertising interval (in milliseconds)
- Advertising timeout (in milliseconds)

Updating the GAP intervals will persist the new values to non-volatile memory, and the updated values will be used when the device is reset. To reset the device to factory settings and clean the config data from memory run the `AT+FACTORYRESET` command.

```
# Read the current GAP intervals
AT+GAPINTERVALS
20,100,100,30

# Update all values
AT+GAPINTERVALS=20,200,200,30
OK

# Update only the advertising interval
AT+GAPINTERVALS=,,150,
OK
```

AT+GAPSTARTADV

Causes the Bluefruit LE module to start transmitting advertising packets if this isn't already the case (assuming we aren't already connected to an external device).

Codebase Revision: 0.3.0

Parameters: None

Output: None

```
# Command results when advertising data is not being sent
AT+GAPSTARTADV
OK

# Command results when we are already advertising
AT+GAPSTARTADV
```

```
ERROR
```

```
# Command results when we are connected to another device  
AT+GAPSTARTADV  
ERROR
```

AT+GAPSTOPADV

Stops advertising packets from being transmitted by the Bluetooth LE module.

Codebase Revision: 0.3.0

Parameters: None

Output: None

```
AT+GAPSTOPADV  
OK
```

AT+GAPSETADVDATA

Sets the raw advertising data payload to the specified byte array (overriding the normal advertising data), following the guidelines in the [Bluetooth 4.0 or 4.1 Core Specification](https://adafru.it/ddd) (<https://adafru.it/ddd>).

In particular, Core Specification Supplement (CSS) v4 contains the details on common advertising data fields like 'Flags' (Part A, Section 1.3) and the various Service UUID lists (Part A, Section 1.1). A list of all possible GAP Data Types is available on the Bluetooth SIG's [Generic Access Profile](https://adafru.it/cYs) (<https://adafru.it/cYs>) page.

The Advertising Data payload consists of [Generic Access Profile](https://adafru.it/cYs) (<https://adafru.it/cYs>) data that is inserted into the advertising packet in the following format: [U8:LEN] [U8:Data Type Value] [n:Value]

WARNING: This command requires a degree of knowledge about the low level details of the Bluetooth 4.0 or 4.1 Core Specification, and should only be used by expert users. Misuse of this command can easily cause your device to be undetectable by central devices in radio range.

WARNING: This command will override the normal advertising payload and may prevent some services from acting as expected.

To restore the advertising data to the normal default values use the `AT+FACTORYRESET` command.

For example, to insert the 'Flags' Data Type (Data Type Value 0x01), and set the value to 0x06/0b00000110 (BR/EDR Not Supported and LE General Discoverable Mode) we would use the following byte array:

```
02-01-06
```

- 0x02 indicates the number of bytes in the entry
- 0x01 is the '[Data Type Value \(https://adafru.it/cYs\)](https://adafru.it/cYs)' and indicates that this is a 'Flag'
- 0x06 (0b00000110) is the Flag value, and asserts the following fields (see Core Specification 4.0, Volume 3, Part C, 18.1):
 - LE General Discoverable Mode (i.e. anyone can discover this device)
 - BR/EDR Not Supported (i.e. this is a Bluetooth Low Energy only device)

If we also want to include two 16-bit service UUIDs in the advertising data (so that listening devices know that we support these services) we could append the following data to the byte array:

```
05-02-0D-18-0A-18
```

- 0x05 indicates that the number of bytes in the entry (5)
- 0x02 is the '[Data Type Value \(https://adafru.it/cYs\)](https://adafru.it/cYs)' and indicates that this is an 'Incomplete List of 16-bit Service Class UUIDs'
- 0x0D 0x18 is the first 16-bit UUID (which translates to 0x180D, corresponding to the [Heart Rate Service \(https://adafru.it/ddB\)](https://adafru.it/ddB)).
- 0x0A 0x18 is another 16-bit UUID (which translates to 0x180A, corresponding to the [Device Information Service \(https://adafru.it/ecj\)](https://adafru.it/ecj)).

Including the service UUIDs is important since some mobile applications will only work with devices that advertise a specific service UUID in the advertising packet. This is true for most apps from Nordic Semiconductors, for example.

Codebase Revision: 0.3.0

Parameters: The raw byte array that should be inserted into the advertising data section of the advertising packet, being careful to stay within the space limits defined by the Bluetooth Core Specification.

Response: None

```
# Advertise as Discoverable and BLE only with 16-bit UUIDs 0x180D and 0x180A
AT+GAPSETADVDATA=02-01-06-05-02-0d-18-0a-18
OK
```

The results of this command can be seen in the screenshot below, taken from a sniffer analyzing the advertising packets in Wireshark. The advertising data payload is highlighted in blue in the raw byte array at the bottom of the image, and the packet analysis is in the upper section:

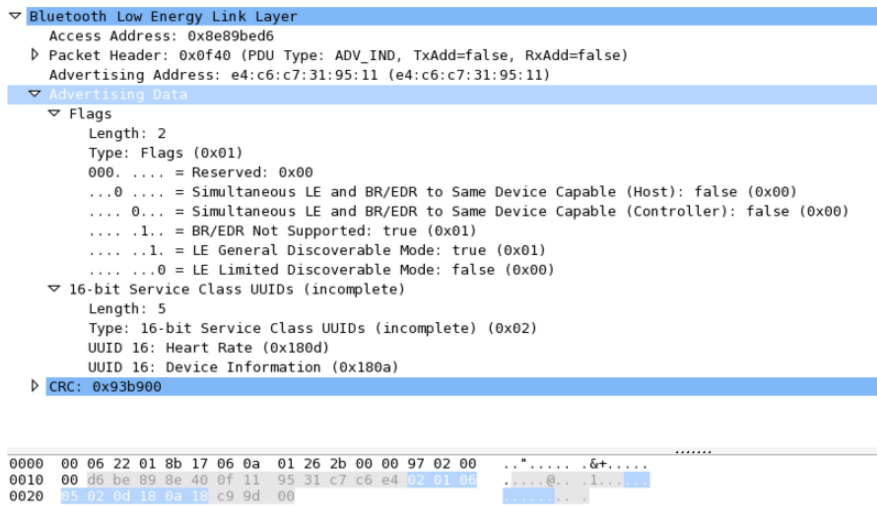

BLE GATT

[GATT \(https://adafru.it/iCp\)](https://adafru.it/iCp), which standards for the Generic ATtribute Profile, governs data organization and data exchanges between connected devices. One device (the peripheral) acts as a GATT Server, which stores data in Attribute records, and the second device in the connection (the central) acts as a GATT Client, requesting data from the server whenever necessary.

The following commands can be used to create custom GATT services and characteristics on the BLEFriend, which are used to store and exchange data.

Please note that any characteristics that you define here will automatically be saved to non-volatile FLASH config memory on the device and re-initialised the next time the device starts.

You need to perform a system reset via 'ATZ' before most of the commands below will take effect!

GATT Limitations

The commands below have the following limitations due to SRAM and resource availability, which should be kept in mind when creating or working with customer GATT services and characteristics.

These values apply to firmware 0.7.0 and higher:

- Maximum number of services: 10
- Maximum number of characteristics: 30
- Maximum buffer size for each characteristic: 32 bytes
- Maximum number of CCCDs: 16

If you want to clear any previous config value, enter the 'AT+FACTORYRESET' command before working on a new peripheral configuration.

AT+GATTCLEAR

Clears any custom GATT services and characteristics that have been defined on the device.

Codebase Revision: 0.3.0

Parameters: None

Response: None

```
AT+GATTCLEAR
OK
```

AT+GATTADDSERVICE

Adds a new custom service definition to the device.

Codebase Revision: 0.3.0

Parameters: This command accepts a set of comma-separated key-value pairs that are used to define the service properties. The following key-value pairs can be used:

- **UUID:** The 16-bit UUID to use for this service. 16-bit values should be in hexadecimal format (0x1234).
- **UUID128:** The 128-bit UUID to use for this service. 128-bit values should be in the following format: 00-11-22-33-44-55-66-77-88-99-AA-BB-CC-DD-EE-FF

Response: The index value of the service in the custom GATT service lookup table. (It's important to keep track of these index values to work with the service later.)

Note: Key values are not case-sensitive

Only one UUID type can be entered for the service (either UUID or UUID128)

```
# Clear any previous custom services/characteristics
AT+GATTCLEAR
OK

# Add a battery service (UUID = 0x180F) to the peripheral
AT+GATTADDSERVICE=UUID=0x180F
1
OK

# Add a battery measurement characteristic (UUID = 0x2A19), notify enabled
AT+GATTADDCHAR=UUID=0x2A19,PROPERTIES=0x10,MIN_LEN=1,VALUE=100
1
OK
```

```
# Clear any previous custom services/characteristics
AT+GATTCLEAR
OK

# Add a custom service to the peripheral
AT+GATTADDSERVICE=UUID128=00-11-00-11-44-55-66-77-88-99-AA-BB-CC-DD-EE-FF
1
OK

# Add a custom characteristic to the above service (making sure that there
# is no conflict between the 16-bit UUID and bytes 3+4 of the 128-bit service UUID)
AT+GATTADDCHAR=UUID=0x0002,PROPERTIES=0x02,MIN_LEN=1,VALUE=100
```

AT+GATTADDCHAR

Adds a custom characteristic to the last service that was added to the peripheral (via AT+GATTADDSERVICE).

AT+GATTADDCHAR must be run AFTER AT+GATTADDSERVICE, and will add the new characteristic to the last service definition that was added.

As of version 0.6.6 of the Bluefruit LE firmware you can now use custom 128-bit UUIDs with this command. See the example at the bottom of this command description.

Codebase Revision: 0.3.0

Parameters: This command accepts a set of comma-separated key-value pairs that are used to define the characteristic properties. The following key-value pairs can be used:

- **UUID:** The 16-bit UUID to use for the characteristic (which will be inserted in the 3rd and 4th bytes of the parent service's 128-bit UUID). This value should be entered in hexadecimal format (ex. 'UUID=0x1234'). This value must be unique, and should not conflict with bytes 3+4 of the parent service's 128-bit UUID.
- **PROPERTIES:** The 8-bit characteristic properties field, as defined by the Bluetooth SIG. The following values can be used:
 - 0x02 - Read
 - 0x04 - Write Without Response
 - 0x08 - Write
 - 0x10 - Notify
 - 0x20 - Indicate
- **MIN_LEN:** The minimum size of the values for this characteristic (in bytes, min = 1, max = 20, default = 1)
- **MAX_LEN:** The maximum size of the values for the characteristic (in bytes, min = 1, max = 20, default = 1)
- **VALUE:** The initial value to assign to this characteristic (within the limits of 'MIN_LEN' and 'MAX_LEN'). Value can be an integer ("-100", "27"), a hexadecimal value ("0xABCD"), a byte array ("aa-bb-cc-dd") or a string ("GATT!").

- >=0.7.0 - DATATYPE: This argument indicates the data type stored in the characteristic, and is used to help parse data properly. It can be one of the following values:
 - AUTO (0, default)
 - STRING (1)
 - BYTEARRAY (2)
 - INTEGER (3)
- >=0.7.0 - DESCRIPTION: Adds the specified string as the characteristic description entry
- >=0.7.0 - PRESENTATION: Adds the specified value as the characteristic presentation format entry

Response: The index value of the characteristic in the custom GATT characteristic lookup table. (It's important to keep track of these characteristic index values to work with the characteristic later.)

Note: Key values are not case-sensitive

Make sure that the 16-bit UUID is unique and does not conflict with bytes 3+4 of the 128-bit service UUID

```
# Clear any previous custom services/characteristics
AT+GATTCLEAR
OK

# Add a battery service (UUID = 0x180F) to the peripheral
AT+GATTADDSERVICE=UUID=0x180F
1
OK

# Add a battery measurement characteristic (UUID = 0x2A19), notify enabled
AT+GATTADDCHAR=UUID=0x2A19,PROPERTIES=0x10,MIN_LEN=1,VALUE=100
1
OK
```

```
# Clear any previous custom services/characteristics
AT+GATTCLEAR
OK

# Add a custom service to the peripheral
AT+GATTADDSERVICE=UUID128=00-11-00-11-44-55-66-77-88-99-AA-BB-CC-DD-EE-FF
1
OK

# Add a custom characteristic to the above service (making sure that there
# is no conflict between the 16-bit UUID and bytes 3+4 of the 128-bit service UUID)
AT+GATTADDCHAR=UUID=0x0002,PROPERTIES=0x02,MIN_LEN=1,VALUE=100
1
OK
```

Version 0.6.6 of the Bluefruit LE firmware added the ability to use a new 'UUID128' flag to add custom 128-bit UUIDs that aren't related to the parent service UUID (which is used when passing the 16-bit 'UUID' flag).

To specify a 128-bit UUID for your customer characteristic, enter a value resembling the following syntax:

```
# Add a custom characteristic to the above service using a
# custom 128-bit UUID
AT+GATTADDCHAR=UUID128=00-11-22-33-44-55-66-77-88-99-AA-BB-CC-DD-EE-
FF,PROPERTIES=0x02,MIN_LEN=1,VALUE=100
1
OK
```

Version 0.7.0 of the Bluefruit LE firmware added the new DESCRIPTION and PRESENTATION keywords, corresponding to the GATT [Characteristic User Description \(https://adafru.it/oIA\)](https://adafru.it/oIA) and the GATT [Characteristic Presentation Format \(https://adafru.it/oIB\)](https://adafru.it/oIB) Descriptors.

The DESCRIPTION field is a string that contains a short text description of the characteristic. Some apps may not display this data, but it should be visible using something like the Master Control Panel application from Nordic on iOS and Android.

The PRESENTATION field contains a 7-byte payload that encapsulates the characteristic presentation format data. It requires a specific set of bytes and values to work properly. See the following link for details on how to format the payload: https://developer.bluetooth.org/gatt/descriptors/Pages/DescriptorViewer.aspx?u=org.bluetooth.descriptor.gatt.characteristic_presentation_format.xml (<https://adafru.it/oIB>)

The following example shows how you might use both of these new fields:

```
AT+GATTADDCHAR=UUID=0x2A37, PROPERTIES=0x10, MIN_LEN=2, MAX_LEN=3, VALUE=00-40,
DESCRIPTION=HRM Measurement, PRESENTATION=17-00-AC-27-01-00-00
```

For the Characteristic Presentation Format we have:

- Format = IEEE-11073 32-bit FLOAT (Decimal 23, Hex 0x17)
- Exponent = 0/None
- Unit = Thermodynamic temperature: Degrees Fahrenheit (0x27AC) - [Bluetooth LE Unit List \(https://adafru.it/oID\)](https://adafru.it/oID)
- Namespace = Bluetooth SIG Assigned Number (0x01)
- Description = None (0x0000)

The results from Nordic's Master Control Panel app can be seen below:

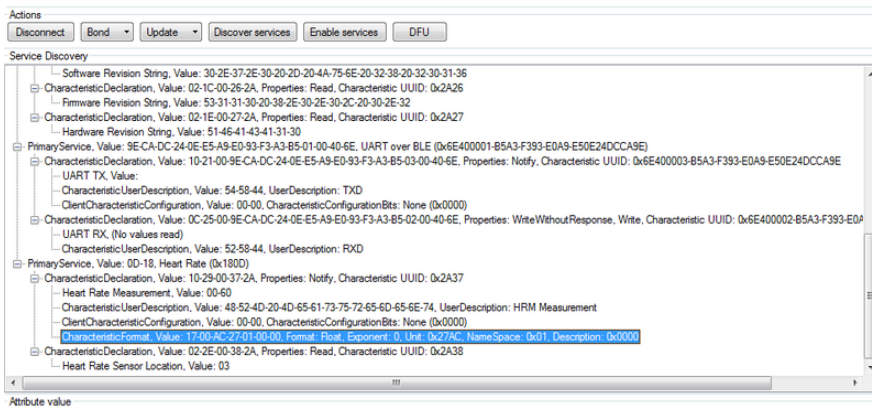

AT+GATTCHAR

Gets or sets the value of the specified custom GATT characteristic (based on the index ID returned when the characteristic was added to the system via AT+GATTADDCHAR).

Codebase Revision: 0.3.0

Parameters: This function takes one or two comma-separated functions (one parameter = read, two parameters = write).

- The first parameter is the characteristic index value, as returned from the AT+GATTADDCHAR function. This parameter is always required, and if no second parameter is entered the current value of this characteristic will be returned.
- The second (optional) parameter is the new value to assign to this characteristic (within the MIN_SIZE and MAX_SIZE limits defined when creating it).

Response: If the command is used in read mode (only the characteristic index is provided as a value), the response will display the current value of the characteristics. If the command is used in write mode (two comma-separated values are provided), the characteristics will be updated to use the provided value.

```
# Clear any previous custom services/characteristics
AT+GATTCLEAR
OK

# Add a battery service (UUID = 0x180F) to the peripheral
AT+GATTADDSERVICE=UUID=0x180F
1
OK
```

```

# Add a battery measurement characteristic (UUID = 0x2A19), notify enabled
AT+GATTADDCHAR=UUID=0x2A19,PROPERTIES=0x10,MIN_LEN=1,VALUE=100
1
OK

# Read the battery measurement characteristic (index ID = 1)
AT+GATTCHAR=1
0x64
OK

# Update the battery measurement characteristic to 32 (hex 0x20)
AT+GATTCHAR=1,32
OK

# Verify the previous write attempt
AT+GATTCHAR=1
0x20
OK

```

AT+GATTLIST

Lists all custom GATT services and characteristics that have been defined on the device.

Codebase Revision: 0.3.0

Parameters: None

Response: A list of all custom services and characteristics defined on the device.

```

# Clear any previous custom services/characteristics
AT+GATTCLEAR
OK

# Add a battery service (UUID = 0x180F) to the peripheral
AT+GATTADDSERVICE=UUID=0x180F
1
OK

# Add a battery measurement characteristic (UUID = 0x2A19), notify enabled
AT+GATTADDCHAR=UUID=0x2A19,PROPERTIES=0x10,MIN_LEN=1,VALUE=100
1
OK

# Add a custom service to the peripheral
AT+GATTADDSERVICE=UUID128=00-11-00-11-44-55-66-77-88-99-AA-BB-CC-DD-EE-FF
2
OK

# Add a custom characteristic to the above service (making sure that there
# is no conflict between the 16-bit UUID and bytes 3+4 of the 128-bit service UUID)
AT+GATTADDCHAR=UUID=0x0002,PROPERTIES=0x02,MIN_LEN=1,VALUE=100
2
OK

# Get a list of all custom GATT services and characteristics on the device
AT+GATTLIST
ID=01,UUID=0x180F
  ID=01,UUID=0x2A19,PROPERTIES=0x10,MIN_LEN=1,MAX_LEN=1,VALUE=0x64

```

```
ID=02,UUID=0x11, UUID128=00-11-00-11-44-55-66-77-88-99-AA-BB-CC-DD-EE-FF
ID=02,UUID=0x02,PROPERTIES=0x02,MIN_LEN=1,MAX_LEN=1,VALUE=0x64
OK
```

AT+GATTCHARRAW

This read only command reads binary (instead of ASCII) data from a characteristic. It is non-printable but has less overhead and is easier when writing libraries in Arduino.

Codebase Revision: 0.7.0

Parameters: The numeric ID of the characteristic to display the data for

Output: Binary data corresponding to the specified characteristic.

Note: This is a specialized command and no NEWLINE is present at the end of the command!

Debug

The following debug commands are available on Bluefruit LE modules:

Use these commands with care since they can easily lead to a HardFault error on the ARM core, which will cause the device to stop responding.

AT+DBGMEMRD

Displays the raw memory contents at the specified address.

Codebase Revision: 0.3.0

Parameters: The following comma-separated parameters can be used with this command:

- The starting address to read memory from (in hexadecimal form, with or without the leading '0x')
- The word size (can be 1, 2, 4 or 8)
- The number of words to read

Parameters: None

Output: The memory contents of the entire stack region

```
AT+DBGSTACKDUMP
0x20003800: CAFEF00D CAFEF00D CAFEF00D CAFEF00D
0x20003810: CAFEF00D CAFEF00D CAFEF00D CAFEF00D
0x20003820: CAFEF00D CAFEF00D CAFEF00D CAFEF00D
0x20003830: CAFEF00D CAFEF00D CAFEF00D CAFEF00D
0x20003840: CAFEF00D CAFEF00D CAFEF00D CAFEF00D
0x20003850: CAFEF00D CAFEF00D CAFEF00D CAFEF00D
0x20003860: CAFEF00D CAFEF00D CAFEF00D CAFEF00D
0x20003870: CAFEF00D CAFEF00D CAFEF00D CAFEF00D
0x20003880: CAFEF00D CAFEF00D CAFEF00D CAFEF00D
0x20003890: CAFEF00D CAFEF00D CAFEF00D CAFEF00D
0x200038A0: CAFEF00D CAFEF00D CAFEF00D CAFEF00D
0x200038B0: CAFEF00D CAFEF00D CAFEF00D CAFEF00D
0x200038C0: CAFEF00D CAFEF00D CAFEF00D CAFEF00D
0x200038D0: CAFEF00D CAFEF00D CAFEF00D CAFEF00D
0x200038E0: CAFEF00D CAFEF00D CAFEF00D CAFEF00D
0x200038F0: CAFEF00D CAFEF00D CAFEF00D CAFEF00D
0x20003900: CAFEF00D CAFEF00D CAFEF00D CAFEF00D
0x20003910: CAFEF00D CAFEF00D CAFEF00D CAFEF00D
0x20003920: CAFEF00D CAFEF00D CAFEF00D CAFEF00D
0x20003930: CAFEF00D CAFEF00D CAFEF00D CAFEF00D
0x20003940: CAFEF00D CAFEF00D CAFEF00D CAFEF00D
0x20003950: CAFEF00D CAFEF00D CAFEF00D CAFEF00D
0x20003960: CAFEF00D CAFEF00D CAFEF00D CAFEF00D
0x20003970: CAFEF00D CAFEF00D CAFEF00D CAFEF00D
0x20003980: CAFEF00D CAFEF00D CAFEF00D CAFEF00D
0x20003990: CAFEF00D CAFEF00D CAFEF00D CAFEF00D
0x200039A0: CAFEF00D CAFEF00D CAFEF00D CAFEF00D
0x200039B0: CAFEF00D CAFEF00D CAFEF00D CAFEF00D
0x200039C0: CAFEF00D CAFEF00D CAFEF00D CAFEF00D
0x200039D0: CAFEF00D CAFEF00D CAFEF00D CAFEF00D
0x200039E0: CAFEF00D CAFEF00D CAFEF00D CAFEF00D
0x200039F0: CAFEF00D CAFEF00D CAFEF00D CAFEF00D
0x20003A00: CAFEF00D CAFEF00D CAFEF00D CAFEF00D
0x20003A10: CAFEF00D CAFEF00D CAFEF00D CAFEF00D
0x20003A20: CAFEF00D CAFEF00D CAFEF00D CAFEF00D
0x20003A30: CAFEF00D CAFEF00D CAFEF00D CAFEF00D
0x20003A40: CAFEF00D CAFEF00D CAFEF00D CAFEF00D
0x20003A50: CAFEF00D CAFEF00D CAFEF00D CAFEF00D
0x20003A60: CAFEF00D CAFEF00D CAFEF00D CAFEF00D
0x20003A70: CAFEF00D CAFEF00D CAFEF00D CAFEF00D
0x20003A80: CAFEF00D CAFEF00D CAFEF00D CAFEF00D
0x20003A90: CAFEF00D CAFEF00D CAFEF00D CAFEF00D
0x20003AA0: CAFEF00D CAFEF00D CAFEF00D CAFEF00D
0x20003AB0: CAFEF00D CAFEF00D CAFEF00D CAFEF00D
0x20003AC0: CAFEF00D CAFEF00D CAFEF00D CAFEF00D
0x20003AD0: CAFEF00D CAFEF00D CAFEF00D CAFEF00D
0x20003AE0: CAFEF00D CAFEF00D CAFEF00D CAFEF00D
0x20003AF0: CAFEF00D CAFEF00D CAFEF00D CAFEF00D
0x20003B00: CAFEF00D CAFEF00D CAFEF00D CAFEF00D
0x20003B10: CAFEF00D CAFEF00D CAFEF00D CAFEF00D
0x20003B20: CAFEF00D CAFEF00D CAFEF00D CAFEF00D
0x20003B30: CAFEF00D CAFEF00D CAFEF00D CAFEF00D
0x20003B40: CAFEF00D CAFEF00D CAFEF00D CAFEF00D
0x20003B50: CAFEF00D CAFEF00D CAFEF00D CAFEF00D
0x20003B60: CAFEF00D CAFEF00D CAFEF00D CAFEF00D
0x20003B70: CAFEF00D CAFEF00D CAFEF00D CAFEF00D
0x20003B80: CAFEF00D CAFEF00D CAFEF00D CAFEF00D
0x20003B90: CAFEF00D CAFEF00D CAFEF00D CAFEF00D
0x20003BA0: CAFEF00D CAFEF00D CAFEF00D CAFEF00D
0x20003BB0: CAFEF00D CAFEF00D CAFEF00D CAFEF00D
0x20003BC0: CAFEF00D CAFEF00D CAFEF00D CAFEF00D
```

0x20003BD0: CAFEF00D CAFEF00D CAFEF00D CAFEF00D
0x20003BE0: CAFEF00D CAFEF00D CAFEF00D CAFEF00D
0x20003BF0: CAFEF00D CAFEF00D 00000000 CAFEF00D
0x20003C00: 00000004 20001D04 CAFEF00D FFFFEF68
0x20003C10: CAFEF00D 00001098 CAFEF00D CAFEF00D
0x20003C20: CAFEF00D CAFEF00D 00001006 200018D8
0x20003C30: 00000001 200018D8 20001C50 00000004
0x20003C40: 20001BB0 000134A5 0000100D 20001D28
0x20003C50: 00000006 00000006 20001C38 20001D44
0x20003C60: 20001C6C 20001D44 00000006 00000005
0x20003C70: 20001D38 00000005 20001D38 00000000
0x20003C80: 00000001 00012083 200018C8 000013D3
0x20003C90: 00550000 00000001 80E80000 4FC40000
0x20003CA0: 000080E8 00000009 60900000 000080E8
0x20003CB0: 60140000 20002764 0009608F 000080E8
0x20003CC0: 80000000 000080E8 00000000 00129F5F
0x20003CD0: 00000000 0001E4D9 80E80000 200018C8
0x20003CE0: 200018D4 00000000 80E80000 000000FF
0x20003CF0: 0000011C 0001BCE1 0000203A 0001BC1D
0x20003D00: 00000000 0001BC1D 80E80000 0001BCE1
0x20003D10: 0000011C 0001BDA9 80E80000 0001BDA9
0x20003D20: 0000011C FFFFFFFF9 008B8000 0001BC1D
0x20003D30: 00000048 00000010 0000A000 00000009
0x20003D40: 0001E326 00000001 80E80000 51538000
0x20003D50: 000080E8 0001E9CF 00000000 00000009
0x20003D60: 61C78000 000080E8 00000048 00000504
0x20003D70: 0000A1FC 0002125C 00000000 000080E8
0x20003D80: 00000000 0012A236 00000000 0001E4D9
0x20003D90: 000080E8 00000009 00004998 000080E8
0x20003DA0: 622C8000 0012A29B 00000042 0001E479
0x20003DB0: 40011000 000185EF 00006E10 00000000
0x20003DC0: 00000000 00000004 0000000C 00000000
0x20003DD0: 62780000 00018579 2000311B 0001ACDF
0x20003DE0: 00000000 20003054 20002050 00000001
0x20003DF0: 20003DF8 0002085D 00000001 200030D4
0x20003E00: 00000200 0001F663 00000001 200030D4
0x20003E10: 00000001 2000311B 0001F631 00020A6D
0x20003E20: 00000001 00000000 0000000C 200030D4
0x20003E30: 2000311B 00000042 200030D4 00020AD7
0x20003E40: 20002050 200030D4 20002050 00020833
0x20003E50: 20002050 20003F1B 20002050 0001FF89
0x20003E60: 20002050 0001FFA3 00000005 20003ED8
0x20003E70: 20002050 0001FF8B 00000010 00020491
0x20003E80: 00000001 0012A54E 00000020 00022409
0x20003E90: 00000000 20002050 200030D4 0001FF8B
0x20003EA0: 00021263 00000005 0000000C 20003F74
0x20003EB0: 20003ED8 20002050 200030D4 00020187
0x20003EC0: 20003ED4 20003054 00000000 20003F75
0x20003ED0: 00000008 20003F64 00000084 FFFFFFFF
0x20003EE0: FFFFFFFF 00000008 00000001 00000008
0x20003EF0: 20302058 2000311B 0001F631 00020A6D
0x20003F00: 20002050 00000000 0000000C 200030D4
0x20003F10: 32002050 32303032 00323330 000258D7
0x20003F20: 20002050 200030D4 20002050 00020833
0x20003F30: 00000000 20002050 00000020 000001CE
0x20003F40: 20003F40 200030D4 00000004 0001ED83
0x20003F50: 200030D4 20003F60 000001D6 000001D7
0x20003F60: 000001D8 00016559 0000000C 00000000
0x20003F70: 6C383025 00000058 200030D4 FFFFFFFF
0x20003F80: 1FFF4000 00000028 00000028 000217F8
0x20003F90: 200020C7 000166C5 000166AD 00017ED9
0x20003FA0: FFFFFFFF 200020B8 2000306C 200030D4
0x20003FB0: 200020B4 000180AD 1FFF4000 200020B0
0x20003FC0: 200020B0 200020B0 1FFF4000 0001A63D
0x20003FD0: CAFEF00D CAFEF00D 200020B4 00000002
0x20003FE0: FFFFFFFF FFFFFFFF 1FFF4000 00000000
0x20003FF0: 00000000 00000000 00000000 00016113
OK

History

This page tracks additions or changes to the AT command set based on the firmware version number (which you can obtain via the 'ATI' command):

Version 0.7.7

The following AT commands and features were added in the 0.7.7 release:

- Added AT+BLEUARTTXF (F for force) to immediately send the specified data out in an BLE UART packet (max 20 bytes), bypassing any FIFO delays and avoiding packets potentially being transmitted in two transactions.
- Adjusted BLE UART service to use min connection interval as the tx interval
- Added AT+DFUIRQ to enable using the DFU Pin for IRQ purposes when there is a supported event on the nRF51822
- Enabled the internal pullup resistor on the CS pin for Bluefruit SPI boards
- Added AT+MODESWITCHEN to enable/disable +++ mode switching from the local (serial or SPI) or BLE UART side. By default local = enabled, ble = disabled, meaning commands can only be executed via the local interface by default.
- Implemented a '\+' escape code to immediately send '+' chars without trigger the +++ delay waiting for further similar input
- Added AT+BLEHIDGAMEPADEN to separately enable HID Gamepad, since iOS/OSX has a conflict with gamepad devices causing HID keyboard to not work properly.

The following bugs were fixed in release 0.7.7:

- Fixed a factory reset issue when a long delay occurs in app_error_handler()
- Fixed an issue where strings were being truncated at 64 chars in UART
- Fixed HID keyboard support not working with iOS 9 & 10

Version 0.7.0

The following AT commands were added in the 0.7.0 release:

- AT+BAUDRATE
Change the HW UART baudrate

- AT+UARTFLOW
Enable or disable HW UART flow control
- AT+BLEMIDIEN=on/off/0/1
Enable/disable MIDI service, requires a reset to take effect
- AT+BLEMIDITX
Send a MIDI event
- AT+BLEMIDIRX
Receive an available MIDI event
- AT+GATTCHARRAW
Added this read only command to read binary (instead of ASCII) data from a characteristic. It is non-printable but less overhead and easier for writing library in Arduino
- AT+NVMWRITE=offset,datatype,data
Writes data to 256 byte user NVM. Datatype must be STRING (1), BYTEARRAY (2), or INTEGER (3)
- AT+NVMREAD=offset,size,datatype
Reads data back from 256 bytes user NVM
- AT+NVMREADRAW=offset,size binary data
Binary data (instead of ASCII) is returned, ending with "OK\r\n". It is non-printable but less overhead and easier to use in some situations.
- AT+BLEHIDGAMEPAD=x,y,buttons
 - X is LEFT, RIGHT: X=-1 LEFT is pressed, X=1 RIGHT is pressed, X=0 no pressed
 - Y is UP, DOWN: Y=-1 i UP, Y=1 is DOWN, Y=0 no pressed
 - Button [0x00-0xFF] is a bit mask for 8 button 0-7
- AT+GAPCONNECTABLE=on/off/1/0
Allow/disallow connection to the device
- AT+EDDYSTONESERVICEEN
Add/remove EddyStone service to GATT table (requires reset)
- AT+EDDYSTONEBROADCAST=on/off/0/1
Start/stop broadcasting url using settings from NVM
- AT+BLEBATTEN=on/off/1/0
Enable battery service. Reset required due to the service change.
- AT+BLEBATTVAL=percent
Updates the Battery level, percent is 0 to 100

The following commands were changed in the 0.7.0 release:

- AT+GATTADDCHAR
 - Added a DATATYPE option to indicate the data type for the GATT characteristic's payload. Valid options are: AUTO (0, default), STRING (1), BYTEARRAY (2), INTEGER (3)
 - Added characteristic user description option via the DESCRIPTION flag
 - Added characteristic presentation format support via the PRESENTATION flag
- AT+GAPINTERVALS

Added a new 'adv_lowpower_interval' parameter, default value is 417.5 ms. Current arguments are now: min_conn, max_conn, adv_interval, adv_timeout, adv_lowpower_interval

Key bug fixes and changes in this release:

- Significant BTLE UART speed and reliability improvements
- Added callback support (work in progress) for:
 - BLE UART RX
 - GATT Characteristic(s) RX
 - MIDI RX
 - Connect/Disconnect
- Increased MAX_LEN for each characteristic from 20 to 32 bytes
- Changed the default GAP parameters:
 - Advertising interval = 20ms
 - Min connection interval = 20 ms
 - Max connection interval = 40 ms
- Increased the maximum number of CCCDs saved to flash from 8 to 16
- Eddystone config service disabled by default
- Removed AT+EDDYSTONEENABLE to avoid confusion
- Changed advertising timeout for Eddystone to 'unlimited'
- Fixed Write-No-Response characteristic property, which wasn't being handled properly
- Fixed timing constraints to meet Apple design guidelines
- Fixed systick to ms calculation
- Fixed all tests with google eddystone validator except for writing tx_power = 1 dB (not valid on nrf51)

- Fixed a bug where writing from the central does not update the value on the characteristic correctly
- Fixed an issue with HID examples, where when paired with Central, a disconnect then reconnect could not send HID reports anymore

Version 0.6.7

The following AT commands were added in the 0.6.7 release:

- **AT+BLEUARTFIFO**
Returns the number of free bytes available in the TX and RX FIFOs for the Bluetooth UART Service.

The following commands were changed in the 0.6.7 release:

- **AT+BLEUARTTX**
If the TX FIFO is full, the command will wait up to 200ms to see if the FIFO size decreases before exiting and returning an ERROR response due to the FIFO being full.
- **AT+BLEURIBEACON**
This command will go back to using the old (deprecated) UriBeacon UUID (0xFED8), and only the AT+EDDYSTONEURL command will use the newer Eddystone UUID (0xFEAA).
- **AT+BLEKEYBOARD** and **AT+BLEUARTTX**
These commands now accept '\?' as an escape code since 'AT+BLEKEYBOARD=?' has another meaning for the AT parser. To send a single question mark the following command should be used: 'AT+BLEKEYBOARD=\?' or 'AT+BLEUARTTX=\?'
- **AT+EDDYSTONEURL**
This command now accepts an optional third parameter for RSSI at 0m value (default is -18dBm).
Running this command with no parameters ('AT+EDDYSTONEURL\r\n') will now return the current URL.

Key bug fixes in this release:

- The FIFO handling for the Bluetooth UART Service was improved for speed and stability, and the TX and RF FIFOs were increased to 1024 bytes each.

- An issue where a timer overflow was causing factory resets every 4 hours or so has been resolved.
- Fixed a problem with the GATT server where 'value_len' was being incorrectly parsed for integer values in characteristics where 'max_len' >4

Version 0.6.6

The following AT commands were added in the 0.6.6 release:

- AT+EDDYSTONEURL
Update the URL for the beacon and switch to beacon mode
- AT+EDDYSTONEENABLE
Enable/disable beacon mode using the configured url
- AT+EDDYSTONECONFIGEN
Enable advertising for the the Eddystone configuration service for the specified number of seconds
- AT+HWMODELED
Allows the user to override the default MODE LED behaviour with one of the following options: DISABLE, MODE, HWUART, BLEUART, SPI, MANUAL
- AT+BLECONTROLKEY
Allows HID media control values to be sent to a bonded central device (volume, screen brightness, etc.)
- AT+BLEHIDEN
Enables or disables BLE HID support in the Bluefruit LE firmware (mouse, keyboard and media control)
- AT+BLEMOUSEMOVE
To move the HID mouse
- AT+BLEMOUSEBUTTON
To set the state of the HID mouse buttons

The following commands were changed in the 0.6.6 release:

- AT+BLEKEYBOARDEN - Now an alias for AT+BLEHIDEN
- AT+GATTADDCHAR - Added a new UUID128 field to allow custom UUIDs

Key bug fixes in this release:

- Fixed issues with long beacon URLs
- Fixed big endian issue in at+blebeacon for major & minor number

Known issues with this release:

- Windows 10 seems to support a limited number of characteristics for the DIS service. We had to disable the Serial Number characteristic to enable HID support with windows 10.

Version 0.6.5

The following AT commands were added in the 0.6.5 release:

- [AT+BLEGETPEERADDR](https://adafru.it/iCq) (<https://adafru.it/iCq>)

The following commands were changed in the 0.6.5 release:

- Increased the UART buffer size (on the nRF51) from 128 to 256 bytes
- +++ now responds with the current operating mode
- Fixed a bug with AT+GATTCHAR values sometimes not being saved to NVM
- Fixed a bug with AT+GATTCHAR max_len value not being taken into account after a reset (min_len was always used when repopulating the value)

Version 0.6.2

This is the first release targetting 32KB SRAM parts (QFAC). 16KB SRAM parts can't be used with this firmware due to memory management issues, and should use the earlier 0.5.0 firmware.

The following AT commands were changed in the 0.6.2 release:

- [AT+BLEUARTTX](https://adafru.it/iCr) (<https://adafru.it/iCr>)
Basic escape codes were added for new lines, tabs and backspace
- [AT+BLEKEYBOARD](https://adafru.it/iCr) (<https://adafru.it/iCr>)
Also works with OS X now, and may function with other operating systems that support BLE HID keyboards

Version 0.5.0

The following AT commands were added in the 0.5.0 release:

- [AT+BLEKEYBOARDEN](https://adafru.it/iCr) (<https://adafru.it/iCr>)
- [AT+BLEKEYBOARD](https://adafru.it/iCr) (<https://adafru.it/iCr>)
- [AT+BLEKEYBOARDCODE](https://adafru.it/iCr) (<https://adafru.it/iCr>)

The following AT commands were changed in the 0.5.0 release:

- [ATI](https://adafru.it/iCs) (<https://adafru.it/iCs>)
The SoftDevice, SoftDevice version and bootloader version were added as a new (7th) record. For Ex: "S110 7.1.0, 0.0" indicates version 7.1.0 of the S110 softdevice is used with the 0.0 bootloader (future boards will use a newer 0.1 bootloader).

Other notes concerning 0.5.0:

Starting with version 0.5.0, you can execute the AT+FACTORYRESET command at any point (and without a terminal emulator) by holding the DFU button down for 10 seconds until the blue CONNECTED LED starts flashing, then releasing it.

Version 0.4.7

The following AT commands were added in the 0.4.7 release:

- [+++](https://adafru.it/iCs) (<https://adafru.it/iCs>)
- [AT+HWRANDOM](https://adafru.it/iCt) (<https://adafru.it/iCt>)
- [AT+BLEURIBEACON](https://adafru.it/iCu) (<https://adafru.it/iCu>)
- [AT+DBGSTACKSIZE](https://adafru.it/iCv) (<https://adafru.it/iCv>)
- [AT+DBGSTACKDUMP](https://adafru.it/iCv) (<https://adafru.it/iCv>)

The following commands were changed in the 0.4.7 release:

- [ATI](https://adafru.it/iCs) (<https://adafru.it/iCs>) The chip revision was added after the chip name. Whereas

ATI would previously report 'nRF51822', it will now add the specific HW revision if it can be detected (ex 'nRF51822 QFAAG00')

Version 0.3.0

- First public release
-

Command Examples

The following code snippets can be used when operating in Command Mode to perform specific tasks.

Heart Rate Monitor Service

The command list below will add a [Heart Rate](https://adafru.it/ddB) service to the BLEFriend's attribute table, with two characteristics:

- [Heart Rate Measurement](https://adafru.it/ddD)
- [Body Sensor Location](https://adafru.it/eck)

```
# Perform a factory reset to make sure we get a clean start
AT+FACTORYRESET
OK

# Add the Heart Rate service entry
AT+GATTADDSERVICE=UUID=0x180D
1
OK

# Add the Heart Rate Measurement characteristic
AT+GATTADDCHAR=UUID=0x2A37, PROPERTIES=0x10, MIN_LEN=2, MAX_LEN=3, VALUE=00-40
1
OK

# Add the Body Sensor Location characteristic
AT+GATTADDCHAR=UUID=0x2A38, PROPERTIES=0x02, MIN_LEN=1, VALUE=3
2
OK

# Create a custom advertising packet that includes the Heart Rate service UUID
AT+GAPSETADVDATA=02-01-06-05-02-0d-18-0a-18
OK

# Reset the device to start advertising with the custom payload
ATZ
OK

# Update the value of the heart rate measurement (set it to 0x004A)
```

```
AT+GATTCHAR=1,00-4A
OK
```

Python Script

The following code performs the same function, but has been placed inside a Python wrapper using [PySerial \(https://adafru.it/cLU\)](https://adafru.it/cLU) to show how you can script actions for the AT parser.

```
import io
import sys
import serial
import random
from time import sleep

filename = "hrm.py"
ser = None
serio = None
verbose = True # Set this to True to see all of the incoming serial data

def usage():
    """Displays information on the command-line parameters for this script"""
    print "Usage: " + filename + " <serialPort>\n"
    print "For example:\n"
    print "  Windows : " + filename + " COM14"
    print "  OS X    : " + filename + " /dev/tty.usbserial-DN009WN0"
    print "  Linux   : " + filename + " /dev/ttyACM0"
    return

def checkargs():
    """Validates the command-line arguments for this script"""
    if len(sys.argv) < 2:
        print "ERROR: Missing serialPort"
        usage()
        sys.exit(-1)
    if len(sys.argv) > 2:
        print "ERROR: Too many arguments (expected 1)."
        usage()
        sys.exit(-2)

def errorhandler(err, exitonerror=True):
    """Display an error message and exit gracefully on "ERROR\r\n" responses"""
    print "ERROR: " + err.message
    if exitonerror:
        ser.close()
        sys.exit(-3)

def atcommand(command, delays=0):
    """Executes the supplied AT command and waits for a valid response"""
    serio.write(unicode(command + "\n"))
    if delays:
        sleep(delays/1000)
    rx = None
    while rx != "OK\r\n" and rx != "ERROR\r\n":
        rx = serio.readline(2000)
        if verbose:
            print unicode(rx.rstrip("\r\n"))
    # Check the return value
```

```

if rx == "ERROR\r\n":
    raise ValueError("AT Parser reported an error on '" + command.rstrip() +
    "'")

if __name__ == '__main__':
    # Make sure we received a single argument (comPort)
    checkargs()

    # This will automatically open the serial port (no need for ser.open)
    ser = serial.Serial(port=sys.argv[1], baudrate=9600, rtscts=True)
    serio = io.TextIOWrapper(io.BufferedRWPair(ser, ser, 1),
                             newline='\r\n',
                             line_buffering=True)

    # Add the HRM service and characteristic definitions
    try:
        atcommand("AT+FACTORYRESET", 1000) # Wait 1s for this to complete
        atcommand("AT+GATTCLEAR")
        atcommand("AT+GATTADDSERVICE=UUID=0x180D")
        atcommand("AT+GATTADDCHAR=UUID=0x2A37, PROPERTIES=0x10, MIN_LEN=2,
MAX_LEN=3, VALUE=00-40")
        atcommand("AT+GATTADDCHAR=UUID=0x2A38, PROPERTIES=0x02, MIN_LEN=1, VALUE=3")
        atcommand("AT+GAPSETADVDATA=02-01-06-05-02-0d-18-0a-18")
        # Perform a system reset and wait 1s to come back online
        atcommand("ATZ", 1000)
        # Update the value every second
        while True:
            atcommand("AT+GATTCHAR=1,00-%02X" % random.randint(50, 100), 1000)
    except ValueError as err:
        # One of the commands above returned "ERROR\r\n"
        errorhandler(err)
    except KeyboardInterrupt:
        # Close gracefully on CTRL+C
        ser.close()
        sys.exit()

```

The results of this script can be seen below in the 'HRM' app of Nordic's nRF Toolbox application:

Please note that nRF Toolbox will only display HRM data if the value changes, so you will need to update the Heart Rate Measurement characteristic at least once after opening the HRM app and connecting to the BLEFriend

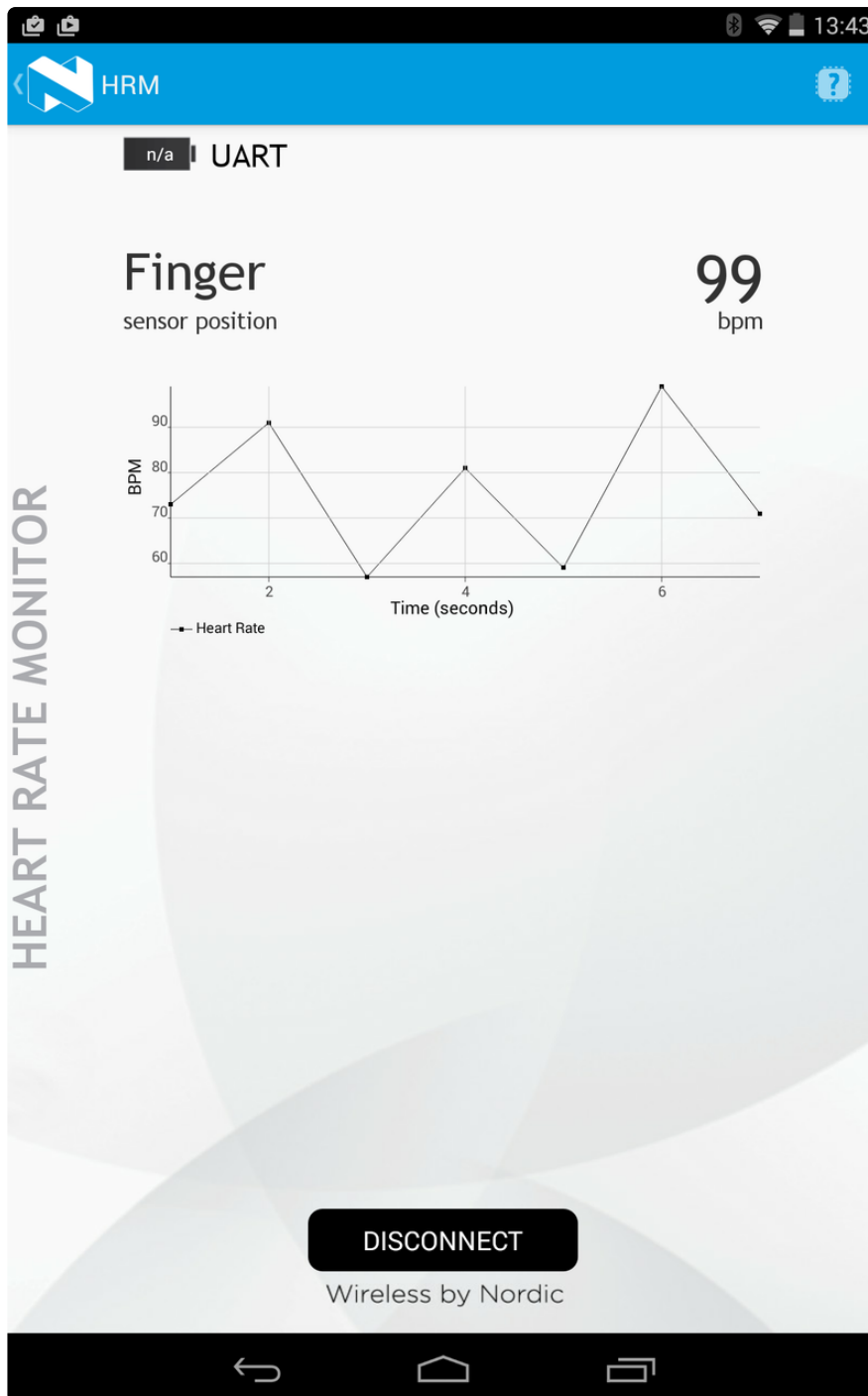

SDEP (SPI Data Transport)

In order to facilitate switching between UART and SPI based Bluefruit LE modules, the Bluefruit LE SPI Friend and Shield uses the same AT command set at the UART modules (`ATI` , `AT+HELP` , etc.).

These text-based AT commands are encoded as binary messages using a simple binary protocol we've named SDEP (Simple Data Exchange Protocol).

Most of the time, you never need to deal with SDEP directly, but we've documented the protocol here in case you need understand the Bluefruit LE SPI interface in depth!

SDEP Overview

SDEP was designed as a bus neutral protocol to handle binary commands and responses -- including error responses -- in a standard, easy to extend manner. 'Bus neutral' means that we can use SDEP regardless of the transport mechanism (USB HID, SPI, I2C, Wireless data over the air, etc.).

All SDEP messages have a four byte header, and in the case of the Bluefruit LE modules up to a 16 byte payloads. Larger messages are broken up into several 4+16 bytes message chunks which are rebuilt at either end of the transport bus. The 20 byte limit (4 byte header + 16 byte payload) was chosen to take into account the maximum packet size in Bluetooth Low Energy 4.0 (20 bytes per packet).

SPI Setup

While SDEP is bus neutral, in the case of the Bluefruit LE SPI Friend or Shield, an SPI transport is used with the following constraints and assumptions, largely to take into account the HW limitations of the nRF51822 system on chip:

SPI Hardware Requirements

- The SPI clock should run $\leq 4\text{MHz}$
- A 100us delay should be added between the moment that the CS line is asserted, and before any data is transmitted on the SPI bus
- The CS line must remain asserted for the entire packet, rather than toggling CS every byte
- The CS line can however be deasserted and then reasserted between individual SDEP packets (of up to 20 bytes each).
- The SPI commands must be setup to transmit MSB (most significant bit (<https://adafruit.it/pBP>)) first (not LSB first)

IRQ Pin

The IRQ line is asserted by the Bluefruit LE SPI Friend/Shield as long as an entire SDEP packet is available in the buffer on the nRF51822, at which point you should read the packet, keeping the CS line asserted for the entire transaction (as detailed above).

The IRQ line will remain asserted as long as one or more packets are available, so the line may stay high after reading a packet, meaning that more packets are still available in the FIFO on the SPI secondary side.

SDEP Packet and SPI Error Identifier

Once CS has been asserted and the mandatory 100us delay has passed, a single byte should be read from the SPI bus which will indicate the type of payload available on the nRF51822 (see Message Type Indicator below for more information on SDEP message types). Keep CS asserted after this byte has been read in case you need to continue reading the rest of the frame.

If a standard SDEP message type indicator (0x10, 0x20, 0x40 or 0x80) is encountered, keep reading as normal. There are two other indicators that should be taken into account, though, which indicate a problem on the nRF51822 SPI secondary side:

- 0xFE: Secondary device not ready (wait a bit and try again)
- 0xFF: Secondary device read overflow indicator (you've read more data than is available)

This means there are six possible response bytes reading the message type indicator (the first byte read after an SDEP command is sent): 0x10, 0x20, 0x40, 0x80, which indicate a valid message type, or 0xFE, 0xFF which indicate an error condition.

Sample Transaction

The following image shows a sample SDEP response that is spread over two packets (since the response is > 20 bytes in size). Notice that the IRQ line stays asserted between the packets since more than one packet was available in the FIFO on the Bluefruit LE SPI side:

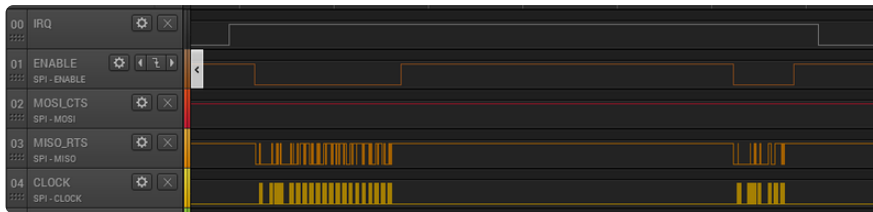

SDEP (Simple Data Exchange Protocol)

The Simple Data Exchange Protocol (SDEP) can be used to send and receive binary messages between two connected devices using any binary serial bus (USB HID, USB Bulk, SPI, I2C, Wireless, etc.), exchanging data using one of four distinct message types (Command, Response, Alert and Error messages).

The protocol is designed to be flexible and extensible, with the only requirement being that individual messages are 20 bytes or smaller, and that the first byte of every message is a one byte (U8) identifier that indicates the message type, which defines the format for the remainder of the payload.

Endianness

All values larger than 8-bits are encoded in little endian format. Any deviation from this rule should be clearly documented.

Message Type Indicator

The first byte of every message is an 8-bit identifier called the Message Type Indicator. This value indicates the type of message being sent, and allows us to determine the format for the remainder of the message.

Message Type	ID (U8)
Command	0x10
Response	0x20
Alert	0x40
Error	0x80

SDEP Data Transactions

Either connected device can initiate SDEP transactions, though certain transport protocols imposes restrictions on who can initiate a transfer. The main device, for example, always initiates transactions with Bluetooth Low Energy or USB, meaning that secondary devices can only reply to incoming commands.

Every device that receives a Command Message must reply with a Response Message, Error Message or Alert message.

Message Types

Command Messages

Command messages (Message Type = 0x10) have the following structure:

Name	Type	Meaning
Message Type	U8	Always '0x10'
Command ID	U16	Unique Command Identifier
Payload Length	U8	[7] More data [6-5] Reserved [4-0] Payload length (0..16)
Payload	...	Optional command payload (parameters, etc.)

Command ID (bytes 1-2) and Payload Length (byte 3) are mandatory in any command message. The message payload is optional, and will be ignored if Payload Length is set to 0 bytes. When a message payload is present, it's length can be anywhere from 1..16 bytes, to stay within the 20-byte maximum message length.

A long command (>16 bytes payload) must be divided into multiple packets. To facilitate this, the More data field (bit 7 of byte 3) is used to indicate whether additional packets are available for the same command. The SDEP receiver must continue to reads packets until it finds a packet with More data == 0, then assemble all sub-packets into one command if necessary.

The contents of the payload are user defined, and can change from one command to another.

A sample command message would be:

10 34 12 01 FF		
0: Message Type (U8)	0x10	
1+2: Command ID (U16)	0x34 0x12	
3: Payload Len (U8)	0x01	
4: Payload (...)	0xFF	

- The first byte is the Message Type (0x10), which identifies this as a command message.
- The second and third bytes are 0x1234 (34 12 in little-endian notation), which is the unique command ID. This value will be compared against the command lookup table and redirected to an appropriate command handler function if a matching entry was found.
- The fourth byte indicates that we have a message payload of 1 byte
- The fifth byte is the 1 byte payload: 0xFF

Response Messages

Response messages (Message Type = 0x20) are generated in response to an incoming command, and have the following structure:

Name	Type	Meaning
Message Type	U8	Always '0x20'
Command ID	U16	Command ID this message is a response to
Payload Length	U8	[7] More data [6-5] Reserved [4-0] Payload length (0..16)
Payload		Optional response payload (parameters, etc.)

By including the Command ID that this response message is related to, the recipient can more easily correlate responses and commands. This is useful in situations where multiple commands are sent, and some commands may take a longer period of time to execute than subsequent commands with a different command ID.

Response messages can only be generated in response to a command message, so the Command ID field should always be present.

A long response (>16 bytes payload) must be divided into multiple packets. Similar to long commands, the More data field (bit 7 of byte 3) is used to indicate whether additional packets are available for the same response. On responses that span more than one packet, the More data bit on the final packet will be set to 0 to indicate that this is the last packet in the sequence. The SDEP receiver must re-assemble all sub-packets into one payload when necessary.

If more precise command/response correlation is required a custom protocol should be developed, where a unique message identifier is included in the payload of each command/response, but this is beyond the scope of this high-level protocol definition.

A sample response message would be:

```
20 34 12 01 FF
```

0: Message Type (U8)	0x20	
1+2: Command ID (U16)	0x34 0x12	
3: Payload Len (U8)	0x01	
4: Payload	0xFF	

- The first byte is the Message Type (0x20), which identifies this as a response message.
- The second and third bytes are 0x1234, which is the unique command ID that this response is related to.
- The fourth byte indicates that we have a message payload of 1 byte.
- The fifth byte is the 1 byte payload: 0xFF

Alert Messages

Alert messages (Message Type = 0x40) are sent whenever an alert condition is present on the system (low battery, etc.), and have the following structure:

Name	Type	Meaning
Message Type	U8	Always '0x40'
Alert ID	U16	Unique ID for the Alert Condition
Payload Length	U8	Payload Length (0..16)
Payload	...	Optional response payload

A sample alert message would be:

```
40 CD AB 04 42 07 00 10
```

0: Message Type (U8)	0x40	
1+2: Alert ID (U16)	0xCD 0xAB	
3: Payload Length	0x04	
4+5+6+7: Payload	0x42 0x07 0x00 0x10	

- The first byte is the Message Type (0x40), which identifies this as an alert message.
- The second and third bytes are 0xABCD, which is the unique alert ID.
- The fourth byte indicates that we have a message payload of 4 bytes.
- The last four bytes are the actual payload: 0x10000742 in this case, assuming we were transmitting a 32-bit value in little-endian format.

Standard Alert IDs

Alert IDs in the range of 0x0000 to 0x00FF are reserved for standard SDEP alerts, and may not be used by custom alerts.

The following alerts have been defined as a standard part of the protocol:

ID	Alert	Description
0x0000	Reserved	Reserved for future use
0x0001	System Reset	The system is about to reset
0x0002	Battery Low	The battery level is low
0x0003	Battery Critical	The battery level is critically low

Error Messages

Error messages (Message Type = 0x80) are returned whenever an error condition is present on the system, and have the following structure:

Name	Type	Meaning
Message Type	U8	Always '0x80'
Error ID	U16	Unique ID for the error condition
Reserved	U8	Reserved for future use

Whenever an error condition is present and the system needs to be alerted (such as a failed request, an attempt to access a non-existing resource, etc.) the system can return a specific error message with an appropriate Error ID.

A sample error message would be:

```
80 01 00 00
```

0: Message ID (U8)	0x80	
1+2: Error ID (U16)	0x01 0x00	
3: Reserved (U8)	0x00	

Standard Error IDs

Error IDs in the range of 0x0000 to 0x00FF are reserved for standard SDEP errors, and may not be used by custom errors.

The following errors have been defined as a standard part of the protocol:

ID	Error	Description
0x0000	Reserved	Reserved for future use
0x0001	Invalid CMD ID	CMD ID wasn't found in the lookup table
0x0003	Invalid Payload	The message payload was invalid

Existing Commands

At present, there are only four SDEP commands implemented in the Bluefruit SPIFRIEND32 firmware:

- SDEP_CMDTYPE_INITIALIZE = 0xBEEF
- SDEP_CMDTYPE_AT_WRAPPER = 0x0A00
- SDEP_CMDTYPE_BLE_UARTTX = 0x0A01
- SDEP_CMDTYPE_BLE_UARTRX = 0x0A02

SDEP_CMDTYPE_INITIALIZE can be used to reset the SDEP system when a HW RST line isn't available.

The two SDEP_CMDTYPE_UART* commands send data over the BLE UART service.

SDEP_CMDTYPE_AT_WRAPPER is the command you will use most of the time, which is a wrapper that sends AT commands over the binary SDEP transport. This isn't terribly efficient, and a binary mechanism would have taken less bytes per command, but it allows the reuse of all of the earlier AT parser commands without having to implement one wrapper for every command which would significantly increase the overall code size.

SDEP AT Wrapper Usage

To use the SDEP AT Wrapp you simply send the correct header, along with the AT command you which to send to the parser. For example:

```
10-00-0A-03- 'a' - 't' - 'I'
```

- Message Type: 0x10 (Command)
- Command ID: 0x0A00
- Command Payload Length: 3 bytes
- Command Payload: 'a' + 't' + 'i'

This will cause the ATi command to be executed, which will return basic system information.

GATT Service Details

Data in Bluetooth Low Energy is organized around units called '[GATT Services \(https://adafru.it/iCp\)](https://adafru.it/iCp)' and 'GATT Characteristics'. To expose data to another device, you must instantiate at least one service on your device.

Adafruit's Bluefruit LE Pro modules support some 'standard' services, described below (more may be added in the future).

UART Service

The UART Service is the standard means of sending and receiving data between connected devices, and simulates a familiar two-line UART interface (one line to transmit data, another to receive it).

The service is described in detail on the dedicated [UART Service \(https://adafru.it/iCn\)](https://adafru.it/iCn) page.

UART Service

Base UUID: 6E400001-B5A3-F393-E0A9-E50E24DCCA9E

This service simulates a basic UART connection over two lines, TXD and RXD.

It is based on a proprietary UART service specification by Nordic Semiconductors. Data sent to and from this service can be viewed using the nRFUART apps from Nordic Semiconductors for Android and iOS.

This service is available on every Bluefruit LE module and is automatically started during the power-up sequence.

Characteristics

Nordic's UART Service includes the following characteristics:

Name	Mandatory	UUID	Type	R	W	N	I
TX	Yes	0x0002	U8[20]		X		
RX	Yes	0x0003	U8[20]	X		X	

R = Read; W = Write; N = Notify; I = Indicate

Characteristic names are assigned from the point of view of the Central device

TX (0x0002)

This characteristic is used to send data back to the sensor node, and can be written to by the connected Central device (the mobile phone, tablet, etc.).

RX (0x0003)

This characteristic is used to send data out to the connected Central device. Notify can be enabled by the connected device so that an alert is raised every time the TX channel is updated.

Software Resources

To help you get your Bluefruit LE module talking to other Central devices, we've put together a number of open source tools for most of the major platforms supporting Bluetooth Low Energy.

Bluefruit LE Client Apps and Libraries

Adafruit has put together the following mobile or desktop apps and libraries to make it as easy as possible to get your Bluefruit LE module talking to your mobile device or laptop, with full source available where possible:

[Bluefruit LE Connect \(https://adafru.it/f4G\)](https://adafru.it/f4G) (Android/Java)

Bluetooth Low Energy support was added to Android starting with Android 4.3 (though it was only really stable starting with 4.4), and we've already released [Bluefruit LE Connect to the Play Store \(https://adafru.it/f4G\)](https://adafru.it/f4G).

The full [source code \(https://adafru.it/fY9\)](https://adafru.it/fY9) for Bluefruit LE Connect for Android is also available on Github to help you get started with your own Android apps. You'll need a recent version of [Android Studio \(https://adafru.it/fYa\)](https://adafru.it/fYa) to use this project.



Adafruit Bluefruit LE Connect

Adafruit Industries Education

★★★★★ 47

PEGI 3

This app is compatible with some of your devices.

Installed

[Bluefruit LE Connect \(https://adafru.it/f4H\)](https://adafru.it/f4H) (iOS/Swift)

Apple was very early to adopt Bluetooth Low Energy, and we also have an iOS version of the [Bluefruit LE Connect \(https://adafru.it/f4H\)](https://adafru.it/f4H) app available in Apple's app store.

The full swift source code for Bluefruit LE Connect for iOS is also available on Github. You'll need XCode and access to Apple's developer program to use this project:

- Version 1.x source code: https://github.com/adafruit/Bluefruit_LE_Connect (<https://adafru.it/ddv>)
- Version 2.x source code: https://github.com/adafruit/Bluefruit_LE_Connect_v2 (<https://adafru.it/o9E>)

Version 2.x of the app is a complete rewrite that includes iOS, OS X GUI and OS X command-line tools in a single codebase.

Adafruit Bluefruit LE Connect

[View More by This Developer](#)

By Adafruit Industries

Open iTunes to buy and download apps.



[View in iTunes](#)

This app is designed for both iPhone and iPad

Description

Wirelessly connect your iOS device to Adafruit Bluefruit LE modules for control & communication with your projects.

Features:

[Adafruit Industries Web Site](#) > [Adafruit Bluefruit LE Connect Support](#) >

[...More](#)

What's New in Version 1.7

- Apple Watch support with Color Picker and Control Pad
- Brightness Slider added to Color Picker
- Bugfixes for XML parsing in DFU mode

[Bluefruit LE Connect for OS X \(https://adafru.it/o9F\)](https://adafru.it/o9F) (Swift)

This OS X desktop application is based on the same V2.x codebase as the iOS app, and gives you access to BLE UART, basic Pin I/O and OTA DFU firmware updates from the convenience of your laptop or mac.

This is a great choice for logging sensor data locally and exporting it as a CSV, JSON or XML file for parsing in another application, and uses the native hardware on your computer so no BLE dongle is required on any recent mac.

The full source is also [available on Github \(https://adafru.it/o9E\)](https://adafru.it/o9E).

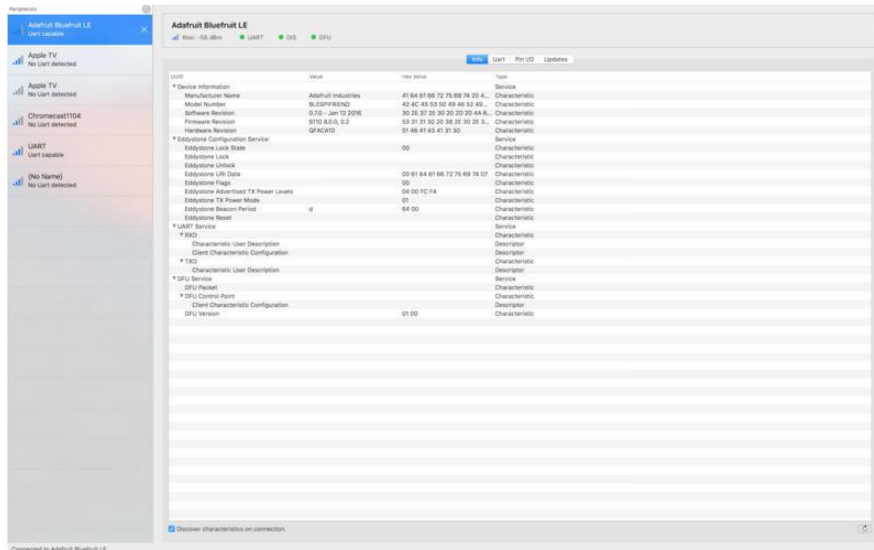

Bluefruit LE Command Line Updater for OS X (<https://adafru.it/pLF>) (Swift)

This experimental command line tool is unsupported and provided purely as a proof of concept, but can be used to allow firmware updates for Bluefruit devices from the command line.

This utility performs automatic firmware updates similar to the way that the GUI application does, by checking the firmware version on your Bluefruit device (via the Device Information Service), and comparing this against the firmware versions available online, downloading files in the background if appropriate.

Simply install the pre-compiled tool via the [DMG file \(https://adafru.it/pLF\)](https://adafru.it/pLF) and place it somewhere in the system path, or run the file locally via './bluefruit' to see the help menu:

```
$ ./bluefruit
bluefruit v0.3
Usage:
  bluefruit <command> [options...]

Commands:
  Scan peripherals:      scan
  Automatic update:    update [--enable-beta] [--uuid <uuid>]
  Custom firmware:     dfu --hex <filename> [--init <filename>] [--
  uuid <uuid>]
  Show this screen:    --help
  Show version:        --version

Options:
  --uuid <uuid>      If present the peripheral with that uuid is used. If not
  present a list of peripherals is displayed
  --enable-beta      If not present only stable versions are used

Short syntax:
  -u = --uuid, -b = --enable-beta, -h = --hex, -i = --init, -v = --version, -? =
  --help
```

Deprecated: [Bluefruit Buddy \(https://adafru.it/mCn\)](https://adafru.it/mCn) (OS X)

This native OS X application is a basic proof of concept app that allows you to connect to your Bluefruit LE module using most recent macbooks or iMacs. You can get basic information about the modules and use the UART service to send and receive data.

The full source for the application is available in the github repo at [Adafruit_BluefruitLE_OSX \(https://adafru.it/mCo\)](https://adafru.it/mCo).

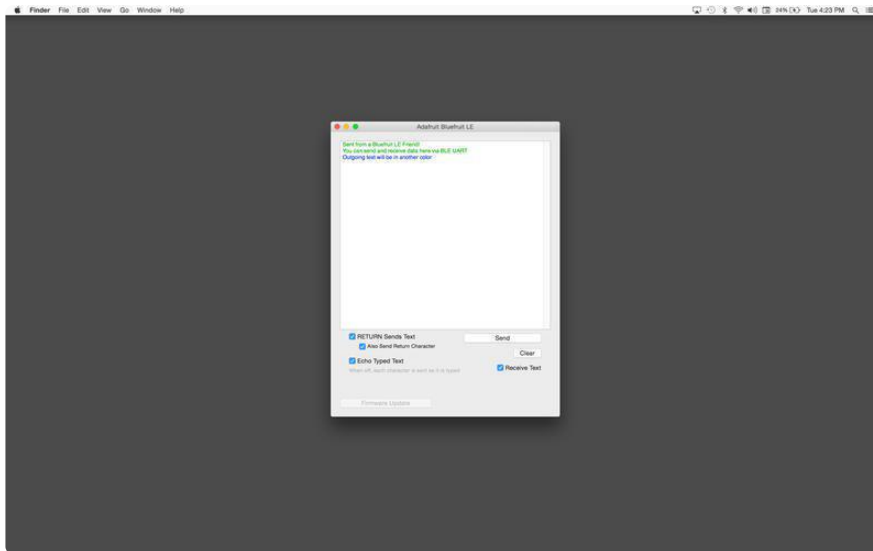

[ABLE \(https://adafru.it/ijB\)](https://adafru.it/ijB) (Cross Platform/Node+Electron)

[ABLE \(https://adafru.it/ijB\)](https://adafru.it/ijB) (Adafufruit Bluefruit LE Desktop) is a cross-platform desktop application based on Sandeep Misty's [noble library \(https://adafru.it/ijC\)](https://adafru.it/ijC) and the [Electron \(https://adafru.it/ijD\)](https://adafru.it/ijD) project from Github (used by Atom).

It runs on OS X, Windows 7+ and select flavours of Linux (Ubuntu tested locally).

Windows 7 support is particularly interesting since Windows 7 has no native support for Bluetooth Low Energy but the noble library talks directly to [supported Bluetooth 4.0 USB dongles \(http://adafru.it/1327\)](http://adafru.it/1327) to emulate BLE on the system (though at this stage it's still in early BETA and drops the connection and takes more care to work with).

This app allows you to collect sensor data or perform many of the same functionality offered by the mobile Bluefruit LE Connect apps, but on the desktop.

The app is still in BETA, but full [source \(https://adafru.it/ijE\)](https://adafru.it/ijE) is available in addition to the easy to use [pre-compiled binaries \(https://adafru.it/ijB\)](https://adafru.it/ijB).

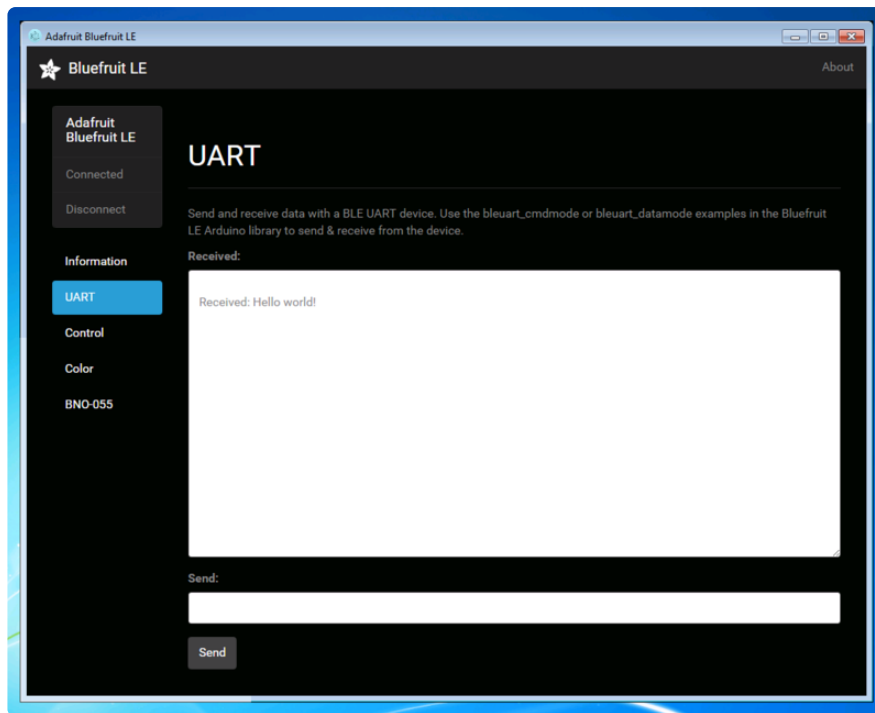

[Bluefruit LE Python Wrapper \(https://adafru.it/fQF\)](https://adafru.it/fQF)

As a proof of concept, we've played around a bit with getting Python working with the native Bluetooth APIs on OS X and the latest version of Bluez on certain Linux targets.

There are currently example sketches showing how to retrieve BLE UART data as well as some basic details from the Device Information Service (DIS).

This isn't an actively support project and was more of an experiment, but if you have a recent Macbook or a Raspberry Pi and know Python, you might want to look at [Adafruit_Python_BluefruitLE](https://adafru.it/fQF) (<https://adafru.it/fQF>) in our github account.

Debug Tools

If your sense of adventure gets the better of you, and your Bluefruit LE module goes off into the weeds, the following tools might be useful to get it back from unknown lands.

These debug tools are provided purely as a convenience for advanced users for device recovery purposes, and are not recommended unless you're OK with potentially bricking your board. Use them at your own risk.

[AdaLink \(https://adafru.it/fPq\)](https://adafru.it/fPq) (Python)

This command line tool is a python-based wrapper for programming ARM MCUs using either a [Segger J-Link \(https://adafru.it/fYU\)](https://adafru.it/fYU) or an [STLink/V2 \(https://adafru.it/ijF\)](https://adafru.it/ijF). You can use it to reflash your Bluefruit LE module using the latest firmware from the [Bluefruit LE firmware repo \(https://adafru.it/edX\)](https://adafru.it/edX).

Details on how to use the tool are available in the readme.md file on the main [Adafruit_AdaLink \(https://adafru.it/fPq\)](https://adafru.it/fPq) repo on Github.

Completely reprogramming a Bluefruit LE module with AdaLink would require four files, and would look something like this (using a JLink):

```
adalink nrf51822 --programmer jlink --wipe
--program-hex "Adafruit_BluefruitLE_Firmware/softdevice/
s110_nrf51_8.0.0_softdevice.hex"
--program-hex "Adafruit_BluefruitLE_Firmware/bootloader/bootloader_0002.hex"
--program-hex "Adafruit_BluefruitLE_Firmware/0.6.7/blefriend32/
blefriend32_s110_xxac_0_6_7_150917_blefriend32.hex"
--program-hex "Adafruit_BluefruitLE_Firmware/0.6.7/blefriend32/
blefriend32_s110_xxac_0_6_7_150917_blefriend32_signature.hex"
```

You can also use the AdaLink tool to get some basic information about your module, such as which SoftDevice is currently programmed or the IC revision (16KB SRAM or 32KB SRAM) via the --info command:

```
$ adalink nrf51822 -p jlink --info
Hardware ID : QFACA10 (32KB)
Segger ID   : nRF51822_xxAC
SD Version  : S110 8.0.0
Device Addr : **:**:**:**:**:**
Device ID   : *****
```

[Adafruit nRF51822 Flasher \(https://adafru.it/fVL\)](https://adafru.it/fVL) (Python)

Adafruit's nRF51822 Flasher is an internal Python tool we use in production to flash boards as they go through the test procedures and off the assembly line, or just testing against different firmware releases when debugging.

It relies on AdaLink or OpenOCD beneath the surface (see above), but you can use this command line tool to flash your nRF51822 with a specific SoftDevice, Bootloader and Bluefruit firmware combination.

It currently supports using either a Segger J-Link or STLink/V2 via AdaLink, or [GPIO on a Raspberry Pi \(https://adafru.it/fVL\)](#) if you don't have access to a traditional ARM SWD debugger. (A pre-built version of OpenOCD for the RPi is included in the repo since building it from scratch takes a long time on the original RPi.)

We don't provide active support for this tool since it's purely an internal project, but made it public just in case it might help an adventurous customer debrick a board on their own.

```
$ python flash.py --jtag=jlink --board=blefriend32 --softdevice=8.0.0 --
bootloader=2 --firmware=0.6.7
jtag      : jlink
softdevice : 8.0.0
bootloader : 2
board     : blefriend32
firmware  : 0.6.7
Writing Softdevice + DFU bootloader + Application to flash memory
adalink -v nrf51822 --programmer jlink --wipe --program-hex
"Adafruit_BluefruitLE_Firmware/softdevice/s110_nrf51_8.0.0_softdevice.hex" --
program-hex "Adafruit_BluefruitLE_Firmware/bootloader/bootloader_0002.hex" --
program-hex "Adafruit_BluefruitLE_Firmware/0.6.7/blefriend32/
blefriend32_s110_xxac_0_6_7_150917_blefriend32.hex" --program-hex
"Adafruit_BluefruitLE_Firmware/0.6.7/blefriend32/
blefriend32_s110_xxac_0_6_7_150917_blefriend32_signature.hex"
...
```

BLE FAQ

Can I talk to Classic Bluetooth devices with a Bluefruit LE modules?

No. Bluetooth Low Energy and 'Classic' Bluetooth are both part of the same Bluetooth Core Specification -- defined and maintained by the Bluetooth SIG -- but they are completely different protocols operating with different physical constraints and requirements. The two protocols can't talk to each other directly.

Can my Bluefruit LE module connect to other Bluefruit LE peripherals

No, the Bluefruit LE firmware from Adafruit is currently peripheral only, and doesn't run in Central mode, which would cause the module to behave similar to your mobile phone or BLE enabled laptop.

If you required Central support, you should look at the newer nRF52832 or nRF52840 based products like the [Adafruit Feather nRF52840 \(https://adafru.it/DLQ\)](#) which contains a SoftDevice which is capable of running in either Central or Peripheral mode. The nRF51832 based products (such as the one used in this

learning guide) are not capable of running in Central mode because it isn't supported by the SoftDevice they use, and it isn't possible to update the SoftDevice safely without special hardware.

I just got my Bluefruit board and when I run a sketch it hangs forever on the 'Connecting...' stage!

There are several possible explanations here, but the first thing to try is to:

1. Disconnect and close the Bluefruit LE Connect app if it's open
2. Disable BLE on your mobile device
3. Restart your Bluefruit sketch and HW
4. Turn BLE back on again (on the mobile device)
5. Open the Bluefruit LE Connect mobile app again and try to connect again

If problems persist, try performing a Factory Reset of your device (see the appropriate learning guide for details on how to do this since it varies from one board to another).

Why are none of my changes persisting when I reset with the sample sketches?

In order to ensure that the Bluefruit LE modules are in a known state for the Adafruit demo sketches, most of them perform a factory reset at the start of the sketch.

This is useful to ensure that the sketch functions properly, but has the side effect of erasing any custom user data in NVM and setting everything back to factory defaults every time your board comes out of reset and the sketch runs.

To disable factory reset, open the demo sketch and find the `FACTORYRESET_ENABLE` flag and set this to '0', which will prevent the factory reset from happening at startup.

If you don't see the 'FACTORYRESET_ENABLE' flag in your .ino sketch file, you probably have an older version of the sketches and may need to update to the latest version via the Arduino library manager.

Do I need CTS and RTS on my UART based Bluefruit LE Module?

Using CTS and RTS isn't strictly necessary when using HW serial, but they should both be used with SW serial, or any time that a lot of data is being transmitted.

The reason behind the need for CTS and RTS is that the UART block on the nRF51822 isn't very robust, and early versions of the chip had an extremely small FIFO meaning that the UART peripheral was quickly overwhelmed.

Using CTS and RTS significantly improves the reliability of the UART connection since these two pins tell the device on the other end when they need to wait while the existing buffered data is processed.

To enable CTS and RTS support, go into the BluefruitConfig.h file in your sketch folder and simply assign an appropriate pin to the macros dedicated to those functions (they may be set to -1 if they aren't currently being used).

Enabling both of these pins should solve any data reliability issues you are having with large commands, or when transmitting a number of commands in a row.

How can I update to the latest Bluefruit LE Firmware?

The easiest way to keep your Bluefruit LE modules up to date is with our [Bluefruit LE Connect app for Android](https://adafru.it/f4G) (<https://adafru.it/f4G>) or [Bluefruit LE Connect for iOS](https://adafru.it/f4H) (<https://adafru.it/f4H>). Both of these apps include a firmware update feature that allows you to automatically download the latest firmware and flash your Bluefruit LE device in as safe and painless a manner as possible. You can also roll back to older versions of the Bluefruit LE firmware using these apps if you need to do some testing on a previous version.

Which firmware version supports 'xxx'?

We regularly release [Bluefruit LE firmware images](https://adafru.it/edX) (<https://adafru.it/edX>) with bug fixes and new features. Each AT command in this learning guide lists the minimum firmware version required to use that command, but for a higher level overview of the changes from one firmware version to the next, consult the [firmware history page](https://adafru.it/iCw) (<https://adafru.it/iCw>).

Does my Bluefruit LE device support ANCS?

ANCS is on the roadmap for us (most likely in the 0.7.x release family), but we don't currently support it since there are some unusual edge cases when implementing it as a service.

My Bluefruit LE device is stuck in DFU mode ... what can I do?

If your device is stuck in DFU mode for some reason and the firmware was corrupted, you have several options.

First, try a factory reset by holding down the DFU button for about 10 seconds until the CONN LED starts flashing, then release the DFU button to perform a factory reset.

If this doesn't work, you may need to reflash your firmware starting from DFU mode, which can be done in one of the following ways:

Bluefruit LE Connect (Android)

- Place the module in DFU mode (constant LED blinky)
- Open Bluefruit LE Connect
- Connect to the 'DfuTarg' device
- Once connected, you will see a screen with some basic device information. Click the '...' in the top-right corner and select Firmware Updates
- Click the Use Custom Firmware button
- Select the appropriate .hex and .init files (copied from the [Bluefruit LE Firmware repo \(https://adafru.it/edX\)](https://adafru.it/edX)) ... for the BLEFRIEND32 firmware version 0.6.7, this would be:
 - Hex File: blefriend32_s110_xxac_0_6_7_150917_blefriend32.hex
 - Init File: blefriend32_s110_xxac_0_6_7_150917_blefriend32_init.dat
- Click Start Update

Unfortunately, the iOS app doesn't yet support custom firmware updates from DFU mode yet, but we will get this into the next release.

Nordic nRF Toolbox

You can also use Nordic's nRF Toolbox application to update the firmware using the OTA bootloader.

On Android:

- Open nRF Toolbox (using the latest version)

- Click the DFU icon
- Click the Select File button
- Select Application from the radio button list, then click OK
- Find the appropriate .hex file
(ex. 'blefriend32_s110_xxac_0_6_7_150917_blefriend32.hex')
- When asked about the 'Init packet', indicate Yes, and select the appropriate *_init.dat file (for example: 'blefriend32_s110_xxac_0_6_7_150917_blefriend32_init.dat').
- Click the Select Device button at the bottom of the main screen and find the DfuTarg device, clicking on it
- Click the Upload button, which should now be enabled on the home screen
- This will begin the DFU update process which should cause the firmware to be updated or restored on your Bluefruit LE module

On iOS:

- Create a .zip file containing the .hex file and init.dat file that you will use for the firmware update. For example:
 - Rename 'blefriend32_s110_xxac_0_6_7_150917_blefriend32.hex' to application.hex
 - Rename 'blefriend32_s110_xxac_0_6_7_150917_blefriend32_init.dat' to application.dat
- Upload the .zip file containing the application.hex and application.dat files to your iPhone using iTunes, as described [here \(https://adafru.it/iCx\)](https://adafru.it/iCx)
- Open the nRF Toolbox app (using the latest version)
- Click the DFU icon
- Click the Select File text label
- Switch to User Files to see the .zip file you uploaded above
- Select the .zip file (ex. blefriend32_065.zip)
- On the main screen select Select File Type
- Select application
- On the main screen select SELECT DEVICE
- Select DfuTarg
- Click the Upload button which should now be enabled
- This will begin the DFU process and your Bluefruit LE module will reset when the update is complete
- If you get the normal 2 or 3 pulse blinky pattern, the update worked!

Adafruit_nRF51822_Flasher

As a last resort, if you have access to a Raspberry Pi, a Segger J-Link or a STLink/V2, you can also try manually reflashing the entire device, as described in the [FAQ above \(https://adafru.it/iCy\)](https://adafru.it/iCy), with further details on the [Software Resources \(https://adafru.it/iCz\)](https://adafru.it/iCz) page.

How do I reflash my Bluefruit LE module over SWD?

Reflashing Bluefruit LE modules over SWD (ex. switching to the sniffer firmware and back) is at your own risk and can lead to a bricked device, and we can't offer any support for this operation! You're on your own here, and there are unfortunately 1,000,000 things that can go wrong, which is why we offer two separate Bluefruit LE Friend boards -- the sniffer and the normal Bluefruit LE Friend board with the non-sniffer firmware, which provides a bootloader with fail safe features that prevents you from ever bricking boards via OTA updates.

AdaLink (SWD/JTAG Debugger Wrapper)

Transitioning between the two board types (sniffer and Bluefruit LE module) is unfortunately not a risk-free operation, and requires external hardware, software and know-how to get right, which is why it isn't covered by our support team.

That said ... if you're determined to go down that lonely road, and you have a [Segger J-Link \(https://adafru.it/fYU\)](https://adafru.it/fYU) (which is what we use internally for production and development), or have already erased your Bluefruit LE device, you should have a look at [AdaLink \(https://adafru.it/fPq\)](https://adafru.it/fPq), which is the tool we use internally to flash the four files required to restore a Bluefruit LE module. (Note: recent version of AdaLink also support the cheaper [STLink/V2 \(http://adafru.it/2548\)](http://adafru.it/2548), though the J-Link is generally more robust if you are going to purchase a debugger for long term use.)

The mandatory Intel Hex files are available in the [Bluefruit LE Firmware repo \(https://adafru.it/edX\)](https://adafru.it/edX). You will need to flash:

- An appropriate bootloader image
- An appropriate SoftDevice image
- The Bluefruit LE firmware image
- The matching signature file containing a CRC check so that the bootloader accepts the firmware image above (located in the same folder as the firmware image)

The appropriate files are generally listed in the [version control .xml file \(https://adafru.it/fPr\)](https://adafru.it/fPr) in the firmware repository.

If you are trying to flash the sniffer firmware (at your own risk!), you only need to flash a single .hex file, which you can find [here \(https://adafru.it/fYV\)](https://adafru.it/fYV). The sniffer doesn't require a SoftDevice image, and doesn't use the fail-safe bootloader -- which is why changing is a one way and risky operation if you don't have a supported SWD debugger.

Adafruit_nF51822_Flasher

We also have an internal python tool available that sits one level higher than AdaLink (referenced above), and makes it easier to flash specific versions of the official firmware to a Bluefruit LE module. For details, see the [Adafruit_nRF51822_Flasher \(https://adafru.it/fVL\)](https://adafru.it/fVL) repo.

Can I access BETA firmware releases?

The latest versions of the Bluefruit LE Connect applications for iOS and Android allow you to optionally update your Bluefruit LE modules with pre-release or BETA firmware.

This functionality is primarily provided as a debug and testing mechanism for support issues in the forum, and should only be used when trying to identify and resolve specific issues with your modules!

Enabling BETA Releases on iOS

- Make sure you have at least version 1.7.1 of Bluefruit LE Connect
- Go to the Settings page
- Scroll to the bottom of the Settings page until you find Bluefruit LE
- Click on the Bluefruit LE icon and enable the Show beta releases switch
- You should be able to see any BETA releases available in the firmware repo now when you use Bluefruit LE Connect

Enabling BETA Releases on Android

- Make sure you have the latest version of Bluefruit LE Connect
- Open the Bluefruit LE Connect application
- Click the "..." icon in the top-right corner of the app's home screen
- Select Settings
- Scroll down to the Software Updates section and enable Show beta releases
- You should be able to see any BETA releases available in the firmware repo now when you use Bluefruit LE Connect

Why can't I see my Bluefruit LE device after upgrading to Android 6.0?

In Android 6.0 there were [some important security changes \(https://adafru.it/jcU\)](https://adafru.it/jcU) that affect Bluetooth Low Energy devices. If location services are unavailable

(meaning the GPS is turned off) you won't be able to see Bluetooth Low Energy devices advertising either. See [this issue \(https://adafru.it/jcV\)](https://adafru.it/jcV) for details.

Be sure to enable location services on your Android 6.0 device when using Bluefruit LE Connect or other Bluetooth Low Energy applications with your Bluefruit LE modules.

What is the theoretical speed limit for BLE?

This depends on a variety of factors, and is determined by the capabilities of the central device (the mobile phone, etc.) as much as the peripheral.

Taking the HW limits on the nRF51822 into account (max 6 packets per connection interval, and a minimum connection interval of 7.5ms) you end up with the following theoretical limits on various mobile operating systems:

- iPhone 5/6 + IOS 8.0/8.1
 $6 \text{ packets} * 20 \text{ bytes} * 1/0.030 \text{ s} = 4 \text{ kB/s} = 32 \text{ kbps}$
- iPhone 5/6 + IOS 8.2/8.3
 $3 \text{ packets} * 20 \text{ bytes} * 1/0.030 \text{ s} = 2 \text{ kB/s} = 16 \text{ kbps}$
- iPhone 5/6 + IOS 8.x with nRF8001
 $1 \text{ packet} * 20 \text{ bytes} * 1/0.030 \text{ s} = 0.67 \text{ kB/s} = 5.3 \text{ kbps}$
- Nexus 4
 $4 \text{ packets} * 20 \text{ bytes} * 1/0.0075 \text{ s} = 10.6 \text{ kB/s} = 84 \text{ kbps}$
- Nordic Master Emulator Firmware (MEFW) with nRF51822 0.9.0
 $1 \text{ packet} * 20 \text{ bytes} * 1/0.0075 = 2.67 \text{ kB/s} = 21.33 \text{ kbps}$
- Nordic Master Emulator Firmware (MEFW) with nRF51822 0.11.0
 $6 \text{ packets} * 20 \text{ bytes} * 1/0.0075 = 16 \text{ kB/s} = 128 \text{ kbps}$

There are also some limits imposed by the Bluefruit LE firmware, but we are actively working to significantly improve the throughput in the upcoming 0.7.0 release, which will be available Q2 2016. The above figures are useful as a theoretical maximum to decide if BLE is appropriate for you project or not.

UPDATE: For more specific details on the limitations of various Android versions and phones, see [this helpful post from Nordic Semiconductors \(https://adafru.it/sKc\)](https://adafru.it/sKc).

Can my Bluefruit board detect other Bluefruit boards or Central devices?

No. All of our Bluefruit LE modules currently operate in peripheral mode, which means they can only advertise their own existence via the advertising payload. The

central device (usually your phone or laptop) is responsible for listening for these advertising packets, starting the connection process, and initiating any transactions between the devices. There is no way for a Bluefruit module to detect other Bluefruit modules or central devices in range, they can only send their own advertising data out and wait for a connection request to come in.

How can I determine the distance between my Bluefruit module and my phone in m/ft?

The short answer is: you can't.

RF devices normally measure signal strength using RSSI, which stands for Received Signal Strength Indicator, which is measured in dBm. The closer the devices are the stronger the RSSI value generally is (-90dBm is much weaker than -60dBm, for example), but there is no reliable relationship between RSSI values in dBm and distance in the real world. If there is a wall between devices, RSSI will fall. If there is a lot of interference on the same 2.4GHz band, RSSI will fall. Depending on the device, if you simply change the antenna orientation, RSSI will fall. You can read the RSSI value between two connected devices with the `AT+BLEGETRSSI` command, but there are no meaningful and repeatable conclusions that can be drawn from this value about distance other than perhaps 'farther' or 'closer' in a very loose sense of the terms.

How far away from my phone can I have my Bluefruit LE module?

This depends on a number of factors beyond the module itself such as antenna orientation, the antenna design on the phone, transmit power on the sending node, competing traffic in the same 2.4GHz bandwidth, obstacles between end points, etc.

It could be as low as a couple meters up to about 10 meters line of sight, but generally Bluetooth Low Energy is designed for very short range and will work best in the 5-6 meter or less range for reliable communication, assuming normal Bluefruit firmware settings.

How many GATT services and characteristics can I create?

For firmware 0.7.0 and higher, the following limitations are present:

- Maximum number of services: 10
- Maximum number of characteristics: 30

- Maximum buffer size for each characteristic: 32 bytes
- Maximum number of CCCDs: 16

Is it possible to modify or disable the built in GATT services and characteristics (DIS, DFU, etc.)?

No, unfortunately you can't. We rely on the [Device Information Service \(https://adafru.it/q9E\)](https://adafru.it/q9E) (DIS) contents to know which firmware and bootloader version you are running, and wouldn't be able to provide firmware updates without being able to trust this information, which is why it's both mandatory and read only.

Similarly, the DFU service is mandatory to maintain over the air updates and disabling it would create more problems than its presence would cause.

How can I use BlueZ and gatttool with Bluefruit modules?

BlueZ has a bit of a learning curve associated with it, but you can find some notes below on one option to send and receive data using the BLE UART Service built into all of our Bluefruit LE modules and boards.

These commands may change with different versions of BlueZ. Version 5.21 was used below.

```
# Initialise the USB dongle
$ sudo hciconfig hci0 up

# Scan for the UART BLE device
$ sudo hcitool lescan
D6:4E:06:4F:72:86 UART

# Start gatttool, pointing to the UART device found above
$ sudo gatttool -b D6:4E:06:4F:72:86 -I -t random --sec-level=high

[D6:4E:06:4F:72:86][LE]> connect
Attempting to connect to D6:4E:06:4F:72:86
Connection successful

# Scan for primary GATT Services
[D6:4E:06:4F:72:86][LE]> primary
attr handle: 0x0001, end grp handle: 0x0007 uuid:
00001800-0000-1000-8000-00805f9b34fb
attr handle: 0x0008, end grp handle: 0x0008 uuid:
00001801-0000-1000-8000-00805f9b34fb
attr handle: 0x0009, end grp handle: 0x000e uuid: 6e400001-b5a3-f393-e0a9-
e50e24dcca9e
attr handle: 0x000f, end grp handle: 0xffff uuid:
0000180a-0000-1000-8000-00805f9b34fb

# Get the handles for the entries in the UART service (handle 0x0009)
[D6:4E:06:4F:72:86][LE]> char-desc
handle: 0x0001, uuid: 00002800-0000-1000-8000-00805f9b34fb
handle: 0x0002, uuid: 00002803-0000-1000-8000-00805f9b34fb
handle: 0x0003, uuid: 00002a00-0000-1000-8000-00805f9b34fb
handle: 0x0004, uuid: 00002803-0000-1000-8000-00805f9b34fb
```

```

handle: 0x0005, uuid: 00002a01-0000-1000-8000-00805f9b34fb
handle: 0x0006, uuid: 00002803-0000-1000-8000-00805f9b34fb
handle: 0x0007, uuid: 00002a04-0000-1000-8000-00805f9b34fb
handle: 0x0008, uuid: 00002800-0000-1000-8000-00805f9b34fb
handle: 0x0009, uuid: 00002800-0000-1000-8000-00805f9b34fb
handle: 0x000a, uuid: 00002803-0000-1000-8000-00805f9b34fb
handle: 0x000b, uuid: 6e400002-b5a3-f393-e0a9-e50e24dcca9e
handle: 0x000c, uuid: 00002803-0000-1000-8000-00805f9b34fb
handle: 0x000d, uuid: 6e400003-b5a3-f393-e0a9-e50e24dcca9e
handle: 0x000e, uuid: 00002902-0000-1000-8000-00805f9b34fb
handle: 0x000f, uuid: 00002800-0000-1000-8000-00805f9b34fb
handle: 0x0010, uuid: 00002803-0000-1000-8000-00805f9b34fb
handle: 0x0011, uuid: 00002a27-0000-1000-8000-00805f9b34fb

# 6e400002 (handle 0x000b) = TX characteristic
# 6e400003 (handle 0x000d) = RX characteristic

# Optional (but maybe helpful) ... scan for CCCD entries
[D6:4E:06:4F:72:86][LE]> char-read-uuid 2902
handle: 0x000e      value: 00 00

# Enable notifications on the RX characteristic (CCCD handle = 0x000e)
# 0100 = get notifications
# 0200 = get indications
# 0300 = get notifications + indications
# 0000 = disable notifications + indications
[D6:4E:06:4F:72:86][LE]> char-write-req 0x000e 0100
Characteristic value was written successfully

# Just to make sure it was updated
[D6:4E:06:4F:72:86][LE]> char-read-hnd 0x000e
Characteristic value/descriptor: 01 00

# Writing "test" in the Serial Monitor of the Arduino sketch should
# cause this output not that notifications are enabled:
Notification handle = 0x000d value: 74 65 73 74

# Write something to the TX characteristic (handle = 0x000b)
# This should cause E F G H to appear in the Serial Monitor
[D6:4E:06:4F:72:86][LE]> char-write-cmd 0x000b 45
[D6:4E:06:4F:72:86][LE]> char-write-cmd 0x000b 46
[D6:4E:06:4F:72:86][LE]> char-write-cmd 0x000b 47
[D6:4E:06:4F:72:86][LE]> char-write-cmd 0x000b 48

# To send multiple bytes
[D6:4E:06:4F:72:86][LE]> char-write-cmd 0x000B 707172737475

# If you are running the callbackEcho sketch and notifications
# are enabled you should get this response after the above cmd:
Notification handle = 0x000d value: 70 71 72 73 74 75

-----

# If you just want to enable constant listening, enter the following command from
the CLI:
$ sudo gatttool -b D6:4E:06:4F:72:86 -t random --char-write-req -a 0x000e -n 0100 --
listen

# This should give us the following output as data is written on the Uno,
# though we can't send anything back:
Characteristic value was written successfully
Notification handle = 0x000d value: 74 65 73 74
Notification handle = 0x000d value: 6d 6f 72 65 20 74 65 73 74

```

Can I use the IRQ pin to wake my MCU up from sleep when BLE UART data is available?

No, on SPI-based boards the IRQ pin is used to indicate that an SDEP response is available to an SDEP command. For example, when you sent the `AT+BLEUARTRX` command as an SDEP message, the Bluefruit firmware running on the nRF51822 will parse the message, prepare an SDEP response, and trigger the IRQ pin to tell the MCU that the response is ready. This is completely independent from the BLE UART service, which doesn't have interrupt capability at present.

Can I also update the sketch running on the device using Bluefruit LE Connect?

No, only the core firmware can be updated over the air. Sketches need to be loaded using the Arduino IDE and serial bootloader.

DFU Bluefruit Updates

For videos on the latest update procedure using Bluefruit LE Connect see:

- iOS: <https://learn.adafruit.com/introducing-adafruit-ble-bluetooth-low-energy-friend/dfu-on-ios> (<https://adafru.it/iCx>)
- Android: <https://learn.adafruit.com/introducing-adafruit-ble-bluetooth-low-energy-friend/dfu-on-android-4-dot-3-plus> (<https://adafru.it/oSD>)

The video below is out of date and applies to early versions of the board before the Bluefruit LE Connect apps were available for iOS, Android and OS X in the respective app stores. To keep your device up to date, simply install and open the Bluefruit LE Connect app and connect to your Bluefruit device. If a firmware update is available, it will be automatically proposed, and the entire update process will be handled transparently for you.

You can reprogram the Bluefruit LE module itself over-the-air using an Android or iOS phone/tablet. This doesn't reprogram the ATmega32u4 in the Bluefruit Micro, only the BLE module itself. Since its not a common thing to do, its a little challenging to do.

You will need to disconnect/unpower the Bluefruit Micro, connect a wire temporarily between the DFU pin and GND and then power up the board via USB or battery.

The red LED will blink continuously, letting you know it's in DFU mode. [Then follow our guide for field updating the firmware](https://adafruit.it/iCQ) (<https://adafruit.it/iCQ>)

Downloads

- [PCB Files on GitHub](https://adafruit.it/nQD) (<https://adafruit.it/nQD>)
- [MDBT Datasheet](https://adafruit.it/oYE) (<https://adafruit.it/oYE>)
- [Fritzing object available in the Adafruit Fritzing Library](https://adafruit.it/aP3) (<https://adafruit.it/aP3>)
- [PDF for Feather 32u4 Bluefruit LE Board Diagram on GitHub](https://adafruit.it/ZBb) (<https://adafruit.it/ZBb>)

SVG for Feather 32u4 Bluefruit LE Board Diagram

<https://adafruit.it/ZBc>

Schematic

Click to embiggen

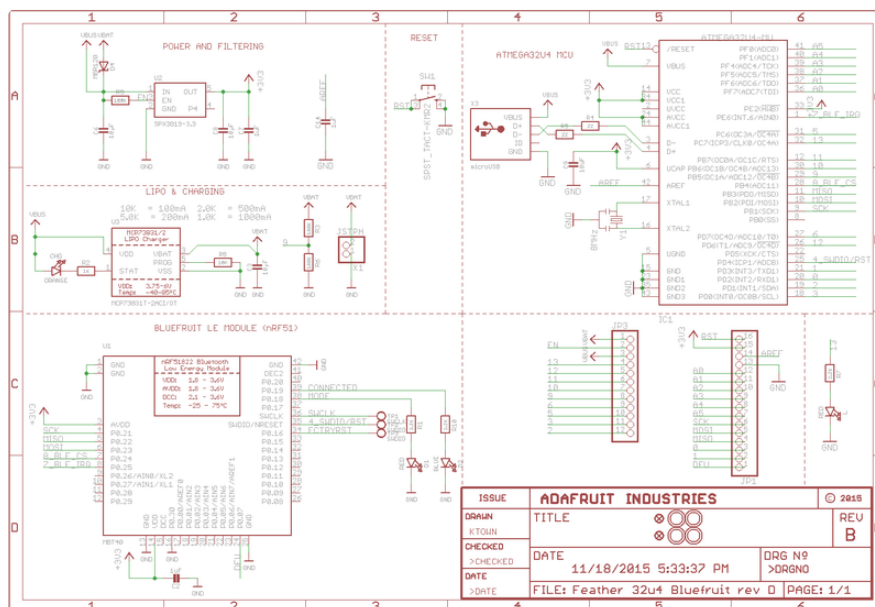

We've changed the regulator from an SPX3819 to AP2112 - it has lower dropout but cannot handle higher than 6V

Remove the jumper cable between DFU and GND once you are in DFU mode so that you exit it during the next reset!

2. Update the Bluefruit Firmware

Next, update your device to the latest Bluefruit firmware using the Bluefruit LE Connect app. We regularly fix bugs, and it's always a good idea to be on the latest release.

You can perform a firmware update in DFU mode, although the Bluefruit board may appear as DfuTarg in the Bluefruit LE Connect app, and you will need to select the right firmware 'family' for your board.

Because bootloader mode is a fail safe mode and has a small subset of Bluefruit's features, we can't tell the Bluefruit LE Connect app very many details about our HW. As such, you will need to indicate which firmware type to flash ... specifically, whether to flash the UART or SPI based firmware. Be sure to select the right one, based on your product and the table below:

BLEFRIEND32 Firmware (UART, 32KB SRAM)

- [Bluefruit UART Friend V2 \(https://adafru.it/edl\)](https://adafru.it/edl)
- [Bluefruit LE UART Friend \(https://adafru.it/tYD\)](https://adafru.it/tYD)

BLESPIFRIEND Firmware (SPI)

- [Bluefruit LE SPI Friend \(https://adafru.it/fLp\)](https://adafru.it/fLp)
- [Bluefruit LE Shield \(http://adafru.it/2746\)](http://adafru.it/2746)
- [Bluefruit LE Micro \(https://adafru.it/tYE\)](https://adafru.it/tYE)
- [Feather 32u4 Bluefruit LE \(https://adafru.it/tYF\)](https://adafru.it/tYF)
- [Feather M0 Bluefruit LE \(http://adafru.it/2995\)](http://adafru.it/2995)

3. Flash a Test Sketch

Once the core Bluefruit firmware has been updated, flash a test sketch to the device from the Arduino IDE, such as the following blinky code:

```
// the setup function runs once when you press reset or power the board
void setup() {
  // initialize digital pin LED_BUILTIN as an output.
  pinMode(LED_BUILTIN, OUTPUT);
}
```



```
}  
  
// the loop function runs over and over again forever  
void loop() {  
  digitalWrite(LED_BUILTIN, HIGH); // turn the LED on (HIGH is the voltage level)  
  delay(1000); // wait for a second  
  digitalWrite(LED_BUILTIN, LOW); // turn the LED off by making the voltage LOW  
  delay(1000); // wait for a second  
}
```

4. Perform a Factory Reset

Once the core Bluefruit firmware has been updated, the final step is to perform a factory reset.

- With the board still powered up, connect the DFU pin to GND
- Leave the pin set to GND (or hold the DFU button down) for >5 seconds until the BLUE status LED starts to blink
- Remove the DFU jumper cable or release the DFU button

This will cause a factory reset which will wipe all config data, and should restore your board, getting you back to a normal state in most situations!

Still Having Problems?

Hop on over to our [support forums \(https://adafru.it/dYq\)](https://adafru.it/dYq) clearly explaining your problem along with the following information, and, we'll be happy to help:

- Your product name and ideally the product ID
- The Bluefruit firmware version you are using (available at the top of the Serial Monitor output on most example sketches)
- The Operating System you are using
- The Arduino IDE version you are using

Providing the above information in your first post will skip a round of two of back and forth and you'll get an answer from us quicker, saving everyone time and effort!

Be sure to see the FAQ section of this learning guide as well, which has answer to many common problems!

Feather HELP!

Even though this FAQ is labeled for Feather, the questions apply to ItsyBitsy's as well!

My ItsyBitsy/Feather stopped working when I unplugged the USB!

A lot of our example sketches have a

```
while (!Serial);
```

line in setup(), to keep the board waiting until the USB is opened. This makes it a lot easier to debug a program because you get to see all the USB data output. If you want to run your Feather without USB connectivity, delete or comment out that line

My Feather never shows up as a COM or Serial port in the Arduino IDE

A vast number of Itsy/Feather 'failures' are due to charge-only USB cables

We get upwards of 5 complaints a day that turn out to be due to charge-only cables!

Use only a cable that you know is for data syncing

If you have any charge-only cables, cut them in half throw them out. We are serious! They tend to be low quality in general, and will only confuse you and others later, just get a good data+charge USB cable.

A quality USB port is critical. Avoid plugging into USB keyboards and when possible use a USB-2 HUB to avoid USB3 issues.

Ack! I "did something" and now when I plug in the Itsy/ Feather, it doesn't show up as a device anymore so I cant upload to it or fix it...

No problem! You can 'repair' a bad code upload easily. Note that this can happen if you set a watchdog timer or sleep mode that stops USB, or any sketch that 'crashes' your board

1. Turn on verbose upload in the Arduino IDE preferences
 2. Plug in Itsy or Feather 32u4/M0, it won't show up as a COM/serial port that's ok
 3. Open up the Blink example (Examples->Basics->Blink)
 4. Select the correct board in the Tools menu, e.g. Feather 32u4, Feather M0, Itsy 32u4 or M0 (physically check your board to make sure you have the right one selected!)
 5. Compile it (make sure that works)
 6. Click Upload to attempt to upload the code
 7. The IDE will print out a bunch of COM Ports as it tries to upload. During this time, double-click the reset button, you'll see the red pulsing LED that tells you its now in bootloading mode
 8. The board will show up as the Bootloader COM/Serial port
 9. The IDE should see the bootloader COM/Serial port and upload properly
-

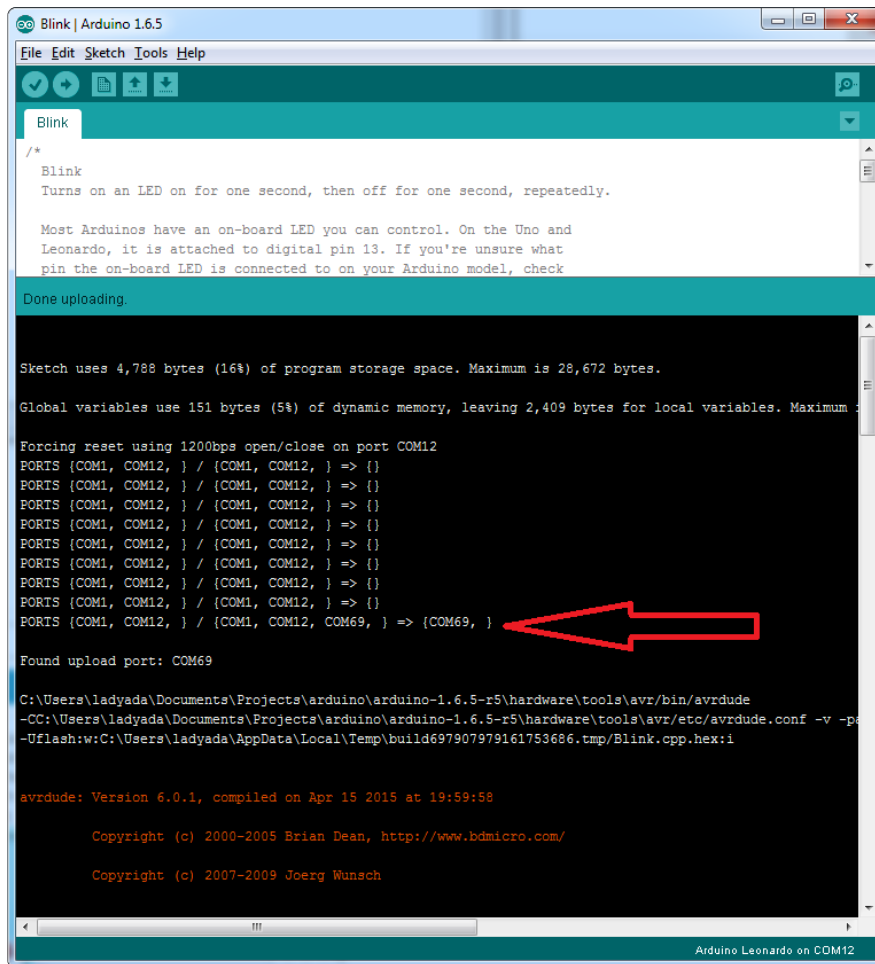

I can't get the Itsy/Feather USB device to show up - I get "USB Device Malfunctioning" errors!

This seems to happen when people select the wrong board from the Arduino Boards menu.

If you have a Feather 32u4 (look on the board to read what it is you have) Make sure you select Feather 32u4 for ATmega32u4 based boards! Do not use anything else, do not use the 32u4 breakout board line.

If you have a Feather M0 (look on the board to read what it is you have) Make sure you select Feather M0 - do not use 32u4 or Arduino Zero

If you have a ItsyBitsy M0 (look on the board to read what it is you have) Make sure you select ItsyBitsy M0 - do not use 32u4 or Arduino Zero

I'm having problems with COM ports and my Itsy/Feather 32u4/M0

There are two COM ports you can have with the 32u4/M0, one is the user port and one is the bootloader port. They are not the same COM port number!

When you upload a new user program it will come up with a user com port, particularly if you use Serial in your user program.

If you crash your user program, or have a program that halts or otherwise fails, the user COM port can disappear.

When the user COM port disappears, Arduino will not be able to automatically start the bootloader and upload new software.

So you will need to help it by performing the click-during upload procedure to re-start the bootloader, and upload something that is known working like "Blink"

I don't understand why the COM port disappears, this does not happen on my Arduino UNO!

UNO-type Arduinos have a separate serial port chip (aka "FTDI chip" or "Prolific PL2303" etc etc) which handles all serial port capability separately than the main chip. This way if the main chip fails, you can always use the COM port.

M0 and 32u4-based Arduinos do not have a separate chip, instead the main processor performs this task for you. It allows for a lower cost, higher power setup...but requires a little more effort since you will need to 'kick' into the bootloader manually once in a while

I'm trying to upload to my 32u4, getting "avrdude: butterfly_recv(): programmer is not responding" errors

This is likely because the bootloader is not kicking in and you are accidentally trying to upload to the wrong COM port

The best solution is what is detailed above: manually upload Blink or a similar working sketch by hand by manually launching the bootloader

I'm trying to upload to my Feather M0, and I get this error "Connecting to programmer: .avrdude: butterfly_recv(): programmer is not responding"

You probably don't have Feather M0 selected in the boards drop-down. Make sure you selected Feather M0.

I'm trying to upload to my Feather and i get this error "avrdude: ser_recv(): programmer is not responding"

You probably don't have Feather M0 / Feather 32u4 selected in the boards drop-down. Make sure you selected Feather M0 (or Feather 32u4).

I attached some wings to my Feather and now I can't read the battery voltage!

Make sure your Wing doesn't use pin #9 which is the analog sense for the lipo battery!

The yellow LED Is flickering on my Feather, but no battery is plugged in, why is that?

The charge LED is automatically driven by the Lipoly charger circuit. It will try to detect a battery and is expecting one to be attached. If there isn't one it may flicker once in a while when you use power because it's trying to charge a (non-existent) battery.

It's not harmful, and its totally normal!

The Arduino IDE gives me "Device Descriptor Request Failed"

This can require "manual bootloading".

If you ever get in a 'weird' spot with the bootloader, or you have uploaded code that crashes and doesn't auto-reboot into the bootloader, double-click the RST button to get back into the bootloader. The red LED will pulse, so you know that its in bootloader mode. Do the reset button double-press right as the Arduino IDE says its attempting to upload the sketch, when you see the Yellow Arrow lit and the Uploading ... text in the status bar.

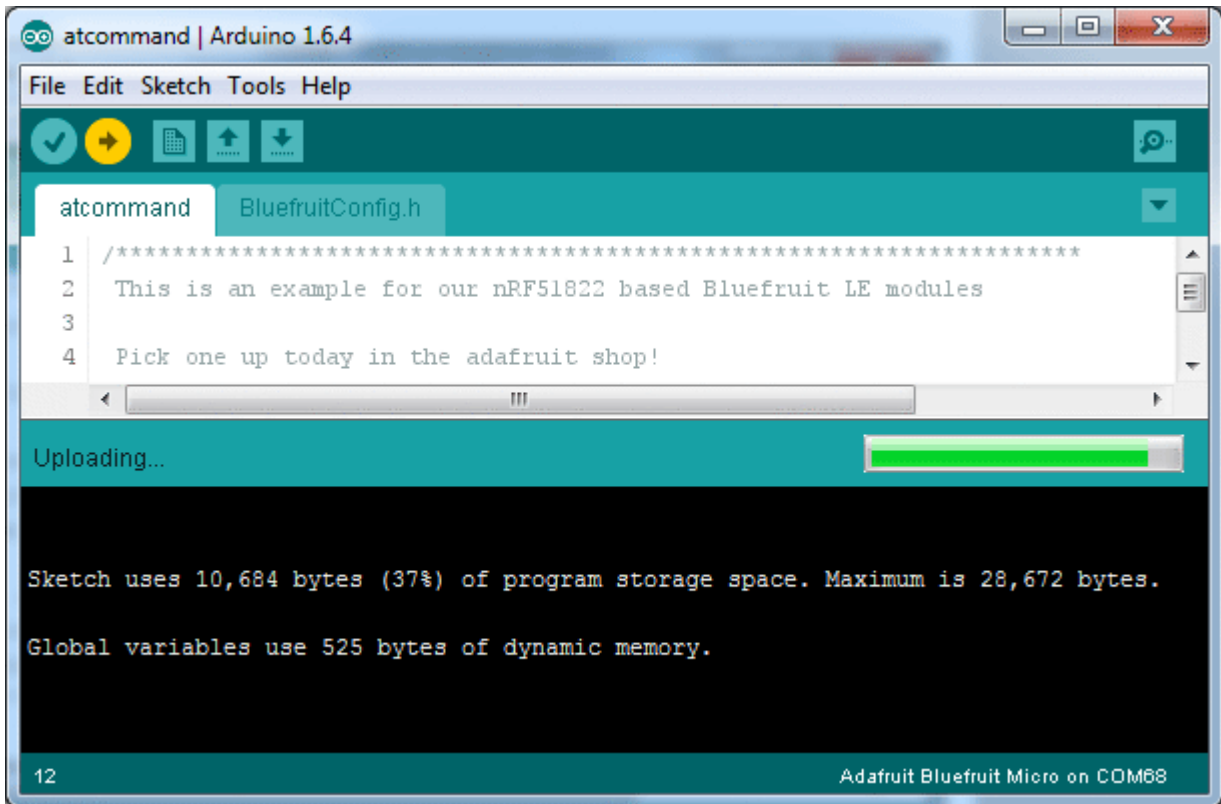

(h

<https://adafru.it/UJA>

Don't click the reset button before uploading, unlike other bootloaders you want this one to run at the time Arduino is trying to upload