

RYUW122

UART Interface

6.5 GHz and 8 GHz UWB Antenna Transceiver Module

Datasheet



PRODUCT DESCRIPTION

REYAX RYUW122 is designed as smart algorithm and high quality UWB(Ultra Wide Band) module, It is good for secure and precise distance measurement.

FEATURES

- Supports IEEE802.15.4-2015 UWB & IEEE802.15.4z (BPRF mode)
- Supports channels 5 & 9 (6489.6MHz & 7987.2 MHz)
- Worldwide UWB Radio Regulatory compliance
- Location to an accuracy of 10 cm
- Control easily by AT commands
- Provides precision location and data transfer simultaneously
- Designed with integrated antenna
- Integrated AES 128

APPLICATIONS

- Distance Measurement.
- Precision real time location systems (RTLS) using two-way ranging.
- Location aware wireless sensor Networks
- 2D / 3D positioning.

BLOCK DIAGRAM

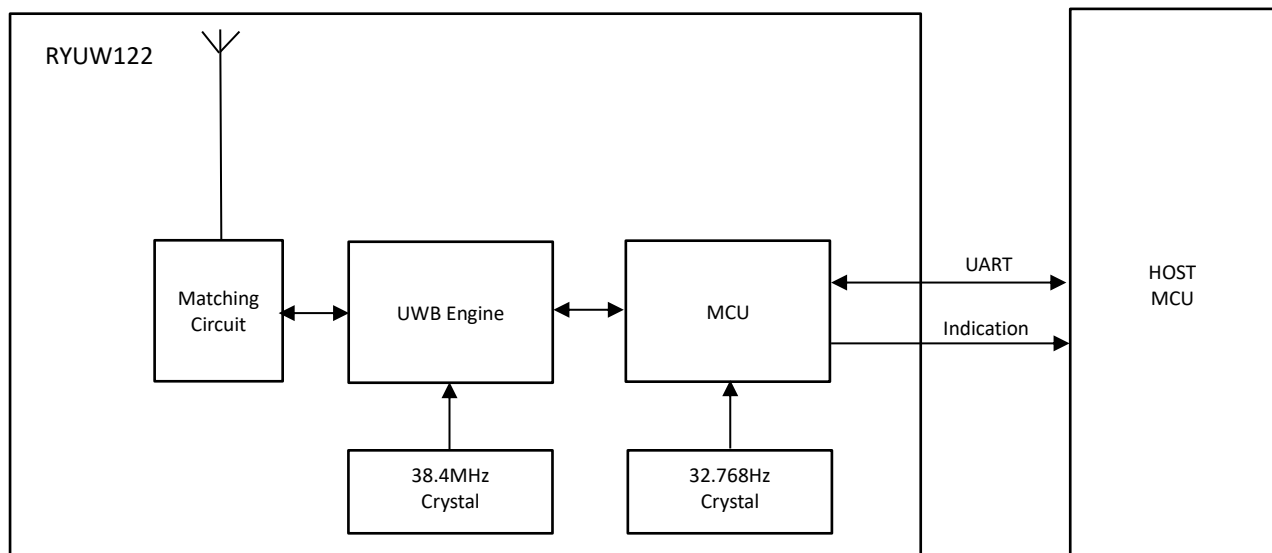

PIN DESCRIPTION

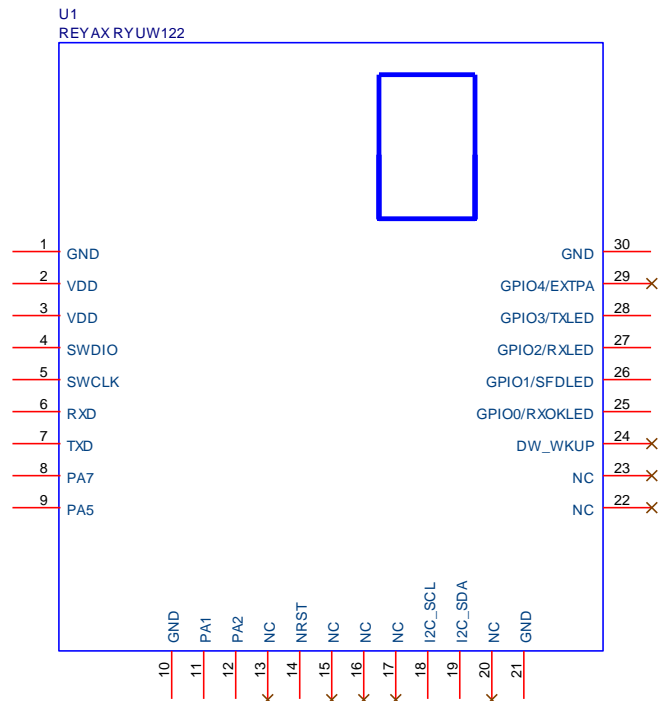

Pin	Name	I/O	Condition
1	GND	-	Ground
2	VDD	P	Power supply
3	VDD	P	Power supply
4	SWDIO	I/O	Not Connected, Reserved for future applications
5	SWCLK	I/O	Not Connected, Reserved for future applications
6	RXD	I	UART Data Input
7	TXD	O	UART Data Output
8	PA7	O	Mode Indicator Hi : Normal mode, Low : Sleep mode.
9	PA5	I/O	Not Connected, Reserved for future applications
10	GND	-	Ground
11	PA1	I/O	Not Connected, Reserved for future applications
12	PA2	I/O	Not Connected, Reserved for future applications
13	NC		Not Connected.
14	NRST	I	Low reset trigger input
15	NC		Not Connected.
16	NC		Not Connected.
17	NC		Not Connected.
18	I2C_SCL	I/O	Not Connected, Reserved for future applications

SPECIFICATION

Item	Min.	Typical	Max.	Unit	Condition
VDD Power Supply	2.4	3.3	3.6	V	VDD
RF Output Power Range		-32		dBm	
RF Sensitivity		-100		dBm	
RF Input Level			14	dBm	
Frequency Range		6489.6 7987.2		MHz	Channel 5 Channel 9
Data rate		850 6.8		Kbps Mbps	
Location accuracy		10		cm	Open Field Environment
Frequency Accuracy		±10		ppm	
Communication Range		100		M	RYUW122 to RYUW122 Open Field Environment
ANCHOR mode Current		8		mA	
TAG mode Current		81		mA	
RF Transmit current		86		mA	
RF disable Current		4		uA	
Sleep mode Current		2		uA	
Baud rate	9600	115200	115200	bps	8, N, 1
Anchor to TAG response time		50		ms	AT+ANCHOR_SEND Command
Digital Input Level High	0.7*VDD		VDD	V	VIH
Digital Input Level Low	0		0.3*VDD	V	VIL
Digital Output Level High	0.9		VDD	V	VOH
Digital Output Level Low			0.1	V	VOL
Cycling (erase / write) Flash data memory		100		K	Cycles
Weight		1		g	
Operating Temperature	-40	25	+85	°C	

3D RADIATION GAIN PATTERN

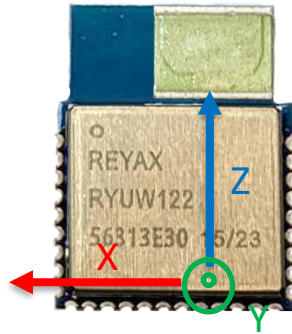

@6.5GHz (unit : dBi)

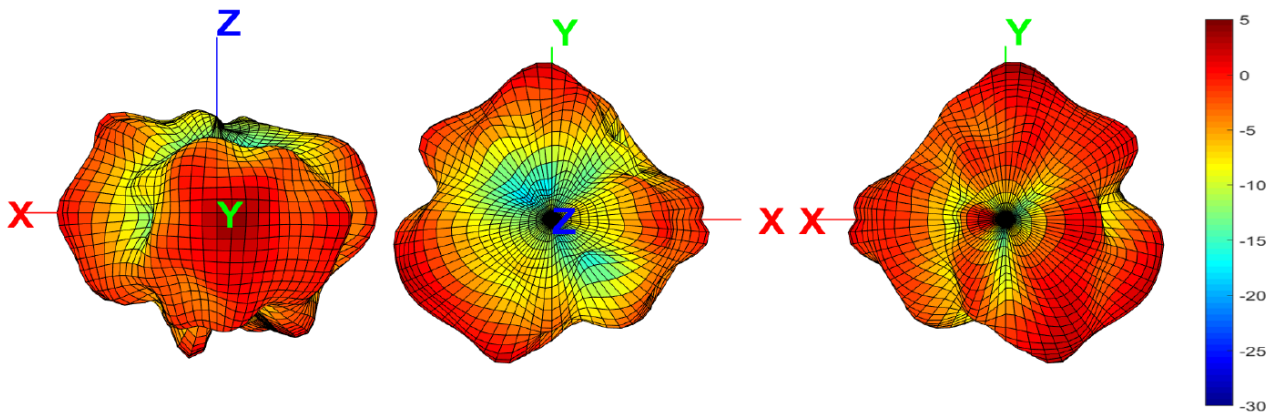

@8GHz (unit : dBi)

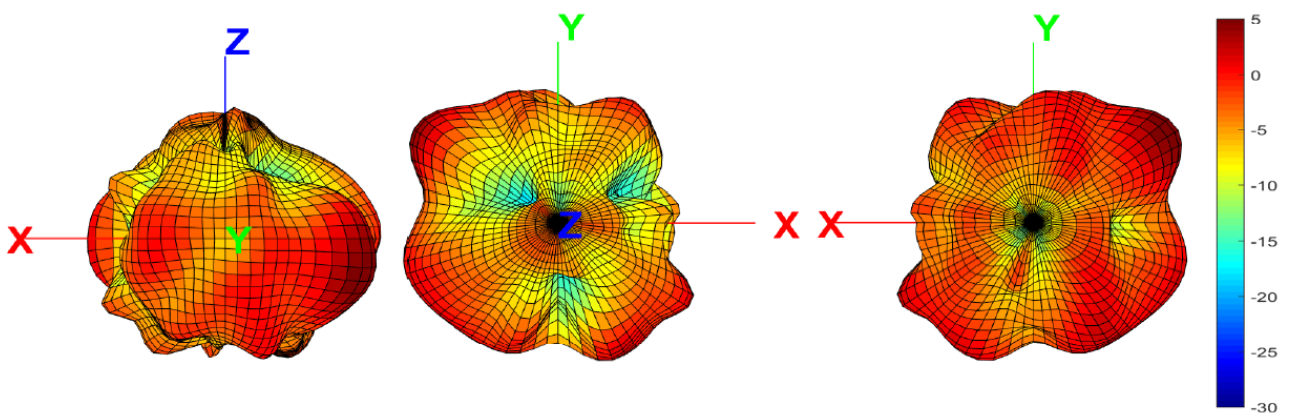

REFLOW SOLDERING

Consider the "IPC-7530 Guidelines for temperature profiling for mass soldering (reflow and wave) processes, published 2001. **Only single reflow soldering processes are recommended for REYAX modules. Repeated reflow soldering processes and soldering the module upside down are not recommended.**

Preheat phase

Initial heating of component leads and balls. Residual humidity will be dried out. Please note that this preheat phase will not replace prior baking procedures.

- Temperature rise rate: max. 3 °C/s If the temperature rise is too rapid in the preheat phase it may cause excessive slumping.
- Time: 60 - 120 s If the preheat is insufficient, rather large solder balls tend to be generated. Conversely, if performed excessively, fine balls and large balls will be generated in clusters.
- End Temperature: 150 - 200 °C If the temperature is too low, non-melting tends to be caused in areas containing large heat capacity.

Heating/ Reflow phase

The temperature rises above the liquidus temperature of 217°C. Avoid a sudden rise in temperature as the slump of the paste could become worse.

- Limit time above 217 °C liquidus temperature: 40 - 60 s
- Peak reflow temperature: 245 °C

Cooling phase

A controlled cooling avoids negative metallurgical effects (solder becomes more brittle) of the solder and possible mechanical tensions in the products. Controlled cooling helps to achieve bright solder fillets with a good shape and low contact angle.

- Temperature fall rate: max 4 °C/s To avoid falling off, the REYAX module should be placed on the topside of the motherboard during soldering.

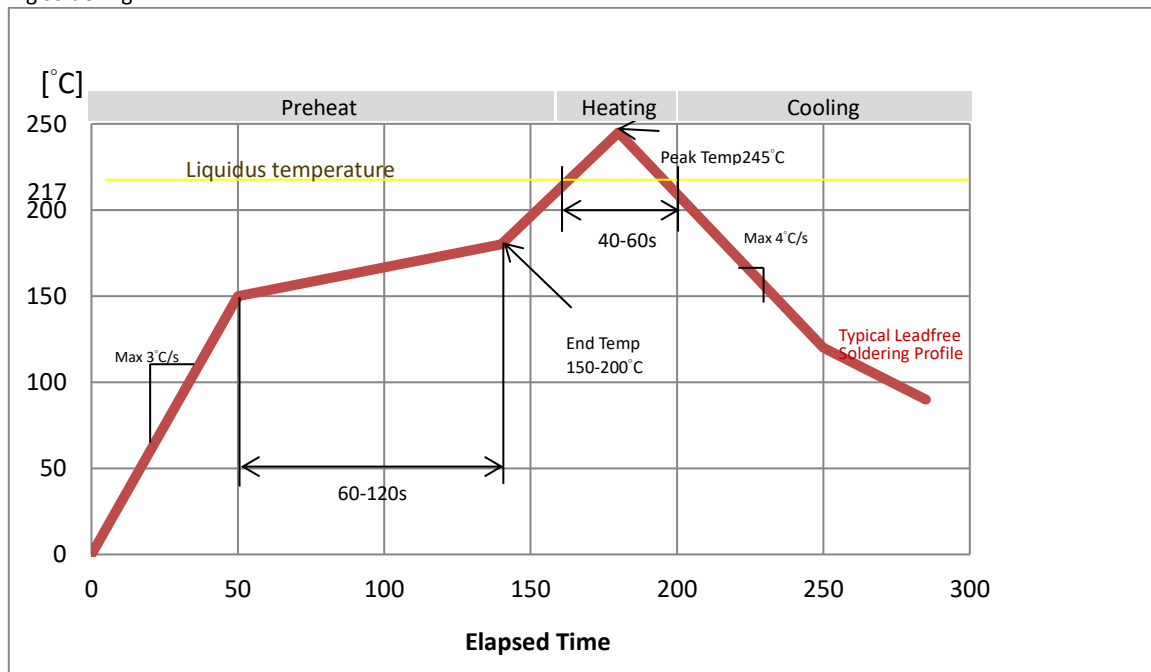

Recommended soldering profile

DIMENSIONS

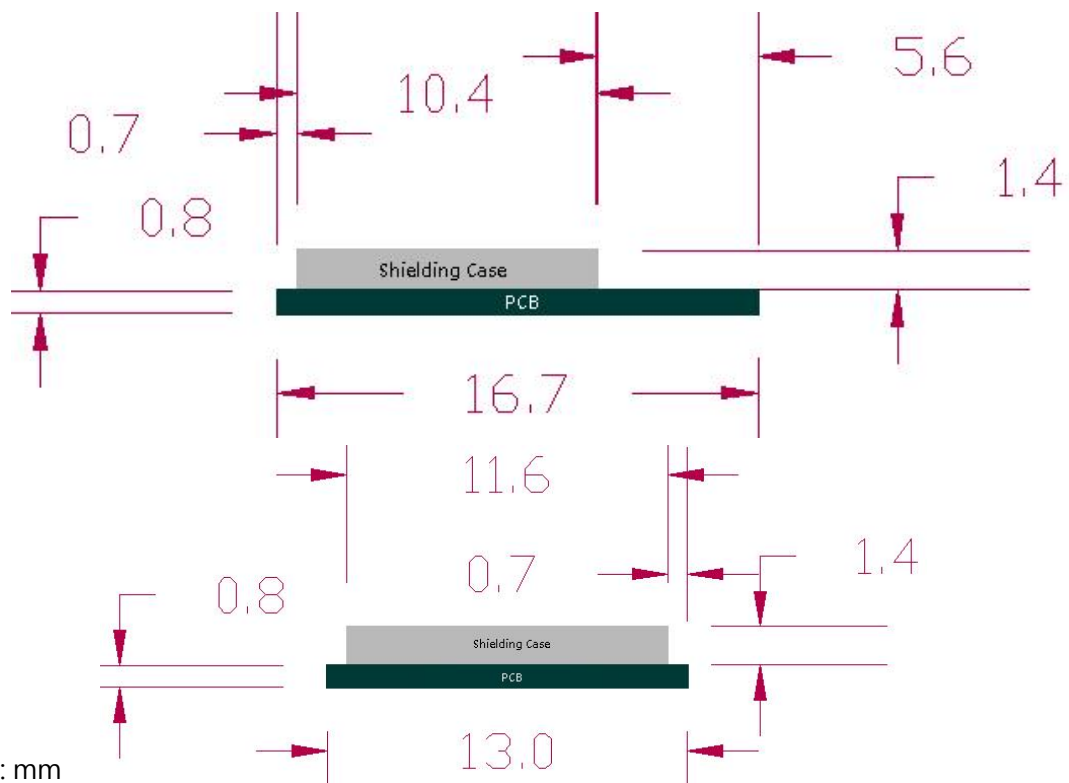
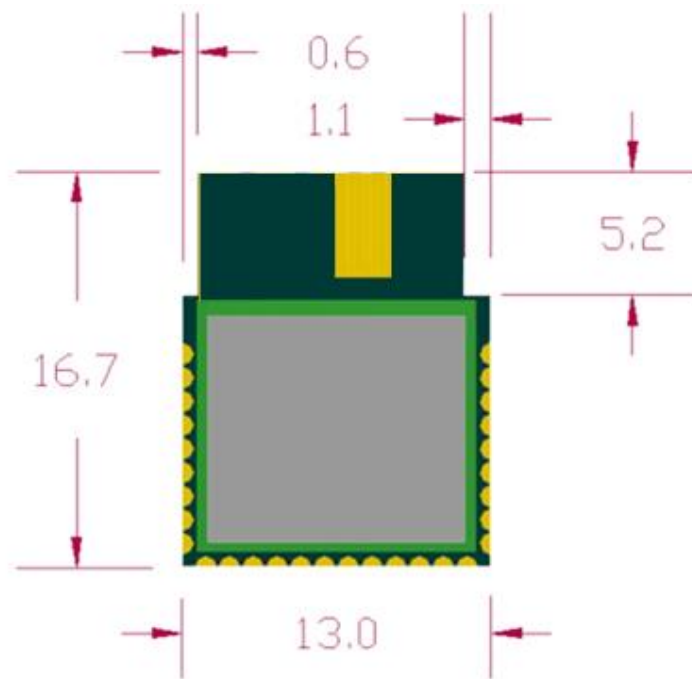

Unit : mm

LAYOUT FOOTPRINT RECOMMENDATIONS

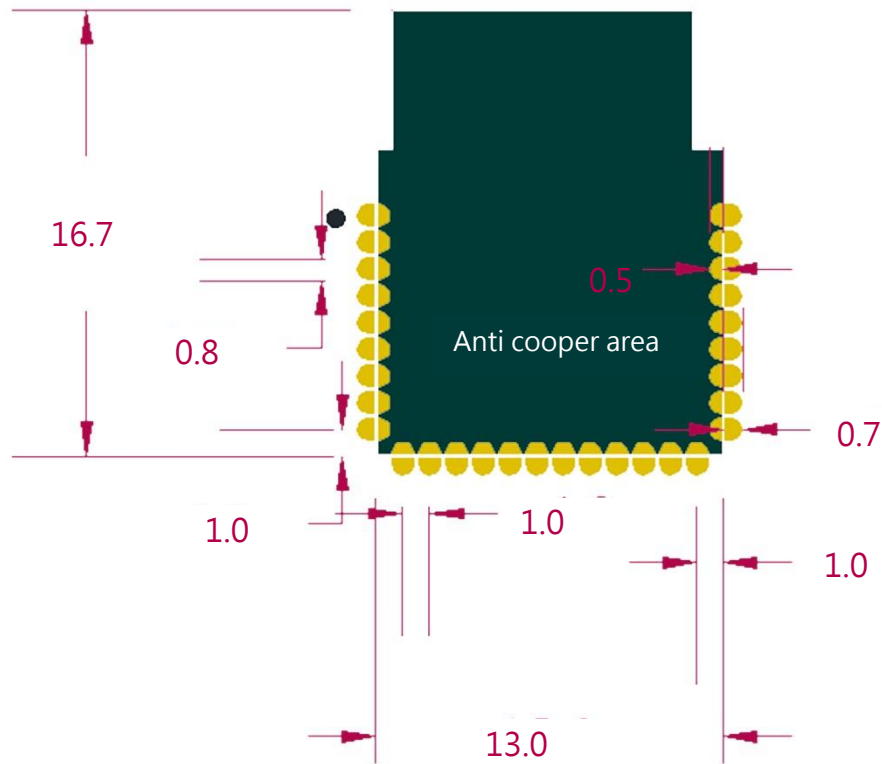

Unit : mm

REYAX
TECHNOLOGY CORPORATION, LTD

E-mail: sales@reyax.com
Website: <http://reyax.com>